



Planning Act 2008
Infrastructure Planning
(Applications Prescribed
Forms and Procedure)
Regulations 2009
APFP Reg. 5(2)(a)

Infrastructure
(Environmental Impact
Assessment)
Regulations 2017

North Lincolnshire Green Energy Park

Volume 6

Environmental Statement

6.2.13 Traffic and Transport

PINS reference: EN010116

May 2022

Revision number: 0



CONTENTS

1.	INTRODUCTION	1
2.	POLICY CONTEXT, LEGISLATION, GUIDANCE AND STANDARDS	2
2.2	National Policy	2
2.2.1	Department for Transport Strategic Road Network Guidance (DfT Circular 02/2013) ..	2
2.2.2	Overarching National Policy Statement for Energy EN-1 (DECC 2011)	2
2.2.3	NPS for Renewable Energy Infrastructure EN-3 (DECC 2011)	3
2.2.4	National Planning Policy Framework (MHCLG, 2021)	4
2.3	Local Policy	5
2.3.1	North Lincolnshire Local Plan (2003) Saved Policies (2007)	5
2.3.2	North Lincolnshire Local Development Framework – Core Strategy (2011)	7
2.3.3	Emerging North Lincolnshire Local Plan (2022 / 2023)	7
2.4	Guidance	8
2.4.1	IEMA Guidelines for the Environmental Assessment of Road Traffic	8
2.4.2	Port Marine Safety Code, DfT/MCA Nov 2016	8
2.4.3	A Guide to Good Practice on Port Marine Operations, DfT/MCA Feb 2018	8
3.	CONSULTATION	9
4.	ASSESSMENT PARAMETERS	28
4.1	Construction Phase	28
4.2	Operational Phase	29
4.2.2	Proposed New Access Road and Stopping Up of Stather Road	30
4.2.3	NLGEP Freight Transport	30
4.2.4	NLGEP Employee Trips	32
4.2.5	NLGEP Other Vehicle Trips	33
4.2.6	Total Vehicle Trips	34
4.3	Study Area	34
5.	ASSESSMENT METHODOLOGY AND SIGNIFICANCE CRITERIA	36
5.1	EIA Scoping	36
5.2	Baseline Study Methodology	36
5.3	Assessment Approach	37
5.4	Assessment of Effects	38
5.4.2	Receptor Sensitivity	39
5.4.3	Magnitude of Change	40
5.4.4	Severance	40
5.4.5	Pedestrian/Cycle Delay	40
5.4.6	Pedestrian/Cycle Amenity	41
5.4.7	Driver Delay	41
5.4.8	Highway Safety	42
5.4.9	Public Transport	42
5.4.10	Significance Evaluation	43
5.4.11	Assessment limitations (technical deficiencies or lack of knowledge)	44
6.	BASELINE AND RECEPTORS	45
6.1	Current Baseline (2022)	45
6.1.1	Local Highway Network	45
6.1.2	Walking and Cycling	45
6.1.3	Public Transport	46
6.1.4	Highway Safety	49
6.1.5	Freight Transport by River	49
6.1.6	Freight Transport by Rail	50
6.2	Future Baseline (2028)	50

6.3	Identified Sensitive Receptors	51
7.	MITIGATION	53
7.2	Construction Phase	53
7.3	Operational Phase	54
8.	ASSESSMENT OF LIKELY EFFECTS	56
8.1	Demolition and Construction Effects	56
8.1.1	Local Highway Network	56
8.1.2	Freight Transport by River	66
8.1.3	Freight Transport by Rail	66
8.1.4	Climate Change and Adaption	67
8.1.5	Summary of Demolition and Construction Effects.....	67
8.2	Operational Effects	70
8.2.1	Local Highway Network	70
8.2.2	Pedestrians and Cyclists.....	74
8.2.3	Highway Safety	76
8.2.4	Public Transport.....	76
8.2.5	Freight Transport by River	76
8.2.6	Freight Transport by Rail	77
8.2.7	Climate Change and Adaptation	78
8.2.8	Summary of Operational Effects	79
9.	CONCLUSIONS	81
9.1	Demolition and Construction.....	81
9.2	Operational	81
10.	REFERENCES	83

APPENDIX A FIGURES

APPENDIX B TRANSPORT ASSESSMENT (TA)

APPENDIX C FRAMEWORK TRAVEL PLAN

APPENDIX D OUTLINE CONSTRUCTION LOGISTICS PLAN

List of Tables

Table 1: Scoping Consultation Responses	9
Table 2: Section 42 and Section 47 Consultation Responses on the PEIR	12
Table 3: Cumulative Schemes included in the Transport Assessment	29
Table 4: NLGEP - Total Employees	32
Table 5: Mode Split of Travel	33
Table 6: NLGEP – Employee Trips by Mode	33
Table 7: NLGEP – Total Vehicle Trips	34
Table 8: Highway Links included in the Study Area.....	34
Table 9: Criteria for Determining Receptor / Road User Sensitivity.....	39
Table 10: Criteria for determining magnitude of change/impact.....	42
Table 10: Matrix for determining Effect Significance	43
Table 11: Bus Routes and Service Frequencies.....	47
Table 12: Train Frequencies at Scunthorpe and Althorpe Stations	48
Table 13: Highway Links and their Sensitivity.....	51
Table 14: Peak Construction Traffic per Year.....	57
Table 15: 2025 Construction Traffic Flows (Annual Average Daily Traffic (AADT))	58
Table 16: 2025 Construction Traffic Flows (Annual Average Weekly Traffic (AAWT))	59

Table 17: 2026 Construction Traffic Flows (AADT)	60
Table 18: 2026 Construction Traffic Flows (AAWT)	62
Table 19: Summary of Effects during Demolition and Construction	68
Table 20: 2028 Operational Traffic Flows (AADT).....	71
Table 21: 2028 Operational Traffic Flows (AAWT).....	72
Table 22: Increase in Walking Trips.....	75
Table 23: Increase in Cycling Trips.....	75
Table 24: Summary of Operational Effects	80

List of Figures

Figure 1: NLGEP – Number of Employees at the Project for typical working day.....	32
Figure 2: Sensitive Locations	85
Figure 3: Local Highway Network	86
Figure 4: Existing Pedestrian / Cycling Infrastructure.....	87
Figure 5: Walking Isochrones.....	88
Figure 6: Cycling Isochrones.....	89
Figure 7: Local Freight Rail Network.....	90

Acronyms and Abbreviations

Name	Description
AADT / AAWT	Annual Average Daily/Weekday Traffic
ABP	Associated British Ports
AIL	Abnormal Indivisible Load
CEMP	Construction Environmental Management Plan
CLP	Construction Logistics Plan
CO ₂	Carbon Dioxide
CoCP	Code of Construction Practice
CTMP	Construction Traffic Management Plan
CWTP	Construction Workers Travel Plan
DCO	Development Consent Order
DECC	Department of Energy and Climate Change
DfT	Department for Transport
DHPWN	District Heat and Private Wire Networks
DoS	Degree of Saturation
EIA	Environmental Impact Assessment
ERF	Energy Recovery Facility
ES	Environmental Statement
FORS	Freight Operator Recognition Scheme
HGV	Heavy Goods Vehicle
IEMA	Institute of Environmental Management and Assessment
IPC	Infrastructure Planning Commission
LDF	Local Development Framework

Name	Description
LGV	Light Goods Vehicle
MCA	Maritime & Coastguard Agency
MHCLG	Ministry for Housing, Communities and Local Government
NLC	North Lincolnshire Council
NLGEP	North Lincolnshire Green Energy Park
NLSRN	North Lincolnshire Strategic Road Network
NPPF	National Planning Policy Framework
NPS	National Policy Statement
NRA	Navigation Risk Assessment
NSIP	Nationally Significant Infrastructure Project
NT	Northern Trains
PEIR	Preliminary Environmental Information Report
PINS	Planning Inspectorate
PRoW	Public Right of Way
RFC	Ratio of Flow to Capacity
RDF	Refuse Derived Fuel
ROR	Rail Operations Report
SMS	Safety Management System
SRN	Strategic Road Network
TA	Transport Assessment
TP	Travel Plan
TPE	TransPennine Express
UK	United Kingdom



1. INTRODUCTION

1.1.1.1 This chapter of the Environmental Statement (ES) assesses the likely environmental effects of the Project with respect to traffic and transport. This chapter also describes the methods used to assess the effects; the baseline conditions currently existing at the Project and surrounding area; the mitigation measures required to prevent, reduce or offset any significant adverse effects; and the likely residual effects after these measures have been adopted.

1.1.1.2 This chapter has been informed by the Transport Assessment (TA), Operational Workplace Travel Plan (TP) and outline Construction Logistics Plan (CLP) for the Project, which are included at Appendices B – D of this chapter.

2. POLICY CONTEXT, LEGISLATION, GUIDANCE AND STANDARDS

2.1.1.1 A review has been undertaken of general planning and strategic policy and guidance such as national policy documents, Local Development Frameworks (LDF) and community strategies. This is presented in Chapter 2 of the ES (**Document Reference 6.2.2**). The policy context of greatest relevance to Traffic and Transport is summarised below.

2.2 National Policy

2.2.1 *Department for Transport Strategic Road Network Guidance (DfT Circular 02/2013)*

2.2.1.1 DfT Circular 02/2013 'The Strategic Road Network and the Delivery of Sustainable Development' sets out the way in which National Highways (formerly known as Highways England) 'will engage with communities and the development industry to deliver sustainable development and, thus, economic growth, whilst safeguarding the primary function and purpose of the strategic road network.'

2.2.1.2 National Highways is responsible for operating, maintaining and improving the Strategic Road Network (SRN) in England.

2.2.1.3 DfT Circular 02/2013 is guided by the Government's core objective of providing 'safe roads, reliable journeys, informed travellers'. It expects initiatives to be put forward to manage the traffic impact of a proposed development and support the promotion of sustainable transport, which would be expected to include a robust travel plan.

2.2.1.4 DfT Circular 02/2013 confirms that a project is likely to be acceptable if it 'can be accommodated within the existing capacity of the strategic road network...or does not increase demand for use of a section that is already operating at over-capacity levels, taking account of any travel plan, traffic management and/or capacity enhancement measures that may be agreed.'

2.2.1.5 DfT Circular 02/2013 also states that all environmental implications associated with a proposed development should be adequately assessed in accordance with prevailing policies and standards. This requirement applies to the environmental impacts arising from the temporary construction works as well as the permanent/operational situation.

2.2.2 *Overarching National Policy Statement for Energy EN-1 (DECC 2011)*

2.2.2.1 The National Policy Statement (NPS) for Energy (EN-1) sets out national policy for energy infrastructure in relation to Nationally Significant Infrastructure Projects (NSIPs).

2.2.2.2 This NPS notes in Section 5 that:

'The transport of materials, goods and personnel to and from a development during all project phases can have a variety of impacts on the surrounding transport infrastructure and potentially on connecting transport networks, for example through increased congestion. Impacts may include economic, social and environmental effects. Environmental impacts may result particularly from increases in noise and emissions from road transport. Disturbance caused by traffic and abnormal loads generated during the construction phase will depend on the scale and type of the proposal.'

The consideration and mitigation of transport impacts is an essential part of Government's wider policy objectives for sustainable development as set out in Section 2.2 of this NPS.

If a project is likely to have significant transport implications, the applicant's ES (see Section 42) should include a transport assessment, using the NATA/WebTAG methodology stipulated in Department for Transport guidance, or any successor to such methodology. Applicants should consult National Highways and Highways Authorities as appropriate on the assessment and mitigation.

Where appropriate, the applicant should prepare a travel plan including demand management measures to mitigate transport impacts. The applicant should also provide details of proposed measures to improve access by public transport, walking and cycling, to reduce the need for parking associated with the proposal and to mitigate transport impacts.

Where mitigation is needed, possible demand management measures must be considered and if feasible and operationally reasonable, required, before considering requirements for the provision of new inland transport infrastructure to deal with remaining transport impacts.

The Infrastructure Planning Commission (IPC) should have regard to the cost-effectiveness of demand management measures compared to new transport infrastructure, as well as the aim to secure more sustainable patterns of transport development when considering mitigation measures.

Water-borne or rail transport is preferred over road transport at all stages of the project, where cost-effective.'

2.2.2.3 A draft revision of this NPS was issued for consultation in September 2021 with the consultation period ending in November 2021. The guidance set out above from the current 2011 NPS remains valid.

2.2.3 NPS for Renewable Energy Infrastructure EN-3 (DECC 2011)

2.2.3.1 NPS EN-3, together with NPS EN-1, provides the primary guidance for nationally significant renewable energy infrastructure.

2.2.3.2 NPS EN-3 notes in Section 2.5 that:

‘Biomass or EfW (Energy from Waste) generating stations are likely to generate considerable transport movements. For example, a biomass or EfW plant that uses 500,000 tonnes of fuel per annum might require a large number of heavy goods vehicle (HGV) movements per day to import the fuel. There will also be residues which will need to be regularly transported off site.

Government policy encourages multi-modal transport, and the IPC should expect materials (fuel and residues) to be transported by water or rail routes where possible.

Applicants should locate new biomass or waste combustion generating stations in the vicinity of existing transport routes wherever possible. Although there may in some instances be environmental advantages to rail or water transport, whether such methods are viable is likely to be determined by the economics of the scheme. Road transport may be required to connect the site to the rail network, waterway or port. Therefore, any application should incorporate suitable access leading off from the main highway network. If the existing access is inadequate and the applicant has proposed new infrastructure, the IPC will need to be satisfied that the impacts of the new infrastructure are acceptable.’

2.2.3.3 A draft revision of this NPS was issued for consultation in September 2021 with the consultation period ending in November 2021. The guidance set out above from the current 2011 NPS remains valid.

2.2.4 National Planning Policy Framework (MHCLG, 2021)

2.2.4.1 The National Planning Policy Framework (NPPF) revised by Ministry of Housing, Communities & Local Government (MHCLG) in July 2021 sets out the government’s planning policies for England and how these are expected to be applied.

2.2.4.2 The NPPF is a relevant consideration in decisions on NSIPs, although in cases of any inconsistency, the NPS takes precedence.

2.2.4.3 Section 9 of the NPPF (Paras. 104 to 113) sets out the approach for promoting sustainable transport. It requires that all development generating significant amounts of movement should be supported by a Transport Assessment (TA) so that the impacts of the proposal on the transport network and environment can be adequately assessed (Para. 113). It also suggests that transport should be considered at the earliest stages of development proposals (Para. 104) so that inter alia:

- opportunities to promote walking, cycling and public transport use are identified and pursued; and
- patterns of movement, streets, parking and other transport considerations are integral to the design of schemes and contribute to making high quality places.’

2.2.4.4 When considering development proposals, the NPPF recommends that applications ensure that:

- “appropriate opportunities to promote sustainable transport modes can be – or have been – taken up, given the type of development and its location;
- safe and suitable access to the Site can be achieved for all users; and
- any significant impacts from the development on the transport network (in term of capacity and congestion), or on highway safety, can be cost effectively mitigated to an acceptable degree.”

2.2.4.5 Paragraph 111 states that development ‘should only be prevented or refused on highways grounds if there would be an unacceptable impact on highway safety, or the residual cumulative impacts on the road network or road safety would be severe.’

2.2.4.6 Paragraph 112 states that development applications should:

- “give priority first to pedestrian and cycle movements, both within the scheme and with neighbouring areas; and second – so far as possible – to facilitating access to high quality public transport, with layouts that maximise the catchment area for bus or other public transport services, and appropriate facilities that encourage public transport use;
- address the needs of people with disabilities and reduced mobility in relation to all modes of transport;
- create places that are safe, secure and attractive – which minimise the scope for conflicts between pedestrians, cyclists and vehicles, avoid unnecessary street clutter, and respond to local character and design standards;
- allow for the efficient delivery of goods, and access by service and emergency vehicles; and
- be designed to enable charging of plug-in and other ultra-low emission vehicles in safe, accessible and convenient locations.”

2.3 Local Policy

2.3.1 North Lincolnshire Local Plan (2003) Saved Policies (2007)

2.3.1.1 The Project is located within the administrative district of North Lincolnshire Council (NLC), which is a unitary authority.

2.3.1.2 Much of the North Lincolnshire Local Plan (adopted in May 2003) has been replaced by the Local Development Framework (discussed later in this section) although some policies from this Local Plan have been saved including the key transport-related policies summarised below:

- T1 Location of Development: Development will be encouraged to locate in principal settlements where they “are easily accessible by foot, cycle and public transport” and where development involves significant movement of freight this should be located where “good access is possible to rail, water and the North Lincolnshire Strategic Road Network.”

- **T2 Access to Development:** It is important that all development is accessible both for all modes of transport and by all users irrespective of any mobility impairment. “It must be served adequately by public transport, cycling, walking and the existing highway network.”
- **T6 Pedestrian Routes and Footpaths:** Major new developments will be required to include links to nearby existing or proposed pedestrian routes.
- **T7 Development of a Cycle Network:** To promote cycling as a mode of transport.
- **T8 Cyclists and Development:** New developments will be required to: i) include cycle links with existing or proposed routes where such opportunity exists; and ii) ensure that the provision of cycle parking facilities are in accordance with the standards set out in Appendix 2.
- **T9 Promoting Buses and Trains:** The use of buses and trains will be encouraged as an alternative to the private car.
- **T11 Protecting Rail Routes:** The existing network of rail freight / disused railway alignments will be protected from development where there is a reasonable prospect of their re-use for transport purposes.”
- **T14 The North Lincolnshire Strategic Road Network (NLSRN):** Traffic should be channelled onto the roads in the North Lincolnshire area, which are most able to accommodate it. Inter urban traffic in this area is predominantly routed via the M180/M181.
- **T15 Highway Improvements and New Highway Construction:** Where new highway infrastructure is being developed, a balance must be struck between restricting environmental impacts associated with construction and operation and the overall community benefits of the scheme.
- **T19 Car Parking Provisions & Standards:** Car Parking provision should comply with the Parking Provision Guidelines set out in Appendix 2 of the Local Plan.
- The Parking Provision Guidelines set out North Lincolnshire’s car and cycle parking standards for new developments based on their land use classification. Given that the Project does not fall within a specific land use classification and is considered ‘sui generis’, an appropriate level of car parking has been provided based on the bespoke operations at the Project.
- **T22 Rail Freight:** The use of rail for goods traffic will be encouraged.
- **T23 Water Freight:** Water transport represents an efficient means of moving a variety of freight cargoes. There is scope for industry to capitalise on these facilities
- Proposals for new water freight development will be required to demonstrate that the movement of heavy goods by road is minimised by making use of deep-water frontages in the following ways:
 - locating on deep-water frontages; and
 - ensuring transfer of bulk goods from sea to inland makes optimum use of railways, rivers, canal and pipelines/ conveyor belts where appropriate.
- **T24 Road Freight:** North Lincolnshire Council will promote alternative means of freight movement to HGVs. Where transporting freight by road is the only

feasible option the Council will seek to develop measures to mitigate the adverse impact of these vehicles where necessary.

2.3.2 North Lincolnshire Local Development Framework – Core Strategy (2011)

2.3.2.1 This Core Strategy sets out NLC’s long-term spatial planning framework for the development of North Lincolnshire up to 2026.

2.3.2.2 NLC’s vision is to become the Global Gateway for the north of England. Whilst it is NLC’s ambition to grow North Lincolnshire, the main priority is to ensure that all developments are sustainable and complement and enhance the area’s high quality natural and built environment without any detrimental impact.

2.3.2.3 It also highlights North Lincolnshire’s great potential to support the continued growth of renewable energy industries.

2.3.2.4 Chapter 12 on Sustainable Waste Management notes that “all activities generate waste, which needs to be collected, managed and disposed of in a suitable way.”

2.3.2.5 Chapter 15 on Transport & Communications notes that “rail is becoming increasingly important in the movement of freight due to the need to use more sustainable modes for freight transport.” Policy CS25 states that “The council will support and promote a sustainable transport system in North Lincolnshire that offers a choice of transport modes and reduces the need to travel through spatial planning and design and by utilising a range of demand and network management tools [including] the development of a freight strategy... to include... provision of facilities for (and promote the benefits of) transferring freight delivery from road to rail and/or water transport, wherever practical, particularly in relation to the movement of freight to and from the South Humber Ports and Trent Wharves.”

2.3.3 Emerging North Lincolnshire Local Plan (2022 / 2023)

2.3.3.1 NLC is preparing a new Local Plan for North Lincolnshire to provide guidance for development to 2036. This new Local Plan is intended to replace the saved policies from the adopted Local Plan and the Local Development Framework. The draft new Local Plan is due to be published later this year / early 2023.

2.3.3.2 The emerging Local Plan recognises that development management provides an opportunity to seek to modify travel demands and habits to promote sustainable development.

2.3.3.3 It states that the level of transport assessment required should be discussed and agreed upon with NLC prior to submitting a planning application.

2.3.3.4 In terms of a Travel Plan, it states that the measures for each site will vary depending upon the circumstances of each development, the requirements

and travel patterns of the site users and the constraints and opportunities offered by the site itself. Particular measures to be considered are discussed in more detail in the Travel Plan submitted with the planning application.

2.3.3.5 In terms of freight movement, the efficient movement of freight is of significant importance in North Lincolnshire. It states that the development of a freight transport strategy should include “HGV route management and provision of facilities for (and promote the benefits of) transferring freight delivery from road to rail and/or water transport, wherever practical, particularly in relation to the movement of freight to and from the South Humber Ports and Trent Wharves.”

2.4 Guidance

2.4.1 *IEMA Guidelines for the Environmental Assessment of Road Traffic*

2.4.1.1 The IEMA Guidelines for the Environmental Assessment of Road Traffic were published in 1993. The guidelines are still current and set out an assessment methodology to identify likely effects, which could be considered as potentially significant, and the approach to informing of how changes in travel demand (particularly traffic) will affect the environment.

2.4.1.2 These guidelines identify requirements to consider the effects on pedestrians, cyclists and other road users, including amenity, delays and severance. They also require an assessment of effects on drivers and ultimately, road safety.

2.4.2 *Port Marine Safety Code, DfT/MCA Nov 2016*

2.4.2.1 The Port Marine Safety Code sets out a national standard for every aspect of port marine safety. Its aim is to enhance safety for everyone who uses or works in the UK port marine environment.

2.4.3 *A Guide to Good Practice on Port Marine Operations, DfT/MCA Feb 2018*

2.4.3.1 This Guide has been developed by representatives from industry, the DfT, and the Maritime & Coastguard Agency (MCA).

2.4.3.2 It is intended to supplement the Port Marine Safety Code and contains more detailed guidance on a number of issues relevant to the management of ports and other marine facilities.

3. CONSULTATION

3.1.1.1 Table 1 below presents an excerpt from the scoping response received from the Planning Inspectorate specific to Traffic and Transport. The table describes how each response has been or will be addressed by the Project. This scoping response incorporates the points raised separately by CH2M (Consultants for National Highways), which have been fully addressed.

Table 1: Scoping Consultation Responses

PINS ID	Issue	Inspectorate's comments	Response / Action	Reference within this document
4.9.1	Proposed to be scoped out of the EIA: Hazardous and Abnormal Indivisible Loads (AIL) effect on the road network	Insufficient information has been provided regarding the Proposed Development construction process including the transport of AIL for this matter to be scoped out of the ES. The Transport Assessment (TA) which is proposed to be appended to the ES should describe the anticipated number of hazardous loads and AIL associated with the Proposed Development and the relevant legislation which applies to such. The ES should include an assessment of the effect on the road network from hazardous and AILs where significant effects are likely to occur. The Applicant should make effort to agree on the approach to the assessment with relevant consultation bodies.	An outline Construction Logistics Plan (CLP) is being submitted with the DCO application, which sets out the logistics activity and management during the construction phase including measures to mitigate any impact. AILs are anticipated by road but the details of this are currently unknown. Once a contractor has been appointed a detailed assessment would be undertaken and appropriate legislation would be followed, including discussions with the relevant authorities at the appropriate time.	Sections 4 and 8
4.9.2	Strategic Road Network	The ES should assess impacts to the Strategic Road Network (SRN), including the M180 and M181, where significant effects could occur.	Impacts on the SRN have been included in the assessment, which concludes that no significant impacts/effects occur.	Section 8
4.9.3	Traffic modelling	Limited information has been provided on the traffic modelling to be undertaken. The ES should describe the numbers and types of traffic movements associated with the construction and	The anticipated Trip Generation during operation and construction (including vehicle routing) has been described in this Traffic and Transport Chapter together with any assumptions made.	Sections 4 and 8

PINS ID	Issue	Inspectorate's comments	Response / Action	Reference within this document
		operation of the Proposed Development and set out and justify the assumptions made in calculating trip generation. The ES should also provide information regarding the anticipated transport routes which will be used to transport materials to and from the Proposed Development during construction and operation. The ES should explain if road closures will be required during construction phase and assess the impacts where significant effects are likely to occur.	There are no road closures anticipated during the construction phase.	
4.9.4 and 4.9.5	Scope of the assessment	The Inspectorate notes that further discussions with the relevant highway authorities are proposed to confirm the scope of the traffic and transport assessment. The ES and accompanying appendices should clearly document any consultations undertaken with regards to the scope of the proposed assessment, including particular matters agreed/ not agreed. Where the scope differs from that requested by the relevant highway authority, the ES should provide justification for the alternative approach.	The scope of the Transport Assessment has been discussed and agreed in principle with the highway authorities (NLC and National Highways).	Section 5
4.9.6	Traffic monitoring	The Scoping Report states that traffic counts at junctions and highway links throughout the study area were commissioned in October 2020. The Inspectorate notes that COVID-19 disruption has potential to impact upon the traffic counts commissioned in October 2020, and as such, justification will need to be provided as to why these counts are valid for use within the TA.	Suitable adjustment factors have been agreed with NLC/National Highways to take account of the COVID-19 travel disruption.	Section 5
4.9.7	Shipping and navigation	The Traffic and Transport chapter of the ES should include an assessment of impacts resulting from transportation of materials/abnormal loads to the site via water, if	Operational freight transport by river has been explored in the Navigational Risk Assessment (NRA) (Document Reference 6.3.6) and is summarised in this Traffic and Transport Chapter.	Sections 4 and 8

PINS ID	Issue	Inspectorate's comments	Response / Action	Reference within this document
		<p>this option is pursued. This should include an assessment of any impacts to navigation which are likely to result in significant effects. Impacts from the Proposed Development alone and cumulatively with other developments should be considered. The assessment methodology and any necessary mitigation measures should be discussed and agreed upon with the relevant consultation bodies.</p>	<p>The impact of any additional river freight associated with the Project is not shown to have a significant impact on navigation in the River Trent and can be adequately accommodated at Flixborough Wharf.</p> <p>There were no committed developments shown to include river transport modes. Therefore, a cumulative assessment is not required.</p> <p>The use of river modes during construction is being explored further as the scheme develops. In terms of AILs, these are not anticipated to come via water as part of the construction phase, but this will be reviewed in more detail once the precise nature of AILs becomes known.</p>	
4.9.8	Study Area	<p>The ES should state the study area used for the traffic and transport assessment and ensure the extent of the study area extends to cover all potential significant effects, and a figure(s) of the study area should be provided within the ES. The Applicant should make effort to agree on the assessment study area with the relevant consultation bodies.</p>	<p>The transport assessment study area has been discussed and agreed in principle with the highway authorities (NLC and National Highways).</p>	Section 5
4.9.9	Cross-referencing	<p>Impacts from transport and traffic overlap with impacts from other aspects such as air quality, noise, and ecology. It should be clear within the ES how the outcomes of the traffic modelling have informed other relevant assessments and appropriate cross-referencing should be between relevant aspect chapters. The ES should explain the nature of the interaction and where potential impacts have been assessed.</p>	<p>Reference has been made to this in this Chapter.</p>	Sections 5 and 8

3.1.1.2 Table 2 below sets out the key stakeholder comments from the pre-application statutory consultation specific to Traffic and Transport. The table describes how each response has been or will be addressed by the Project. Responses have been included when they are directly relevant to the Infrastructure Planning (Environmental Impact Assessment) Regulations 2017 (the Infrastructure EIA Regulations 2017), have required a technical clarification and / or further impact assessment. The full set of responses is contained in the Consultation Report (**Document Reference: 7.1 Appendix I-1**).

3.1.1.3 The consultee types for the purposes of statutory consultation under the 2008 Act are as follows:

- s42(a) is with prescribed consultees;
- s42(b) is with local authorities;
- s44 is with consultees with an interest in land; and
- s47 is with the local community.

Table 2: Section 42 and Section 47 Consultation Responses on the PEIR

Consultee Type	Consultee	Comment	Response / Action	Reference within this document
S42(a)	Canal & River Trust	As advised on our response to the scoping consultation in November 2020, the application site is located to the east of the River Trent and includes proposals to expand wharf facilities at Flixborough on the river. The Canal & River Trust is Navigation Authority for the Stainforth & Keadby Canal and for the River Trent upstream of Gainsborough. Our interest in this proposal is therefore to ensure that there are no adverse impacts on navigational safety upon our network. Whilst we are not Navigation Authority or Harbour Authority for the stretch of waterspace alongside Flixborough; changes to waterbourne transport to and from site could have indirect impacts upon the	The point is noted. The extent of the marine operations has been identified in the preliminary Navigational Risk Assessment (NRA), which is summarised in of Chapter 13: Traffic and Transport of the Environmental Statement (Document Reference 6.2.13), along with the defined project site boundaries. The use of the Inland Waterway Network is not envisaged, and the impact of river traffic is only expected to occur between Flixborough and the Humber Estuary. No adverse impact on navigational safety within the Canal & River Trust network is anticipated.	Paragraph 6.1.5.6, Section 8.2.5

Consultee Type	Consultee	Comment	Response / Action	Reference within this document
		<p>use of our network, should the wharf be designed to accommodate inland traffic.</p> <p>Due to the relationship with the Humber Estuary, we anticipate that future boat movements at Flixborough will likely be to and from the north, with limited use of our network. However, this is not fully confirmed within the Traffic and Transport Chapter of the submitted PEIR. We advise that confirmation should be given alongside the future submission as to whether the use of the Inland Waterway Network is envisaged as part of the scheme, either pre or post development. Should the proposals seek to utilise the Inland Waterway Network, then we respectfully request that the application should provide information upon the predicted boat movements on our network, so that we can advise whether the predicted traffic levels can be accommodated on our network.</p>		
S42(a)	Flixborough Parish Council	The Parish Council are keen to increase sustainable transport in the Parish and welcome the plans to create new pedestrian and cycle routes.	One of the Project Principles is to “maximise sustainable methods and approaches” and this applies to transport. Flixborough Parish Council’s support for the proposed new pedestrian and cycle routes is welcomed.	N / A
S42(a)	Maritime and Coastguard Agency	The MCA has previously advised that a Navigation Risk Assessment (NRA) should be undertaken for this project which considers the impact of the works on shipping and navigation, and the ongoing safe operation of the site after construction. It is our understanding that ABP Humber is the port authority responsible for safe navigation at the existing port facility at Flixborough. As far as we can see the Navigation Risk Assessment itself has not been submitted as part of the PEIR	<p>A preliminary NRA was issued as Annex 7 of the Preliminary Environmental Information Report and is summarised in Chapter 13: Traffic and Transport of the Environmental Statement (Document Reference 6.2.13). This is considered appropriate for this stage in the DCO process.</p> <p>If there are further requirements for using the river, additional NRAs could be required. This</p>	Paragraph 6.1.5.6, Section 8.2.5

Consultee Type	Consultee	Comment	Response / Action	Reference within this document
		<p>submission, although there are aspects considered throughout Chapter 13 Traffic and Transport. We note that section 4.9.1.11 of the PEIR Non-Technical Summary states ‘the use of the river modes to transport to transport freight during operation has been explored. Based on a NRA the anticipated increase of vessel movements could be adequately accommodated at Flixborough and its effects on navigation safety on the River Trent would not be significant’. In section 4.9.2.2. it further states that ‘this assessment will be reviewed at the ES stage as the project design evolves ad the overall results of this assessment will be presented in the ES’. The MCA would expect the NRA to be included in the ES, and the impact on shipping and navigation on the River Trent to be fully assessed in consultation with ABP Humber. Statutory consultees should be satisfied the statement that ‘the effects on navigation safety on the River Trent would not be significant’, is fully justified and supported through the NRA.</p>	<p>would be considered as part of the detailed designs following submission of the DCO.</p>	
S42(a)	Maritime and Coastguard Agency	<p>As the site falls within the jurisdiction of ABP Humber, we would expect consideration to be given to the current powers held by ABP Humber under the Harbours Act 1964 to cover any changes to the current port operations (i.e. Harbour Revision Order if necessary). To address the ongoing safe operation of the marine interface for this project, we would point the developers in the direction of the Port Marine Safety Code (PMSC) and its Guide to Good Practice. They will need to liaise and consult with ABP Humber as the Statutory Harbour Authority and develop a robust</p>	<p>This is noted. The marine consultants to the Project are in correspondence with ABP Humber.</p>	N / A

Consultee Type	Consultee	Comment	Response / Action	Reference within this document
		Safety Management System (SMS) for the project under this code.		
S42(a)	Network Rail	<p>Network Rail has been reviewing the information to date and at this stage it is not sufficiently detailed to fully assess potential impacts of the scheme on the railway and further information will be required to properly respond on the likely impacts of the proposed scheme. Initial points of concern include (but are not necessarily limited to) the reinstatement of 6km of rail track between the power station site and Dragonby Sidings to the east, and also proposals for the M181 corridor over the railway to the south of the site which we note is included in the red line boundary for the scheme and it is not clear what development is proposed in this area.</p> <p>In respect of the former, we require clarity from the developer regarding what is being proposed. It is unclear if the area proposed at the Dragonby Sidings end of the disused line incorporates Network Rail's line that runs up to Roxby Gullet land fill which should not be included in the proposals. There are considerations relating to the reinstatement and operation of the disused line in respect of who will own, maintain and operate it and also we would require details on the expected amount of freight traffic. Consideration would need to be given to the impact of rail traffic associated with the site (including frequency, size and tonnage of trains) and its impact on existing services in the adjacent operational railway environment. Much of the infrastructure of the old line has been removed, however, it does include</p>	<p>The Applicant first engaged with Network Rail in September 2020 to request a scheme sponsor and progression of the scheme proposals through Network Rail's project governance (previously known as GRIP and since replaced by PACE). Due to resourcing issues, Network Rail were unable to provide a formal sponsor for the project; therefore, a proxy sponsor was agreed with the Eastern Region Sponsorship team, who would provide the single point of contact. The parties have since entered into a Basic Services Agreement to formalise the engagement process with a Commercial Sponsor provided by Network Rail as the single point of contact going forward.</p> <p>Information has been provided to this contact, setting out the proposed rail services and key areas of focus for engagement with Network Rail, namely:</p> <ul style="list-style-type: none"> a) The status of the Roxby Gullett branch line and connection to Dragonby Rail Sidings (Dragonby Sidings) via Normanby Park Ground Frame; b) Capacity analysis which identified the theoretical available capacity for a standard weekday 24-hour window to and from Normanby Park Ground Frame for Class 4/6 2000t intermodal freight trains. The geographic scope of study extended to recess points at Doncaster, Milford Sidings, Tees Yard and Tyne Yard. The capacity analysis has been completed and reviewed by Network Rail, as set 	Paragraph 4.2.3.5

Consultee Type	Consultee	Comment	Response / Action	Reference within this document
		<p>level crossings and bridges, the status of which is unknown and would have to be considered.</p> <p>In addition to the above, we need further information in order to understand the potential impact that the construction of the proposed scheme could have on operational railway safety. In particular, if construction haulage routes involve deliveries by rail and if road-based haulage routes include passage over operational railway infrastructure such as bridges and level crossings.</p> <p>In respect of these proposals, the developer must fully engage with Network Rail in order to discuss these points and will be required to enter into any necessary licences and agreements required in relation to this scheme.</p>	<p>out in the Rail Operations Report (ROR) in Chapter 13: Traffic and Transport of the Environmental Statement (Document Reference 6.2.13).</p> <p>c) Achieving suitable protection of Network Rail assets for any works associated with construction of district heating / power networks in the local area where these may be undertaken in proximity to / over / under Network Rail assets.</p> <p>Additional discussions were held in the interim with the relevant contacts at Network Rail.</p> <p>The proposed works on the M181 corridor over Network Rail's infrastructure would provide a new district heating connection to be established, subject to agreement with Network Rail on achieving suitable protective provisions.</p> <p>Please refer to the Rail Operations Report (ROR) summarised in Chapter 13: Traffic and Transport of the Environmental Statement (Document Reference 6.2.13) for further details.</p>	
S42(a)	Network Rail	<p>Network Rail reserve the right to produce additional and further grounds of concern when further details of the application and its effect on Network Rail's land are available.</p> <p>Network Rail will be seeking protection from the exercise of compulsory purchase powers over operational land either for permanent or temporary purposes. In addition, Network Rail will wish to agree protection for the railway during the course of the construction works and otherwise to protect our undertaking and land interests. Network Rail</p>	<p>The Project and the Order Limits encompass all physical trackworks required within Dragonby Sidings and the Flixborough Branch Line, to allow the track layout needed to accommodate the proposed rail services to be provided.</p> <p>Please refer to the Rail Operations Report (ROR) in this Chapter 13: Traffic and Transport of the Environmental Statement (Document Reference 6.2.13) for further details.</p> <p>The Project will not require any physical trackworks on Network Rail infrastructure.</p>	Paragraph 4.2.3.5

Consultee Type	Consultee	Comment	Response / Action	Reference within this document
		<p>reserves the right to produce additional and further grounds of concern when further details of the application and its effect on Network Rail's land are available. In addition, any rights for power or other lines under, over or alongside the railway line will require appropriate asset protection measures deemed necessary by Network Rail to protect the operational railway and stations. We have standard protective provisions which will need to be included in the DCO as a minimum therefore contact should be made to [personal details redacted] to obtain a copy of the relevant wording. In addition a number of legal and commercial agreements will need to be entered into, for example, asset protection agreements, method statements, connection agreements, property agreements and all other relevant legal and commercial agreements. This list is not exhaustive and will need to be reviewed once more details of the scheme are discussed between the parties. Consideration should be given to ensure that the construction and subsequent maintenance can be carried out without adversely affecting the safety of, or encroaching upon Network Rail's adjacent land. In addition, security of the railway boundary will require to be maintained at all times. In any event you must contact Network Rail's Asset Protection Engineers as soon as possible in relation to this scheme on the following e-mail address AssetProtectionEastern@networkrail.co.uk Network Rail is prepared to discuss the inclusion of Network Rail land or rights over land subject to there being no impact on the operational railway,</p>	<p>Network Rail has proposed possible enhancements to its own signalling systems to facilitate an increased quantum of train movements from Roxby Gullett, Vossloh Cogifer at Dragonby Sidings and NLGEP. Any works undertaken by Network Rail on its own signalling by agreement with the parties would fall outside of the NLGEP Order Limits.</p> <p>The reinstatement of the 6km of rail track on the Flixborough Branch Line (most of which remains in situ) would be undertaken on land entirely within the control of the Project as a private railway, requiring no direct infrastructure or operational interface with Network Rail. The status and/or treatment of any crossings and bridges on the Flixborough Branch Line are therefore outside of Network Rail's responsibility. Trains operated to and from the Project would connect to the intermediate Dragonby Sidings which are similarly in private ownership with Vossloh Cogifer, from where trains would then interface with Network Rail at Normanby Park Ground Frame. The Applicant would enter into a Facilities Access Agreement with Vossloh, which in turn has a Connection Contract with Network Rail.</p> <p>The Applicant has wished to understand the interaction between trains to and from site and the capabilities of the wider national rail network, and by agreement with Network Rail has undertaken a Capacity Study using a remit and contractor shortlist approved by Network Rail's Capacity Planning team. The report</p>	

Consultee Type	Consultee	Comment	Response / Action	Reference within this document
		<p>all regulatory and other required consents being in place and appropriate commercial and other terms having been agreed between the parties and approved by Network Rail's board.</p> <p>Network Rail also reserves the right to make additional comments once we have evaluated the proposals in more detail. Network Rail would be grateful if the comments and points detailed within this consultation response are considered by North Lincolnshire Green Energy Park Ltd.</p> <p>Network Rail would welcome further discussion and negotiation with North Lincolnshire Green Energy Park Ltd in relation to the proposed development.</p> <p>If you have any questions or require more information in relation to the above please let me know.</p>	<p>findings have been reviewed by the Capacity Planning team.</p> <p>The Project will not require haulage routes to be constructed over Network Rail infrastructure, nor would it require any changes to bridges or level crossings over Network Rail infrastructure.</p> <p>The Applicant engaged with Network Rail at an early stage of the project to discuss licences, agreements and protective provisions, and look forward to further dialogue as soon as Network Rail resources allow.</p> <p>The Applicant will liaise with Network Rail on these matters through the appropriate contacts. Comments regarding the inclusion of Network Rail land or rights over land are noted, as are those regarding Network Rail's right to make additional comments once the proposals have been evaluated further.</p> <p>We would welcome further discussions based on your comments and our responses above, into which we can involve other Network Rail colleagues as appropriate.</p>	
S42(a)	Network Rail	<p>In respect of these proposals, the developer must fully engage with Network Rail in order to discuss these points and will be required to enter into any necessary licences and agreements required in relation to this scheme.</p>	<p>This is noted. At the time of writing, the intention is that the details and status of the various licences, agreements and protective provisions will be set out in the Statement of Common Ground. The Applicant will liaise with Network Rail on these matters through the appropriate contacts.</p>	N / A
S42(b)	North Lincolnshire Council	<p>The Council's Highways officers have reviewed chapter 13 of the PEIR and have further confirmed that they have had detailed pre-application discussions with the developer regarding the</p>	<p>This is noted.</p> <p>Indeed, conversations have been ongoing with North Lincolnshire Council's Highways Department regarding the construction of the</p>	N / A

Consultee Type	Consultee	Comment	Response / Action	Reference within this document
		<p>proposals and the level of supporting information that needs to be provided. This has included discussions around the proposals for the new road and the installation of district heating pipes, traffic management requirements etc and how this can/will be managed. As far as I am aware these discussions are still ongoing and will inform the final ES.</p>	<p>DHPWN and the mitigation required. As set out in Chapter 13: Traffic and Transport of the Environmental Statement (Document Reference 6.2.13) where the DHPWN impacts the highway network, a single lane will be closed (except for traversing roundabouts where the road will be closed in sections or worked on at night with road plates ensuring day-time operation), with traffic flow managed by traffic lights. The works plans limit the working width of the DHPWN to a single lane of the highway.</p>	
S42(b)	West Lindsey District Council	<p>West Lindsey's primary consideration would be the impact of the construction, operation and decommissioning phases on the local highway network. Page 20 of the supplementary consultation booklet (summer 2021) provides a summary on traffic and transport but a more detailed assessment is provided in Chapter 13 of the Preliminary Environmental Information Report (PEIR). Chapter 13 of the PEIR does not mention West Lindsey or any of its main highway routes such as the A15 or the A159 through the village of Scotter. West Lindsey would request that its highway network is considered in any future traffic and transport assessments and would recommend that the Highways Authority at Lincolnshire County Council is consulted for comment.</p>	<p>We have assumed that all traffic related to the Project during operation (Heavy Goods Vehicles and employees) will route primarily from the A1077 (north of B1216 Ferry Road West / A1077 junction) and the M180 (either direction). A limited amount of traffic has been estimated to route from / to the A18 Doncaster Road, for example circa 8% for employees and 5% for Heavy Goods Vehicles (HGVs). Furthermore, the percentage impact analysis undertaken on the local highway network shows that a very limited number of trips will route onto the A18 Doncaster Road, equating to less than 1% change in traffic flows on the A18 Doncaster Road. The percentage change on the A15 and A159 would be less than this as traffic dissipates further across the highway network. Transport impact on the West Lindsey District Council (WLDC) network, including the A15 and A159, was therefore considered to be small / negligible and thus detailed junction modelling not considered necessary. This was agreed with NLC as part of the Transport Assessment (TA)</p>	Appendix B

Consultee Type	Consultee	Comment	Response / Action	Reference within this document
			<p>scoping process, which is detailed in Appendix B of Chapter 13: Traffic and Transport of the Environmental Statement (Document Reference 6.2.13). In terms of construction, similarly as above, the increase in construction trips on the WLDC network were shown to be small.</p>	
S44	West Lindsey District Council	<p>West Lindsey's primary consideration would be the impact of the construction, operation and decommissioning phases on the local highway network. Page 20 of the supplementary consultation booklet (summer 2021) provides a summary on traffic and transport but a more detailed assessment is provided in Chapter 13 of the Preliminary Environmental Information Report (PEIR). Chapter 13 of the PEIR does not mention West Lindsey or any of its main highway routes such as the A15 or the A159 through the village of Scotter. West Lindsey would request that its highway network is considered in any future traffic and transport assessments and would recommend that the Highways Authority at Lincolnshire County Council is consulted for comment.</p>	<p>We have assumed that all traffic related to the Project during operation (Heavy Goods Vehicles and employees) will route primarily from the A1077 (north of B1216 Ferry Road West / A1077 junction) and the M180 (either direction). A limited amount of traffic has been estimated to route from / to the A18 Doncaster Road, for example circa 8% for employees and 5% for Heavy Goods Vehicles (HGVs).</p> <p>Furthermore, the percentage impact analysis undertaken on the local highway network shows that a very limited number of trips will route onto the A18 Doncaster Road, equating to less than 1% change in traffic flows on the A18 Doncaster Road. The percentage change on the A15 and A159 would be less than this as traffic dissipates further across the highway network.</p> <p>Transport impact on the West Lindsey District Council (WLDC) network, including the A15 and A159, was therefore considered to be small / negligible and thus detailed junction modelling not considered necessary. This was agreed with NLC as part of the Transport Assessment (TA) scoping process, which is detailed in Appendix B of this chapter. In terms of construction, similarly as above, the increase in construction</p>	Appendix B

Consultee Type	Consultee	Comment	Response / Action	Reference within this document
			trips on the WLDC network were shown to be small.	
S44	#244.8	<p>We note that the proposed DCO boundary encompasses the grass verge/kerb line with several bollards within the #S44.8 site, immediately adjacent to the southern access point (on Second Avenue close to the junction of First Avenue) and manoeuvring apron on the approach to the weighbridge and the staff/visitor car park. However, details of works proposed along First Avenue and Second Avenue are not included in the consultation document.</p> <p>In the absence of details of works at First Avenue and Second Avenue, we would expect that construction of any infrastructure (both during the construction and operational phases) would likely have a detrimental impact on the use of #S44.8's access including space for vehicles to egress and vehicle to vehicle visibility splays.</p> <p>Any relocation of the southern access, as considered in the Transport section of the PEIR, would have an impact on the staff car park, which will change HGV access arrangements and manoeuvring for #S44.8 – whether this can safely be undertaken cannot be assessed as no details of works proposed in and around #S44.8's access have been provided.</p>	<p>The Order Limits are required to include any potential works, signage and utilities required during the construction period.</p> <p>The Applicant held a workshop with #S44.8 on 3 December 2021 and highway works plans were provided to them. It was also agreed that construction and mitigation plans will be shared with #S44.8 for discussion ahead of any works.</p> <p>However, it is worth noting that due to the changes made to the Order Limits since the statutory consultation period, #S44.8's site will not be impacted by the revised layout presented to them.</p>	N / A
S47	Local Community	<p>Rail developments: what will be brought in by rail, where from and how much? What will leave by rail, where to and how much? What will power the traction used, both on the mail line and on site?</p>	<p>We envisage traction to be diesel-electric freight locomotives.</p> <p>RDF will be brought in by train in sealed containers. Aggregate will also be brought in by</p>	N / A

Consultee Type	Consultee	Comment	Response / Action	Reference within this document
			<p>train for use in concrete block manufacture. RDF will be imported daily, while aggregate will be transported to the site using 1 train approximately every 5 days.</p> <p>The outputs designed to be able to leave the site by train include manufactured concrete blocks and captured/compressed CO₂ from the carbon capture utilisation and storage facility (CCUS). The frequency of CO₂ movements would be less than for manufactured concrete blocks.</p> <p>The total number of train movements per day will be consistent with the findings of the rail capacity study, which is based on 3 trains per day each way on the branch line. This could therefore comprise 2 trains per day of RDF and 1 train per day of either CO₂ or concrete blocks, dependant on throughput of the concrete block plant and CCP.</p>	
S47	Local Community	Increased pollution, traffic, heavy vehicles on unsuitable roads the list goes on... the impact will be huge in a negative way	<p>The Transport Assessment, set out in Appendix B of Chapter 13: Traffic and Transport of the Environmental Statement (Document Reference 6.2.13) shows that the increase in traffic is not expected to have a significant impact on the local highway network.</p> <p>It is noted that this assessment was undertaken based on the assumption that 100% freight will arrive / depart by road (HGV), however, it is proposed to also make use of rail and river modes.</p> <p>In terms of air quality, the potential impacts of the HGVs traffic accessing the site was undertaken. The impact at sensitive receptors</p>	Appendix B

Consultee Type	Consultee	Comment	Response / Action	Reference within this document
			was identified to be negligible, and it should be noted that there is a new road planned to access the facility which will bypass the current bottleneck at Neap House.	
S47	Local Community	New cycle routes and footpaths need to be connected to others in the area and not just lead to nowhere, for example make them part of a larger family friendly park/fun area.	The new pedestrian footways and cycle paths connect the site and the surrounding industrial areas with Neap House and the residential areas to the south of the A1077 to encourage walking and cycling to and from the site.	N / A
S47	Local Community	The environmental impacts are clear and will be negative right across the local area and beyond. The mitigations are limited and the excessive traffic that will come through the local village will have a detrimental impact on this small community	There will be no HGV traffic through Flixborough village, due to the existing weight restriction, with all HGVs arriving / departing to and from the south via the A1077. Similarly, employees using cars are expected to access the Project mainly to and from the south, with only a small number (2%) via Flixborough village - equating to around 2 car trips during the peak hour. As set out in Chapter 13: Traffic and Transport of the Environmental Statement (Document Reference 6.2.13) the environmental and transport impact associated with this increase is shown to be negligible.	N / A
S47	Local Community	There is no plan put forward to invest in pedestrianisation of the local village, create safe walking routes or manage the environmental impact. This element feels like a box ticking exercise and offers no detail on where there will be a real investment in education	One of the Design Principles set out in the Design Principles and Codes document (Document Reference 5.12) is to “protect and where possible enhance the amenity of our neighbours”. The new access will mean that there will be no HGV traffic through Flixborough village - restricted due to the existing weight restriction - with all HGVs arriving / departing to and from the south via the A1077. Similarly, employees using cars are expected to access mainly to and from the south, with only a small	N / A

Consultee Type	Consultee	Comment	Response / Action	Reference within this document
			<p>number (2%) via Flixborough village - equating to around 2 car trips during the peak hour. The environmental and transport impact associated with this increase is shown to be negligible.</p> <p>The Project will also enhance the existing public right of way network immediately south of Flixborough and will reinstate a disused footpath crossing and provide a new footpath link south of the railway line connecting FP176 and FP178, subject to discussions with North Lincolnshire Council.</p> <p>Any proposals for pedestrianisation of the village would be outside the limits of this DCO.</p>	
S47	Local Community	Shared cycle lane with pedestrians don't work very well or some of us. Please consider some separation for safety for all	Provision of a shared pedestrian and cycle path facility, with a segregated verge between the carriageway, was agreed in principle with North Lincolnshire Council, as local highway authority, during the pre-application consultation process.	N / A
S47	Local Community	Can we establish exactly what this will be used for? Will this be for inward and outward freight movements and if so, what will be the cargo and approximately how many trains per day will there be? This railway line traverses a public right of way – what steps will be taken to protect this walkway? The intended rail link will have a negative impact on the nearby homes in the village of Flixborough which are less than 20 metres away, and yet your plans are to maximise the number of deliveries by rail. Your documentation also refers to the fact that proposed rail sidings at Dragonby and a rail head to the south of Stather Road will reduce as far as possible the need for rail movements at night. Yet	<p>Rail transport has a crucial role to play in delivering significant reductions in pollution and congestion. Tonne for tonne, rail freight produces 70% less CO₂ than road freight, up to fifteen times lower NOx emissions and nearly 90% lower PM10 emissions. It also has de-congestion benefits – depending on its load, each freight train can remove between 43 and 77 HGVs from the road.</p> <p>In the scenario where rail freight is used to its maximum potential during construction, based on the assumption that a train bringing fill material to Flixborough Wharf would handle an average of 2,000mt, this would represent between 3 and 20 additional train movements at</p>	N / A

Consultee Type	Consultee	Comment	Response / Action	Reference within this document
		clearly any rail movements at night are totally unacceptable.	<p>Flixborough Wharf per month during the construction phase and a maximum total of 50 train movements per year between 2022 and 2026.</p> <p>The assessment for permanent use assumes a 100% provision of freight delivery by rail. However, it may be mixed with delivery from both river and road. In this 100% scenario, assuming 758,376 tonnes per annum of fuel, and a train payload of 1,053 tonnes, this would equate to 720 train arrivals per annum, or 2 trains per day on 360 days per annum or 3 trains per day on 240 days per annum. The timing of trains to and from site would be determined by the Applicant, train operator, Network Rail and the fuel supplier, in order to optimise the transit times between origin(s) and destination, taking advantage of quieter periods on the surrounding national rail network.</p> <p>A public right of way crossing strategy has been developed and public rights of way will be protected as part of the works.</p>	
S47	Local Community	We are a business trading and operating on Flixborough Industrial Estate, an estate that already struggles with the volume of traffic both inbound and outbound. The disruption that this project would cause to this estate and the impact on the businesses trading from here would be huge and potentially damaging	The Transport Assessment in Appendix B of Chapter 13: Traffic and Transport of the Environmental Statement (Document Reference 6.2.13) shows that the increase in traffic is not expected to have a significant impact on the local highway network. It is noted that this assessment was undertaken based on the assumption that 100% freight will arrive / depart by road (HGV). However, in practice, we plan to use the river and reinstated railway line for freight movements once the Project is operational, wherever possible.	Appendix B

Consultee Type	Consultee	Comment	Response / Action	Reference within this document
			Where there is some impact, we will provide mitigation, such as the proposed new access road serving the existing Flixborough Industrial Estate and port area, closing the section of highway on Stather Road between Flixborough Industrial Estate and the existing surface water pumping station north of Neap House, and providing a new pedestrian / cycle footway along the eastern side of the carriageway of the link road.	
S47	Local Community	According to your calculation, the facility will require 15000 tonnes of fuel a week. Thus, this will require a minimum of 341 44t lorries a week, this does not include the traffic for outgoing materials produced at the facility. Will this traffic limited to working hours, and will it be prohibited at weekend and bank holidays?	The Transport Assessment in Appendix B of Chapter 13: Traffic and Transport of the Environmental Statement (Document Reference 6.2.13) was based on the assumption that 100% freight will arrive/depart by road. However, in practice, RDF is planned to be transported to the site via road, rail and river. A Construction Traffic Management Plan will be implemented as part of the Construction Logistics Plan (CLP) - to be agreed with North Lincolnshire Council prior to the construction phase. These documents will include details of working hours, including timings for when vehicles can access the site.	Appendix B
S47	Local Community	Regarding cycle and walking networks will this include restoration and further developing existing road and cycle ways to make them more pedestrian and cycle friendly. There is a landslide blocking the current cycle path through the woods and a temporary path in place that gets waterlogged. The traffic light junction on the orbital road does not recognise a bike so you can wait in	A shared pedestrian and cycle footway will be created along B1216 Ferry Road West, which will be segregated from the carriageway. The new access road will have a pedestrian and cycle route segregated from traffic. The proposed toucan crossing on the A1077 will include a crossing point for both cycles and pedestrians.	N / A

Consultee Type	Consultee	Comment	Response / Action	Reference within this document
		the middle of road very vulnerable on a bike. A pelican would work well to link to the new cycle and walkways		
S47	Local Community	I am concerned that you will interfere with the much-used minor road between Burton upon Stather and Gunness. Your plans are not clear about the future of the stretch that runs close to the river Trent. This route is very popular with local cyclists and those heading from Yorkshire towards the Humber Bridge. Cycle paths are all well and good but quiet roads are needed for longer distance rides. I would hate to lose the road access we currently enjoy.	The section of Stather Road between Flixborough Industrial Estate and the pumphouse (just north of Neap House) will be closed (stopped up), with no access for vehicular traffic. However, it will still be possible for local walkers and cyclists to use this route.	N / A

4. ASSESSMENT PARAMETERS

4.1 Construction Phase

- 4.1.1.1 A month-by-month breakdown of anticipated construction vehicle trips throughout the anticipated construction programme has been provided by North Lincolnshire Green Energy Park Limited (the Applicant) for the Project and this is summarised in Section 8.1.1. This includes detail in relation to construction workers.
- 4.1.1.2 Construction materials are expected to be transported by a combination of road, river and rail. Preliminary investigations have indicated that it may be possible to import some of the fill material via the river during the construction phase but the practicalities of this have yet to be evaluated in detail. The potential for this would be favourable from an environmental perspective as it would replace a large amount of road traffic.
- 4.1.1.3 Rail offers scope to move materials such as construction spoil, aggregates, sand, cement, reinforcement bar and other structural steel. The key dependencies will be the phasing of the works to reinstate the disused branch line from Dragonby Sidings through to the Project, as well as the availability of suitable rail-linked sources of material at sufficient scale and/or distance from Project to make rail viable for transportation. The use of rail during construction will be explored further as the scheme develops.
- 4.1.1.4 The vehicle trip generation set out in this section for the construction phase is based on a worst-case assumption that 100% of freight would arrive/depart by road transport.
- 4.1.1.5 In terms of Hazardous and Abnormal Indivisible Loads (AIL), it is understood that these would be delivered by road during the construction phase with some large items such as the turbines, generators and transformers being brought in by river. A detailed assessment of the plant requirements for AILs has not been undertaken at this stage as this detail is unknown until a contractor has been appointed. Appropriate legislation would be followed, and discussions held with the relevant authorities at the appropriate time.
- 4.1.1.6 For construction materials transported by road, all vehicles are expected to arrive/depart to/from the south via the A1077 / B1216 with the majority via the M181/M180. Construction vehicle movements have been distributed based on observed turning movements across the study area as follows:
- 65% to/from the south via the M180/ M181;
 - 30% to/from the north-east via the A1077 and A15 Humber Bridge; and
 - 5% to/from the east via the A18 / A159.
- 4.1.1.7 In terms of the District Heat and Private Wire Networks (DHPWN), it is anticipated that any equipment installed in the highway, verge or footway may require a single lane closure during the construction phase, but full road closure is unlikely to be required.

4.2 Operational Phase

4.2.1.1 The anticipated year of opening for the Project of 2028 in line with the outline phasing set out in Chapter 3, which anticipates a six-year construction programme, commencing from the grant of DCO (**Document Reference 6.2.3**). 2028 has therefore been taken as the future baseline year for the operational phase assessment.

4.2.1.2 The trip generation associated with the Project has been extracted from the TA and is described later in this section.

4.2.1.3 In terms of future baseline conditions, this has been investigated within the context of cumulative developments and local highway improvement plans in this area. The full list of cumulative schemes is contained in Chapter 18 of this ES (**Document Reference 6.2.18**). An assessment has been undertaken of the trip generation associated with these cumulative schemes, which has shown that there were five schemes considered to be significant in transport terms and these are set out in Table 3 below.

Table 3: Cumulative Schemes included in the Transport Assessment

Name	Planning Application Reference	Type of Development	Forecast Opening Year
Lincolnshire Lakes	PA/2013/1000 (Approval Granted - consent now lapsed) PA/2013/1001 (Approval Granted - consent now lapsed) PA/2017/1386 (Approval Granted) PA/2015/0627 (Approval Granted) PA/2015/0628 (Approval Granted)	Up to 3,000 residential dwellings and other mixed uses – to be built in phases	programme agreed with North Lincolnshire Council: 600 units by 2028 1,800 units by 2033 3,000 units by 2038 Trip Generation included in future baseline assessments
Glanford Park Football Stadium extension	PA/2018/1388; PA/2018/1389; and PA/SCR/2018/10 (Approval Granted)	Stadium extension (employment) and 160 Residential units	Status unknown Assumed to be completed by 2028 - trip generation included in future baseline assessments
Normanby Enterprise Park	PA/2020/1595 (approval granted)	Industrial – change of use	Forecast Opening Year in TA = 2025 Status unknown Assumed to be completed by 2028 - trip generation included in future baseline assessments
Land off Burringham Road, Ashby Parklands, Scunthorpe	PA/2020/1333 – Outline Approval Granted	Residential 144 dwellings	Forecast Opening Year in TA = 2024 Status unknown Assumed to be completed by 2028 - trip generation included in future baseline assessments

Name	Planning Application Reference	Type of Development	Forecast Opening Year
Brumby Resource Centre, East Common Lane	PA/2015/1369 - Outline Approval granted	Residential 122 dwellings	Forecast Opening Year in TA = 2020 Status unknown Assumed to be completed by 2028 - trip generation included in future baseline assessments

4.2.2 Proposed New Access Road and Stopping Up of Stather Road

- 4.2.2.1 In order to facilitate the Project, it is intended to stop up Stather Road between Flixborough Industrial Estate and the existing surface water pumping station situated approximately 160 metres north of Neap House.
- 4.2.2.2 It is intended that any existing traffic currently using this section of Stather Road will relocate to a new proposed access road (New Access Road), which is intended to serve the existing Flixborough Industrial Estate and Port area as well as the Project.
- 4.2.2.3 The alignment of the proposed New Access Road and its associated junctions has been discussed and agreed in principle with NLC.
- 4.2.2.4 It is proposed that the New Access Road will be constructed at the start of the construction phase in 2024 in order for it to be used by construction vehicles during the peak construction period.
- 4.2.2.5 As part of the stopping up proposals, the existing main access for Flixborough Port via Stather Road will be removed. It is proposed to relocate the Port access to First Avenue, which currently serves as the secondary access route to/from the Port. This has been agreed in principle with RMS Trent Ports.
- 4.2.2.6 The redistribution of traffic associated with the proposed stopping up of Stather Road and creation of the proposed New Access Road has been included in the future baseline conditions.

4.2.3 NLGEP Freight Transport

- 4.2.3.1 The Project is an industrial scale facility comprising a number of different elements (as detailed in Chapter 3, **Document Reference 6.2.3**) with access via the proposed New Access Road.
- 4.2.3.2 The Project will generate freight transport movements associated with deliveries of fuel; consumables; concrete block manufacturing materials and the loading of carbon dioxide and collection of concrete blocks from the Project.

- 4.2.3.3 The majority of these freight transport movements will be associated with the Energy Recovery Facility (ERF), which will be located to the west of the proposed New Access Road. Vehicles will enter/exit via the proposed weighbridges where incoming/outgoing fuel will be checked and recorded.
- 4.2.3.4 For the purpose of the TA, a worst-case (robust) assumption has been adopted, which assumes that all freight transport associated with the Project would be transported by road during operation. This approach has been agreed in principle with the local highway authority, NLC, as well as National Highways who are responsible for the strategic highway network (namely, the M180 / M181).
- 4.2.3.5 In reality, it is anticipated that operational freight transport will be split between road, rail and river modes in order to make use of the adjacent River Trent and existing (disused) branch line linking to the national rail network. Options for using these modes have been explored whilst taking account of any practical constraints and commercial factors. This assessment is contained in the Preliminary Navigation Risk Assessment at Annex 6 of the ES (**Document Reference 6.3.6**) and Rail Operations Report (**Document Reference 5.11**). These assessments have been summarised and included within this Traffic and Transport chapter.
- 4.2.3.6 Freight transport movements/deliveries to/from the external highway are expected to take place Monday to Saturday, typically between 06:00 and 20:00 with all vehicles comprising Heavy Goods Vehicles (HGVs), typically articulated HGVs (up to 16.5m in length).
- 4.2.3.7 A summary of typical HGV movements for the Project Monday to Saturday is set out below:
- Total Daily (Average) = 226 HGV arrivals, 226 HGV departures.
 - Total Daily (Peak/Maximum) = 244 HGV arrivals, 244 HGV departures.
 - Total in Peak Hour (1300-1400) = 34 HGV arrivals, 34 HGV departures.
 - AM Highway Peak Hour (0800-0900) = 24 HGV arrivals, 24 HGV departures.
 - PM Highway Peak Hour (1600-1700) = 19 HGV arrivals, 19 HGV departures.
- 4.2.3.8 The peak hour in terms of HGV movements is expected to occur between 13:00 and 14:00 hours, which is noted will not coincide with the highway peak periods on the local highway network.
- 4.2.3.9 All freight transport movements will arrive/depart via the proposed New Access Road to/from the south, via the B1216 and the A1077.
- 4.2.3.10 The existing vehicle weight restriction on Stather Road via Flixborough village will prevent any HGV movements along this route.
- 4.2.3.11 Beyond the A1077, freight transport movements have been distributed as follows:
- 65% to/from the south via the M180/ M181;
 - 30% to/from the north-east via the A1077 and A15 Humber Bridge; and

- 5% to/from the east via the A18 / A159.

4.2.4 NLGEP Employee Trips

4.2.4.1 The total number of employees expected at the Project is shown below in Table 4.

Table 4: NLGEP - Total Employees

	Total Number of Employees
Energy Recovery Facility (ERF)	62
Concrete Block Manufacturing Facility	40
Railhead	10
Plastic Recycling Facility	130
Electric vehicle and hydrogen re-fuelling station	5
Gatehouse and Visitor Centre	10
TOTAL	257

4.2.4.2 Employees are expected to work in shifts with five shifts for operational employees and three shifts for maintenance employees. These shifts typically include a day shift (07:00 to 15:00 or 08:00 to 17:00), a late shift (15:00 to 23:00 or 14:00 to 22:00) and a night shift (23:00 to 07:00). The graph below indicates the number of employees at the Project on a typical working day and shows that the maximum number of employees at the Project at any one time is expected to be 174 between 14:00 and 15:00 hours. There will be a total of 257 employees at the Project, with a maximum of 174 being on the Project at any one time as indicated in Figure 1.

Figure 1: NLGEP – Number of Employees at the Project for typical working day

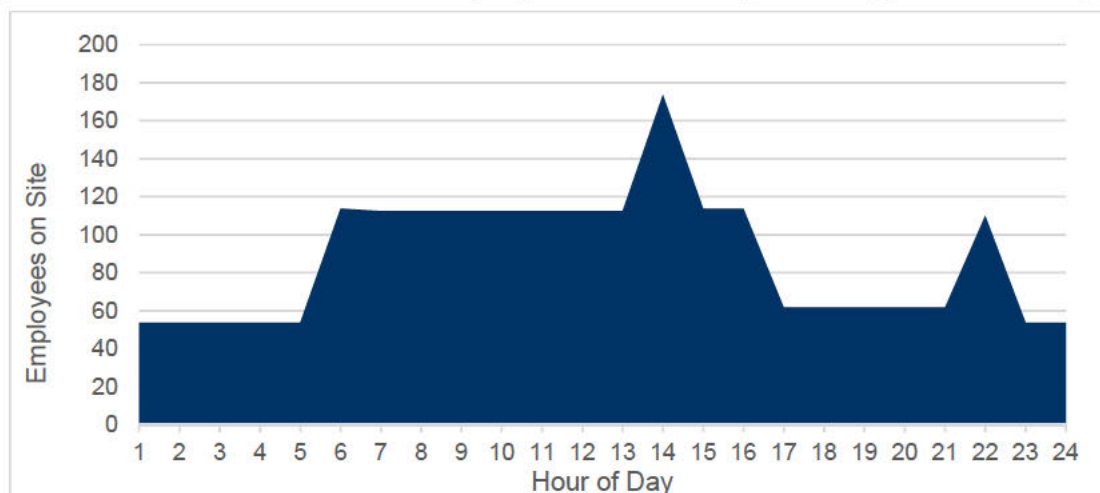

4.2.4.3 The projected mode split of travel by employees at the Project has been extracted from the TA and is set out below in Table 5. This mode split is

considered representative given the nature of the Project and the anticipated shift patterns with some employees working through the night.

Table 5: Mode Split of Travel

Mode of Travel	Percentage Mode Split
Car Driver	76%
Car Passenger	10%
Walk	3%
Cycle	4%
Bus	4%
Motorcycle	1%
Train	2%
Total	100%

4.2.4.4 Table 6 below shows the number of employees anticipated by each travel mode.

Table 6: NLGEP – Employee Trips by Mode

Mode of Travel	Number of Employees
Car Driver	195
Car Passenger	26
Walk	8
Cycle	10
Bus	10
Motorcycle	3
Train	5
Total	257

4.2.4.5 The distribution of employee vehicle trips on the local highway network is described in the TA at Appendix B.

4.2.5 NLGEP Other Vehicle Trips

4.2.5.1 There will also be a very small number of other service vehicle (HGV) trips associated with the Project (such as maintenance vehicles), which have been included in the assessment, together with the trip generation associated with the electric vehicle and hydrogen refuelling station, which is described in more detail in the TA at Appendix B.

4.2.5.2 The proposed 5 No. HGV electric charging bays, 1 hydrogen bus re-fuelling bay and 13 car charging bays are expected to generate 560 vehicles per day (including 140 HGVs and 62 buses).

4.2.6 Total Vehicle Trips

4.2.6.1 A summary of the total vehicle trip generation for the Project is shown below in Table 7.

Table 7: NLGEP – Total Vehicle Trips

Time Period	Total Vehicles	HGVs	Buses
Daily	1,479	707	62
Peak Hour (1400 to 1500)	176	83	0
AM Highway Peak Hour (0800-0900)	58	47	0
PM Highway Peak Hour (1700–1800)	95	54	1

* the number of HGVs/Buses are included in Total Vehicles

4.3 Study Area

4.3.1.1 The methodology for determining the assessment study area is described in Section 5.3.

4.3.1.2 The highway links in the selected study area are shown below in Table 8. The strategic highway network links are highlighted bold with all others forming part of the local highway network.

Table 8: Highway Links included in the Study Area

Highway Link
Bellwin Drive
First Avenue (West of Bellwin Drive)
Stather Rd (West of New Access Rd)
Stather Rd (East of New Access Rd)
First Avenue (East of Bellwin Drive)
New Access Road
Stather Road (West of Neap House)
B1216 Ferry Road West (West of New Access Rd)
A1077 (South of B1216))
A1077 (North of B1216)
Ferry Road West (east of A1077)
Holyrood Drive
Luneburg Way
A1077 (east of Luneberg Way)
A18 Kingsway (West)
A1077 (south of A18)
A18 Doncaster Road (west of A1077)

Highway Link

A159 Ashby Road (south of A18)

A18 Queensway (east of A159)

Ashby Road (north of A18)

A18 Kingsway West (west of A159)

Ferry Road West (east of New Access Road)

M181 (north of M180)

M180 (W)

M181 (E)

5. ASSESSMENT METHODOLOGY AND SIGNIFICANCE CRITERIA

5.1 EIA Scoping

- 5.1.1.1 As outlined in Chapter 4 of the ES (**Document Reference 6.2.4**), EIA scoping was undertaken in 2020 and a summary of the transport-related responses received from the Planning Inspectorate and how these have been addressed are set out in the Consultation section earlier in this Traffic and Transport chapter (Table 1).
- 5.1.1.2 Pre-application statutory consultation has also been undertaken in relation to the PEIR submission in June 2021 and key stakeholder comments specific to Traffic and Transport are set out in the Consultation section earlier in this Traffic and Transport chapter (Table 2). It also sets out how these comments have been addressed in preparation for the application for development consent.
- 5.1.1.3 Furthermore, consultation has also been undertaken directly with NLC and National Highways in relation to the scope of the Transport Assessment (TA).
- 5.1.1.4 The TA and associated transport modelling considers network capacity, while this ES Traffic and Transport chapter considers transport network users' amenity and safety. The scope of both these documents reflects the output of the pre-application consultation process.

5.2 Baseline Study Methodology

- 5.2.1.1 The existing baseline year is 2022, which represents the submission date of the Development Consent Order (DCO) Application.
- 5.2.1.2 The future baseline year for the operational assessment is 2028, which represents the opening year.
- 5.2.1.3 The construction effects of the Project have been assessed for intermediate years 2025 and 2026 as these are expected to be the peak construction year (s) for the Project in terms of construction vehicle movements (described in more detail in Section 0).
- 5.2.1.4 In accordance with the IEMA guidelines, the study area has been defined by identifying any highway link where it is felt that potentially significant environmental effects may occur as a result of the Project. The identified receptors/road users and extent of this study area are detailed later in this Traffic and Transport chapter.
- 5.2.1.5 Existing baseline conditions have been established using the following data:
- Traffic surveys were undertaken between Thursday 15th October and 22nd October 2020 to obtain classified vehicle turning movements and queue observations for all the junctions and adjoining highway links included in the study area. These surveys included 7-day Automatic Traffic Counts (ATCs).

5.2.1.6 Given the travel restrictions imposed by the COVID-19 pandemic situation at the time of these surveys, appropriate factors have been applied to this survey data to ensure that it is representative of typical (pre-COVID) baseline conditions. These factors were agreed with NLC and National Highways as part of the scoping discussions.

- Annual Average Daily/Weekday Traffic (AADT/AAWT) flow data from Department for Transport's (DfT) online database;
- Personal injury collision data obtained from NLC for the latest five-year period to September 2021; and
- Online sources of information and desk-based studies in relation to existing transport conditions on the local highway network, relevant planning policy documents, maps of Public Rights of Way (PRoW) and cycle routes, Ordnance Survey maps, as well as the feedback of the public consultation and responses from stakeholders.

5.2.1.7 In terms of future baseline conditions, this has been investigated within the context of cumulative developments and any transport improvement plans in the local area. The full list of cumulative schemes is contained in Chapter 18 of this ES (**Document Reference 6.2.18**) and an assessment of the trip generation associated with these cumulative schemes has been undertaken as part of the TA and any considered to be significant in transport terms have been included as part of the future baseline assessment.

5.3 Assessment Approach

5.3.1.1 The IEMA guidelines (Section 2: Analysis) identifies groups, locations and areas which may be sensitive to changes in traffic conditions and environmental effects that may be considered to be potentially important when considering traffic from an individual development.

5.3.1.2 It includes a checklist of likely effects covering noise, vibration, visual impact, severance, driver delay, pedestrian delay, pedestrian amenity, fear and intimidation, highway safety, hazardous loads, air pollution, dust and dirt, ecological impact and heritage and conservation areas.

5.3.1.3 Many of these effects are assessed elsewhere within this ES, including Landscape and Visual Amenity (Chapter 11) (**Document Reference 6.2.11**), Noise (Chapter 7) (**Document Reference 6.2.7**), Air Quality (Chapter 5) (**Document Reference 6.2.5**), Ecology and Nature Conservation (Chapter 10) (**Document Reference 6.2.10**) and Archaeology and Cultural Heritage (Chapter 12) (**Document Reference 6.2.12**).

5.3.1.4 The remaining effects that have been assessed in the scope of this Traffic and Transport chapter are defined below:

- potential effects on the community associated with severance caused by an increase in traffic levels during construction and occupation of the Project;
- potential effects on drivers associated with driver delay caused by additional traffic generated by the Project;

- potential effects on pedestrians/cycles associated with delays caused by changes in traffic volume or speed of traffic;
- potential effects on pedestrian/cycle amenity caused by the increase in traffic flow, traffic composition and pavement width/separation from traffic;
- potential effects on pedestrians associated with fear and intimidation caused by an increase in the volume of traffic and its Heavy Goods Vehicle (HGV) composition; and
- potential effects of highway safety caused by the increase in traffic flow as a result of the Project.

5.3.1.5 The potential effects of both construction traffic and operational traffic have been assessed in this Traffic and Transport chapter. It deals only with those transport effects likely to be relevant to the Project:

- severance;
- pedestrian/cycle amenity (which for the purposes of this assessment includes fear and intimidation);
- driver delay;
- pedestrian/cycle delay; and
- highway safety.

5.3.1.6 The potential effects of both construction traffic and operational traffic have been assessed by comparing the likely trip generation of the Project with future baseline traffic conditions in order to determine the percentage increase in traffic on each road that has been taken forward for assessment.

5.3.1.7 The scope of this assessment has been determined based on the IEMA guidelines (Section 3: Traffic Impact Analysis), which indicate that highway links should be included where traffic flows are predicted to:

- Rule 1: increase by more than 30% due to the Project (or the number of heavy goods vehicles will increase by more than 30%); and
- Rule 2: increase by 10% or more on any roads located within specifically sensitive areas.

5.3.1.8 It should be emphasised that these thresholds are relevant only to the assessment of environmental impacts, as higher accuracies (i.e. changes <10%) are within daily variations of traffic on the road and the differences in environmental impact are indiscernible.

5.3.1.9 The TA and associated transport modelling are not based upon these thresholds as it considers network capacity, which follows different industry-standard methodologies with their thresholds not directly comparable to those required for the EIA.

5.4 Assessment of Effects

5.4.1.1 To assist with identifying the magnitude of change as a result of the Project, with regard to traffic and transport, reference has been made to the IEMA

Guidelines (Section 4: Assessment), which identifies considerations and thresholds in respect of changes in the volume and composition of traffic. Where there are no set criteria, professional judgement has been used in line with best practice and industry standards.

5.4.1.2 In assessing the environmental effects of traffic and transport, two factors are considered:

- the sensitivity of receptors/road users within the study area; and
- the anticipated magnitude of change/impact.

5.4.1.3 The above two factors are then combined to give an effect significance that depends on the sensitivity of the receptor and the anticipated magnitude of change.

5.4.2 Receptor Sensitivity

5.4.2.1 Each of the highway links identified in the study area has been assigned an environmental value (sensitivity).

5.4.2.2 The sensitivity of a highway link is dependent on the scale/importance of a receptor, which in transport terms refers to the road users of the given highway link. Depending on the type of environmental impact, receptors can be either motorised or non-motorised users.

5.4.2.3 The sensitivity of the receptor/road user can be defined by their vulnerability such as elderly people, wheelchair users or children. It also takes account of the existing nature of the road; for example, an existing A-class road is likely to have a lower sensitivity than a minor residential road.

5.4.2.4 In addition, sensitive locations have been considered where pedestrian or cyclist activity may be high, for example, in the vicinity of schools, hospitals, churches, recreational sites and shopping areas, and/or where there is an existing collision issue. Figure 2 in Appendix A shows the sensitive locations in the vicinity of the Project. The general criteria used to assess receptor/road user sensitivity is described in Table 9.

Table 9: Criteria for Determining Receptor / Road User Sensitivity

Sensitivity	Criteria
High	The receptor has little ability to absorb change without fundamentally altering its present character or is of high importance. Receptors of greatest sensitivity to traffic flow are where they are adjacent to schools, colleges, playgrounds, collision clusters, retirement homes, roads without footways that are used by pedestrians.
Moderate	The receptor has moderate capacity to absorb change without significantly altering its present character or is of high importance. Traffic flow sensitive receptors include: congested junctions, doctors' surgeries, hospitals, shopping areas with roadside frontage, roads with narrow footways, recreation facilities and busy transport interchanges.
Low	The receptor is tolerant of change without detriment to its character, is of low or local importance. Receptors with low sensitivity to traffic flow include: places

Sensitivity	Criteria
	of worship, public open space, tourist attractions and residential areas with adequate footway provision.

5.4.2.5 The identified sensitive receptors in the vicinity of the Project are described in Section 6.3.

5.4.3 Magnitude of Change

5.4.3.1 To assist with identifying the magnitude of change as a result of the Project with regard to traffic and transport, reference has been made to the IEMA Road Traffic Guidelines (Section 4: Assessment), which identifies considerations and thresholds in respect of changes in the volume and composition of traffic. Where there are no set criteria, professional judgement has been used in line with best practice and industry standards.

5.4.3.2 The criteria used to assess how far an impact deviates from the baseline condition i.e. the magnitude of change, are described below.

5.4.4 Severance

5.4.4.1 In terms of severance, this is defined as the perceived division that can occur within a community when it becomes separated by a major traffic artery. This may result from the difficulty of crossing a heavily trafficked road or a physical barrier created by the road itself.

5.4.4.2 The measurement and prediction of severance includes an assessment of a range of factors, some of which are related to an individual's perception and therefore difficult to quantify. Relevant factors can include road width, traffic flow, speed, the presence of crossing facilities, and the number of movements across the affected route.

5.4.4.3 The IEMA Road Traffic Guidelines (Section 4: Assessment) suggest that changes in traffic flow of 30%, 60% and 90% are regarded as producing 'minor', 'moderate' and 'major' changes in severance respectively. These percentages have been used to assess the likely effects of the Project in terms of severance.

5.4.5 Pedestrian/Cycle Delay

5.4.5.1 Changes in the volume, composition or speed of traffic may affect the ability of people and/or cyclists to crossroads, and therefore, increases in traffic levels are likely to lead to greater increases in delay. Delays will also depend upon the general level of pedestrian/cycle activity, visibility and general physical conditions of the crossing location.

5.4.5.2 The Guidelines also state that delays are only likely to be significant when the traffic on the network is already at, or close to, the capacity of the system.

5.4.5.3 Given the range of local factors and conditions that can influence pedestrian delay, the IEMA Road Traffic Guidelines (Section 4: Assessment) do not recommend that thresholds be used as a means to establish the significance of pedestrian delay but recommend that professional judgement be made to determine the significance of the effect.

5.4.5.4 A two-way traffic flow of 1,400 vehicles per hour has been adopted as a lower threshold for this assessment. Below this flow level, pedestrian/cycle delay is considered unlikely to be a significant factor.

5.4.6 Pedestrian/Cycle Amenity

5.4.6.1 IEMA Road Traffic Guidelines (Section 4: Assessment) define pedestrian amenity as the relative pleasantness of a journey and is considered to be affected by traffic flow, traffic composition, and pavement width/separation from traffic. This can also include pedestrian fear and intimidation if relevant to the assessment.

5.4.6.2 The guidelines suggest a tentative threshold for assessing the significance of changes in pedestrian amenity where the traffic flow is halved or doubled, with the former leading to a beneficial effect and the latter an adverse effect.

5.4.7 Driver Delay

5.4.7.1 Delays to non-development traffic can occur at several points on the local highway network as a result of the additional traffic that would be generated by a development.

5.4.7.2 The IEMA Road Traffic Guidelines (Section 4: Assessment) state that delays are only likely to be significant when the traffic on the network surrounding the development is already at, or close to, the capacity of the system.

5.4.7.3 The theoretical capacity of a road or a particular junction can be determined by assessing the Ratio of Flow Capacity (RFC) or Degree of Saturation (DoS) of a junction. When an RFC/DoS value of 0.85 (85%) or more is experienced, queuing and congestion are likely to occur during busy periods.

5.4.7.4 The anticipated increases in two-way peak hour traffic flows as a result of the Project are expressed as a percentage of two-way peak hour future baseline traffic flows. A threshold value of 10% is generally used to determine whether or not development-generated traffic constitutes a material increase. Where congestion already exists, thresholds of 5% or lower may be considered to be appropriate.

5.4.7.5 It is generally accepted that traffic increases of 2% or less are not considered 'material' since, in practice, changes of this magnitude would be difficult to differentiate from typical daily/hourly fluctuations in background traffic. This percentage impact assessment methodology is usually applied to determine the extent of the study area examined as part of a TA.

5.4.7.6 These impact thresholds have been adopted for the ES in order to quantify anticipated changes in traffic flows as a result of the Project and to provide a guide as to the likely effects in terms of driver delay.

5.4.8 Highway Safety

5.4.8.1 Where a development scheme is expected to produce a change in the character of the traffic on the local road network, as a result of increased Heavy Goods Vehicle (HGV) movements for example, the IEMA Road Traffic Guidelines state that an assessment of road collision rates should be undertaken using recent data.

5.4.8.2 Detailed analysis of the personal injury collision data within the study area has been undertaken as part of the TA and will be summarised in this ES chapter. Consideration is also given to areas with clusters of collisions that could potentially indicate a road safety issue. The assessment of these clusters is based on qualitative evaluation.

5.4.8.3 The assessment of effect significance is based on professional judgement, accounting for local circumstances and factors which may elevate or lessen the collision risks.

5.4.9 Public Transport

5.4.9.1 In terms of public transport, the IEMA Guidelines do not identify specific guidance in this respect but where improvements involve material changes to public transport services and/or if they form part of a mitigation measure to reduce traffic generation (such as a Travel Plan), it may be necessary to consider this.

5.4.9.2 Multi-modal trip generation (including public transport impacts) have been considered as part of the network capacity assessment contained in the TA at Appendix B.

5.4.9.3 The criteria for determining the magnitude of change/impact are set out in Table 10.

Table 10: Criteria for determining magnitude of change/impact

Effect	Magnitude of Change			
	Negligible	Small	Medium	Large
Severance	Change in total traffic flows of 30% or less (Or increase in HGV flows under 10%)	Change in total traffic flows of 30% – 60% (Or increase in HGV flows over 10% based on the sensitivity of the receptors)	Change in total traffic flows of 60% - 90% (Or increase in HGV flows over 10% based on the sensitivity of the receptors)	Change in total traffic flows of 90% or more (Or increase in HGV flows over 10% based on the sensitivity of the receptors)
Pedestrian/Cycle Delay	Two-way traffic less than 1,400 vehicles per hour	A judgement based on the characteristics of routes with a two-way traffic flow of more than 1,400 vehicles per hour		

Effect	Magnitude of Change			
	Negligible	Small	Medium	Large
Pedestrian/Cycle Amenity	Change in total traffic or HGV flows of less than 100%	A judgement based on the routes with greater than 100% change in context of their individual characteristics		
Driver Delay	Change in traffic flow of 2% or less	Change in traffic flow between 2% and 5%	Change in traffic flow between 5% and 10%	Change in traffic flow of 10% or more
Highway Safety	A judgement based on the change in character of traffic on the local road network and the findings of the baseline collision analysis			
Public Transport	A judgement based on the availability of public transport facilities			

5.4.10 Significance Evaluation

5.4.10.1 The significance of the effect is judged on the relationship of the magnitude of impact to the assessed sensitivity and/or importance of the receptor.

5.4.10.2 The predicted significance of the effects is summarised in Table 11.

Table 11: Matrix for determining Effect Significance

Receptor / Road User Sensitivity	Magnitude of Change Impact			
	Negligible	Small	Medium	Large
High	Negligible	Moderate	Major	Major
Medium	Negligible	Minor	Moderate	Major
Low	Negligible	Negligible	Minor	Moderate

5.4.10.3 Potential effects are therefore concluded to be of negligible, minor, moderate or major significance and can be either beneficial or adverse. Moderate and major effects are considered to be 'significant' in EIA terms.

5.4.10.4 In terms of timescales, potential effects can be described as short, medium, long-term or permanent as shown below:

- Short-term – less than 12 months;
- Medium-term – 1 to 5 years;
- Long-term – more than 5 years;
- Permanent - effects that are 'irreversible' or extremely long-lasting; and/or
- Temporary.

5.4.11 Assessment limitations (technical deficiencies or lack of knowledge)

- 5.4.11.1 Given the travel behaviour changes as a result of the COVID-19 pandemic where the number of people travelling to/from their homes to work, schools and other destinations has greatly reduced, these changes have not been considered as part of this assessment for robustness. The traffic data used in this assessment is representative of pre-COVID-19 conditions and has been used to represent the current 2022 environmental baseline.
- 5.4.11.2 This assessment has been undertaken using the material made available by the Applicant and members of their project team, together with other readily available and publicly accessible material including existing literature and studies.
- 5.4.11.3 All efforts have been made to ensure that the information used as a basis for the assessment is accurate and up to date.
- 5.4.11.4 Any assumptions adopted in the evaluation of impacts reported in this Traffic and Transport chapter are often implicit and rely on professional judgement. Where it has been necessary to make assumptions, these are documented.

6. BASELINE AND RECEPTORS

6.1 Current Baseline (2022)

6.1.1 Local Highway Network

- 6.1.1.1 A plan showing the local highway network is shown on Figure 3 in Appendix A.
- 6.1.1.2 Stather Road provides the vehicular access route to/from Flixborough Industrial Estate and the Port.
- 6.1.1.3 HGVs currently take access to/from the south along Stather Road via Neap House and the B1216 Ferry Road West. A 7.5T weight restriction is imposed along Stather Road to the east through Flixborough village.
- 6.1.1.4 The existing section of Stather Road via Neap House is approximately 5.3m wide making it too narrow for two-way HGV movements so there are currently traffic signals provided at this location to control vehicle movements in either direction.
- 6.1.1.5 A detailed description of the local highway network and existing uses at the Project is included in the TA at Appendix B.

6.1.2 Walking and Cycling

- 6.1.2.1 A plan showing the existing pedestrian and cycle infrastructure in the vicinity of the Project is shown on Figure 4 in Appendix A.
- 6.1.2.2 There are existing pedestrian footway connections to/from National Cycle Network (NCN) Route 169 via a number of residential streets between Ferry Road West and Luneburg Way, which also provide quiet routes for cyclists.
- 6.1.2.3 NCN Route 169 is located approximately 2.8km to the east of the Project. The route is known locally as the Scunthorpe Ridgeway and travels north to south through Scunthorpe; it passes through green open spaces and is approximately 8km in length. The route follows (off road) Normanby Road (2.8km to the east of the Project), it then crosses the A1077 Phoenix Parkway just east of the Luneburg Way / A1077 Roundabout via a toucan crossing. The route then continues southwards off road to the A18 Kingsway where a segregated cycleway is provided, which is separated from the road by a grass verge. It then continues south off-road to Burringham Road.
- 6.1.2.4 There are also a number of Public Rights of Way (PRoW) routes which exist in the vicinity of the Site, as indicated on Figure 4 in Appendix A.
- 6.1.2.5 A plan showing the areas that can be reached within a 10, 20, and 30-minute walk based on typical walking speeds is shown on Figure 5 in Appendix A.
- 6.1.2.6 The walking isochrones show that Flixborough village is within a 20-minute walk and Ferry Road West to the south of the A1077 is within a 30-minute walk.

6.1.2.7 Whilst Scunthorpe and Althorpe railway stations are outside reasonable walking distances, they are accessible within a 20–25-minute cycle as indicated on the Cycling Isochrones plan shown on Figure 6 in Appendix A. Scunthorpe town centre is also located approximately 20-25 minutes cycle ride from the Site, where a wide range of amenities can be found.

6.1.3 Public Transport

Bus

6.1.3.2 The nearest bus route serving the Project (Bus Route 60) runs along Stather Road adjacent to Flixborough Industrial Estate / Flixborough Port. Bus Route 60 runs north-south from Whitton via Burton upon Stather and Flixborough to Scunthorpe via the bus and railway stations, and on to John Leggott sixth form college situated to the south of Scunthorpe town -centre.

6.1.3.3 The 'Flixborough Stather Wharf' bus stops are situated on Stather Road adjacent to the Flixborough Port access. There is no physical bus infrastructure provided at this location (such as bus stops etc.) as this bus route forms part of NLC's rural bus network, which operates an on-demand bus service via 'JustGo North Lincs'.

6.1.3.4 The 'JustGo North Lincs' on demand bus service allows passengers to book and pay online for their bus journey through the JustGo mobile app, as well as choosing where they are picked up from. The service can be booked up to 30 days in advance up until the day of departure.

6.1.3.5 There are additional bus services (Routes 7 and 8) available via Ferry Road West with bus stops located approximately 90 metres south of the A1077. These bus stops are within a 10-minute cycle ride / 30-minute walk of the Site. A summary of the bus routes and service frequencies in the vicinity of the Project is set out below in Table 12.

Table 12: Bus Routes and Service Frequencies

Bus Route	Monday to Friday	Saturday
60 Scunthorpe bus station via Flixborough to Whitton	Northbound	
	First Bus from Scunthorpe bus station: 1000 Arriving at Flixborough Stather Wharf at 1015 Then at 1115 1220 1450 1645 1645 and 1800 towards Whitton	Same timetable as Weekday
	Southbound	
	First Bus from Whitton: 0730 Arriving at Flixborough Stather Wharf at 0800 Then at 0939 1045 1145 1318 and 1543 towards Scunthorpe	Same timetable as Weekday
7 Scunthorpe bus station to Skippingdale Retail Park	Northbound Only	
	First Bus from Scunthorpe bus station: 0905 Arriving at Ferry Road West at 0922 Then hourly from Scunthorpe bus station with last bus at 1805	First Bus from Scunthorpe bus station: 09:10 Arriving at Ferry Road West at 0924 Then hourly from Scunthorpe bus station with last bus at 1810
8 Scunthorpe bus station to Skippingdale Retail Park	Northbound	
	First Bus from Scunthorpe bus station: 0935 Arriving at Ferry Road West at 0951 Then hourly with last bus from Scunthorpe at 1735	First Bus from Scunthorpe bus station: 09:50 Arriving at Ferry Road West (Charnwood Caravan Park) at 10:04 Then hourly with last bus towards Scunthorpe at 1850
	Southbound	
	First Bus from Skippingdale Retail Park: 0927 Arriving at Ferry Road West (Charnwood Caravan Park) at 0929 Then hourly with last bus towards Scunthorpe at 1829	First Bus from Skippingdale Retail Park: 0929 Arriving at Ferry Road West (Charnwood Caravan Park) at 0931 Then hourly with last bus towards Scunthorpe at 1831

* there are currently no bus services operating on a Sunday

National Rail

- 6.1.3.6 Althorpe railway station is the nearest station serving the Site, which is located approximately 4.3 kilometres south-west of the Project on the opposite side of the River Trent, adjacent to Keadby Bridge. It is approximately a 20-minute cycle ride from the Project via Stather Road and the B1216 Neap House.
- 6.1.3.7 Scunthorpe railway station is located a short walk from Scunthorpe town centre, which is approximately 4.5 kilometres south-east of the Project and can be reached by bus (approximately 15 to 20-minute bus journey) or by cycle (approximately 25-minute cycle ride).
- 6.1.3.8 Scunthorpe and Althorpe stations are both served by Northern Trains (NT) and the TransPennine Express (TPE).
- 6.1.3.9 Scunthorpe station has two platforms, Platform 1 serves mainly TPE eastbound trains towards Grimsby / Cleethorpes with some NT westbound services towards Doncaster. All westbound TPE services, and most NT services use Platform 2. There is an hourly TPE service eastward to Cleethorpes and westbound there is an hourly TPE service to Manchester Piccadilly and Manchester Airport, with an hourly local NT service calling at all intermediate stations towards Doncaster. Trains operate throughout the week (Monday to Sunday).
- 6.1.3.10 Scunthorpe station has step free access from the station entrance to all platforms.
- 6.1.3.11 Althorpe railway station is mainly served by NT, which operates east-west from Scunthorpe via Althorpe, Crowle to Doncaster and onward connections to Sheffield. There are also occasional TPE services via this station. Train services operate Monday to Saturday with an hourly service.
- 6.1.3.12 Althorpe station has two platforms, Platform 1 (eastbound) and Platform 2 (westbound) and the station does not currently provide step free access with Platform 1 only accessible by a footbridge with steps.
- 6.1.3.13 Table 13 provides an overview of the train frequencies at these railway stations.

Table 13: Train Frequencies at Scunthorpe and Althorpe Stations

Destination	Weekday AM	Weekday PM	Saturday	Sunday
Scunthorpe Station				
Doncaster	Every 30 Minutes	Every 30 Minutes	Every 30 Minutes	Hourly
	First Train: 05:47	Last Train: 22:48	First Train: 05:47 Last Train: 22:48	First Train: 10:07 Last Train: 21:58
Cleethorpes	Hourly	Hourly	Hourly	Hourly
	First Train: 06:19 Last Train: 23:12	First Train: 06:19 Last Train: 23:12	First Train: 06:19 Last Train: 23:12	First Train: 10:04 Last Train: 23:05

Destination	Weekday AM	Weekday PM	Saturday	Sunday
Manchester Piccadilly	Hourly	Every 30 Minutes	Every 30 Minutes	Hourly *
	First Train: 05:47	Last Train: 22:48	First Train: 05:47 Last Train: 22:48	First Train: 10:07 Last Train: 21:08
Althorpe Station				
Doncaster	Hourly	Hourly	Hourly	No services
	First Train 05:52	Last Train 22:53	First Train: 05:52 Last Train: 23:06	

* Intermediate Changes are required

6.1.4 Highway Safety

- 6.1.4.1 Collision data were obtained from NLC for the junctions and highway links within the study area for the latest five-year period to September 2021 and this has been fully assessed in the TA at Appendix B.
- 6.1.4.2 It shows that there was a total of 62 collisions recorded at the junctions in the study area across the five-year period to September 2021. The majority of these collisions appear to be as a result of general driver error rather than a particular collision trend/road layout issue.
- 6.1.4.3 There were no collisions recorded in the vicinity of the Project along Stather Road. There were two collisions recorded at the Bellwin Drive / First Avenue junction (involving slight injury).
- 6.1.4.4 Whilst there were five collisions recorded at the B1216 Ferry Road West / A1077 signal junction (four involving slight injury, one serious), three of these (including the serious injury incident) occurred prior to the installation of traffic signals control at this junction i.e. pre-2019 when this junction operated as a staggered priority junction.
- 6.1.4.5 In summary, the highway network within the study area does not have a significant personal injury collision record over the five-year period. Whilst there were some common attributes between the collisions recorded during the study period, the highway layout would not appear to be a contributory factor.

6.1.5 Freight Transport by River

- 6.1.5.1 Due to the strategic location of the Project adjacent to the River Trent, there is the opportunity to adopt river-based transport of freight.
- 6.1.5.2 Marine traffic enters the River Trent from the River Humber located north and downstream of the Flixborough Wharf. Between Flixborough and the River Humber, there is only one additional facility located at Burton Stather, the Kings Ferry Wharf. The River Trent enables two-way traffic. Associated British Ports Ltd (ABP) is the Statutory Harbour Authority for the Humber Estuary, administered by ABP Humber Estuary Services.

6.1.5.3 The current operations at the Flixborough Wharf are as follows:

- offloading of bulk materials;
- offloading/loading of steel; and
- monthly delivery of pig iron.

6.1.5.4 The average vessel at Flixborough Wharf handles a volume of 1,500 to 2,000 metric tonnes (mt). But there is the capacity for up to 3,000mt with the largest vessels.

6.1.5.5 The existing wharf length is 180m and two average size vessels (80-85m) can moor at the same time without any problem.

6.1.5.6 The number of vessel movements in the River Humber and River Trent are included in the preliminary Navigation Risk Assessment at Annex 6 of the ES (**Documents Reference 6.3.6**), which indicates that the number of vessel movements in the Humber Estuary and the River Trent has significantly decreased in the last 20 years.

6.1.6 Freight Transport by Rail

6.1.6.1 Flixborough Wharf was originally connected to a much larger local industrial rail network, which also served the nearby chemical and steelworks facilities (refer to Figure 7 in Appendix A).

6.1.6.2 The Wharf retains a disused rail connection to the national rail network via a 6km single-track branch line (last reported in use around 2012) to exchange sidings at Dragonby (partially still in use by Vossloh) and a main line connection with Network Rail infrastructure known as Normanby Park Ground Frame (still in use by Vossloh). From this point, the Flixborough Wharf branch line links to the operational freight-only Network Rail branch line linking the landfill site at Roxby Gullet (in use by BIFFA) with the main Scunthorpe to Doncaster mainline at Trent Junction.

6.2 Future Baseline (2028)

6.2.1.1 The future baseline accounts for changes that would occur irrespective of the Project coming forward.

6.2.1.2 There are no notable changes anticipated to the local highway infrastructure in 2028 to that described in the existing baseline conditions other than that associated with the proposed Lincolnshire Lakes development

6.2.1.3 As part of the Lincolnshire Lakes development, a new roundabout has been constructed on the M181, to the north of Brumby Common Lane, located approximately 2km north of the M180. Whilst the east-west approaches at the roundabout are in place, these are not currently in use but will become operational once the Lincolnshire Lakes development is completed. As part of these works, the section of road between this new roundabout and the A18 to the north has been downgraded from a trunk road (M181) to normal highway (A1077) under NLC's control.

6.3 Identified Sensitive Receptors

6.3.1.1 Based on the sensitivity of receptors/road users described earlier, a desktop study has been undertaken to identify the level of sensitivity for each of the highway links within the study area.

6.3.1.2 The level of sensitivity has been assigned based on professional judgement of the sensitivity of the different receptors /road users in the context of transport networks in the vicinity of the Site.

6.3.1.3 The sensitivity of the highway links in the study area is shown in Table 14.

6.3.1.4 Potential effects of additional traffic on the highway network further afield have not been assessed as the effects would be negligible given that Project traffic would dissipate across a variety of locations.

Table 14: Highway Links and their Sensitivity

Highway Link	Sensitivity
Bellwin Drive	Low
First Avenue (West of Bellwin Drive)	Low
Stather Rd (West of New Access Rd)	Low
Stather Rd (East of New Access Rd)	Low
First Avenue (East of Bellwin Drive)	Low
New Access Road	Low
Stather Road (West of Neap House)	Low
B1216 Ferry Road West (West of New Access Rd)	Low
A1077 (South of B1216))	Low
A1077 (North of B1216)	Low
Ferry Road West (east of A1077)	Medium
Holyrood Drive	Low
Luneburg Way	High
A1077 (east of Luneberg Way)	Low
A18 Kingsway (West)	Low
A1077 (south of A18)	Low
A18 Doncaster Road (west of A1077)	Low
A159 Ashby Road (south of A18)	Low
A18 Queensway (east of A159)	Low
Ashby Road (north of A18)	Low
A18 Kingsway West (west of A159)	Low
Ferry Road West (east of New Access Road)	Low
M181 (north of M180)	Low
M180 (W)	Low

Highway Link	Sensitivity
M181 (E)	Low

7. MITIGATION

7.1.1.1 This section describes the mitigation measures considered in the assessment. This includes mitigation that is integral to the design of the Project and good practice mitigation measures that the Project is committed to adopting.

7.2 Construction Phase

7.2.1.1 An outline CLP (Appendix D to this chapter) has been submitted with the Application, which sets out the logistics activity and management during the construction phase. It also includes a number of measures to mitigate the environmental impact of construction activities.

7.2.1.2 The outline CLP confirms that a Construction Traffic Management Plan (CTMP) would be developed prior to the commencement of construction, which will define the hours during which deliveries can be made to and from the site and also the routes that vehicles will take. Deliveries will be timed to avoid the peak times for pedestrian movement (such as school start and finish times) as far as possible so as to limit the impact of the additional HGV movements on pedestrian /cycle delay and amenity.

7.2.1.3 All construction vehicle operators will be required to be accredited in line with FORS (Freight Operator Recognition Scheme) to demonstrate their commitment to using clean, safe vehicles with good levels of direct vision, safety bars and advisory signage (as stipulated in the outline CLP) unless a specific exception is agreed with NLC prior to that haulier or supplier visiting site. This will seek to minimise the risk of collisions between vehicles and vulnerable road users, such as cyclists and pedestrians.

7.2.1.4 In terms of construction workforce, whilst the majority of travel is expected to fall outside the highway peak hours, the outline CLP the outline CLP at Appendix D outlines a number of measures being considered to help reduce the impact of construction workforce traffic as set out below:

- provision of a shuttle bus service/park and ride facility during peak construction periods to transport workforce from a car parking location off-site;
- construction Workers Travel Plan to encourage the use of non-car modes; and
- staggered arrival/departure times for construction workers wherever possible to help minimise any impacts on the local highway network during highway peak periods.

7.2.1.5 The demolition and construction assessment contained in this Traffic and Transport Chapter has been completed under the assumption that this outline CLP is developed into further detail by the construction contractor and fully implemented.

7.2.1.6 The proposed New Access Road for the Project will be constructed at the start of the construction phase in 2024 so that it can be used by construction vehicles during the peak construction period.

7.3 Operational Phase

7.3.1.1 The Project includes the following mitigation:

- The New Access Road is intended to serve the existing Flixborough Industrial Estate and Port area as well as the Project. It will remove existing traffic from Stather Road via Neap House, which is very narrow and generally unsuitable for two-way heavy goods vehicle movements. The New Access Road will include a new priority junction with a ghost island right turn arrangement at its northern end where it joins Stather Road and a new 3-arm roundabout at its southern end on the B1216 Ferry Road West mid-way between the A1077 signal junction and Neap House Roundabout;
- Stopping up the section of highway on Stather Road between Flixborough Industrial Estate and the existing surface water pumping station situated 160 metres north of Neap House but will be maintained as an access to allow walking and cycling along the River Trent in a north – south direction;
- A new 3m wide shared pedestrian/cycle footway along the eastern side of the carriageway of the New Access Road, which will extend westbound along Stather Road and connect to the existing footways on Bellwin Drive;
- A new 3m wide shared pedestrian/cycle footway along the northern side of the B1216 Ferry Road West, connecting westward to Neap House and eastward to the A1077;
- A new toucan crossing facility at the A1077 / B1216 Ferry Road West signal junction to enable pedestrians and cyclists to cross the A1077, which includes minor alterations to the junction layout and signal staging to suit;
- Provision of on-site car, motorcycle and cycle parking facilities in accordance with NLC's Parking Provision Guidelines. Whilst the Project does not fall within a specific land use classification, an appropriate level of car parking is proposed at the Project based on the bespoke operations. This will include disabled parking as well as electric vehicle charging infrastructure;
- A new pedestrian / cycle public right of way will be created orientated west – east, which will run from Stather Road to the New Access Road, continuing to the open land at Foxhills Plantation / Atkinson's Warren, providing a new circular walking route and connectivity between the River Trent and the northern edge of Scunthorpe;
- A new public right of way will be provided to the east of Flixborough Industrial Estate, connecting footpath FLIX/175 and FLIX/304, providing a new link that avoids the need for walking along Stather Road;
- Reinstatement of the existing 6km Dragonby to Flixborough branch line and provision of continued amenity access across the branch line. This will include the provision of an upgrade to the existing at grade infrastructure for the footpath (FLIX175) crossing to the south west of Flixborough and re-establishment of the footpath (FLIX178) crossing to the south east of Flixborough through the provision of a pedestrian bridge. These measures are required to ensure that the crossings meet the appropriate safety standards and to reduce the risk of the public crossing the rail line once it has been re-commissioned; and

- The construction and operation of a new railhead to the south of Flixborough Wharf, with the primary purpose of facilitating the delivery and export of materials to and from the Project to reduce the need for road vehicle movements. This will also increase the capacity for trains to stand down to allow commercial trains to operate on the main lines and therefore will help to minimise rail movements overnight at the ERF.

8. ASSESSMENT OF LIKELY EFFECTS

8.1 Demolition and Construction Effects

8.1.1 Local Highway Network

8.1.1.1 The anticipated construction programme together with the anticipated phasing and management for the construction activities is set out in Chapter 3 (**Document Reference 6.2.3**) and the Indicative Phasing Plan (**Document Reference 4.9**). This information is also provided in the outline CLP at Appendix D.

8.1.1.2 The construction of the Project will lead to additional construction vehicle movements on the highway network. Construction related traffic will comprise employee transport, deliveries and disposal of construction materials and excess excavated material.

8.1.1.3 The potential use of the railway and/or river to support construction logistics is still under consideration. Whilst the Energy Park is conveniently located adjacent to Flixborough Wharf on the River Trent, the tidal range is significant, which limits the operational window for vessel access and unloading. The use of river transport could replace a significant number of HGV movements on the highway network thanks to the large capacity of the cargo vessels. The practicalities of material handling at Flixborough Wharf (sufficient yard area, internal access roads) and transferring to/from the Project Site are still being evaluated.

8.1.1.4 The assessments of effects in relation to river and rail modes are set out in Sections 8.1.2 and 8.1.3 of this Traffic and Transport chapter.

8.1.1.5 The assessment of effects on the local highway network has been undertaken based on a worst-case (robust) assumption, which assumes that all (100%) construction materials would be transported by road.

8.1.1.6 The outline CLP at Appendix D sets out the preliminary forecast of construction vehicles. It is acknowledged in the outline CLP that these are preliminary estimates which will be developed and updated as the design progresses to be included in the detailed CLP as part of the construction traffic management plan (CMTP) to be submitted prior to commencement of the works.

8.1.1.7 Vehicular activity has been assessed over two main components – construction deliveries (including materials, plant, etc.) and workforce travel – as these are predicted to have very different characteristics.

8.1.1.8 Workforce traffic will mostly be car and Light Goods Vehicles (LGVs) generally focussed towards the start and end of the working day, whereas delivery vehicles (HGV movements) would be spread across the entire working day.

8.1.1.9 HGVs will comprise a range of vehicles including rigid vehicles, articulated vehicles and skip lorries.

8.1.1.10 A summary of the typical monthly and daily activity across each of the six years of the construction programme is provided below in Table 15.

Table 15: Peak Construction Traffic per Year

	Construction vehicles per month		Peak construction vehicles per day	
	Delivery vehicles	Workforce vehicles	Delivery vehicles	Workforce vehicles
Year 1 (2023)	650-1,080	660-4,420	30-50	35-220
Year 2 (2024)	985-2,260	5,040-9,700	45-105	250-485
Year 3 (2025)	280-2,240	10,230-15,160	15-105	510-760
Year 4 (2026)	130-775	11,730-16,020	10-40	585-800
Year 5 (2027)	130-1,680	440-10,800	10-80	20-540
Year 6 (2028)	50-560	440-1,100	5-30	20-55

8.1.1.11 The construction effects of the Project have been assessed against the 2025 and 2026 future baseline situation, which represents the peak year (s) in terms of construction traffic. It is noted that whilst the total vehicle trips during construction are higher in 2026, the HGV content is higher in 2025 and therefore both years have been assessed.

8.1.1.12 The increase in construction traffic in 2025 and 2026 is shown below in Table 16 to Table 19 respectively. The highway links with medium / high sensitivity are indicated in blue, all others are low sensitivity.

Table 16: 2025 Construction Traffic Flows (Annual Average Daily Traffic (AADT))

Highway Link	2025 Baseline Flows		Additional Construction Vehicles		% Increase	
	Total Vehs	HGV	Total Vehs	HGV	Total Vehs	HGV
Bellwin Drive	3,905	537	0	0	0%	0%
First Avenue (West of Bellwin Drive)	530	71	0	0	0%	0%
Stather Rd (West of New Access Rd)	0	0	0	0	0%	0%
Stather Rd (East of New Access Rd)	1,418	102	0	0	0%	0%
First Avenue (East of Bellwin Drive)	448	45	0	0	0%	0%
New Access Road	5,230	626	1,112	84	21.3%	13.4%
Stather Road (West of Neap House)	73	0	0	0	0%	0%
B1216 Ferry Rd West (West of New Access Rd)	3,532	527	0	0	0%	0%
A1077 (South of B1216)	19,032	2,850	795	75	4.2%	2.6%
A1077 (North of B1216)	15,042	2,099	317	8	2.1%	0.4%
Ferry Road West (east of A1077)	2,897	199	0	0	0%	0%
Holyrood Drive	6,706	192	0	0	0%	0%
Luneburg Way	8,760	192	21	0	0.2%	0%
A1077 (east of Luneburg Way)	18,125	2,016	111	8	0.6%	0.4%
A18 Kingsway (West)	27,167	1,638	103	0	0.4%	0%
A1077 (south of A18)	26,039	3,457	631	75	2.4%	2.2%
A18 Doncaster Road (west of A1077)	13,048	733	62	0	0.5%	0%
A159 Ashby Road (south of A18)	18,980	819	10	0	0.1%	0%
A18 Queensway (east of A159)	24,874	948	72	0	0.3%	0%
Ashby Road (north of A18)	26,500	840	10	0	0.1%	0%

Highway Link	2025 Baseline Flows		Additional Construction Vehicles		% Increase	
	Total Vehs	HGV	Total Vehs	HGV	Total Vehs	HGV
A18 Kingsway West (west of A159)	18,926	716	103	0	0.5%	0%
B1216 Ferry Road West (east of New Access Rd)	5,141	1,065	1,112	84	21.7%	7.9%
M181 (north of M180)	26,360	3,496	631	75	2.4%	2.1%
M180 (W)	49,396	12,218	371	38	0.8%	0.3%
M181 (E)	39,135	9,881	260	38	0.6%	0.4%

Table 17: 2025 Construction Traffic Flows (Annual Average Weekly Traffic (AAWT))

Highway Link	2025 Baseline Flows		Additional Construction Vehicles		% Increase	
	Total Vehs	HGV	Total Vehs	HGV	Total Vehs	HGV
Bellwin Drive	4,187	624	0	0	0%	0%
First Avenue (West of Bellwin Drive)	568	83	0	0	0%	0%
Stather Rd (West of New Access Rd)	0	0	0	0	0%	0%
Stather Rd (East of New Access Rd)	1,511	118	0	0	0%	0%
First Avenue (East of Bellwin Drive)	478	53	0	0	0%	0%
New Access Road	5,598	727	1,415	107	25.3%	14.8%
Stather Road (West of Neap House)	78	0	0	0	0%	0%
B1216 Ferry Rd West (West of New Access Rd)	2,733	613	0	0	0%	0%
A1077 (South of B1216))	20,431	3,312	1,012	96	4.5%	2.9%
A1077 (North of B1216)	16,132	2,439	403	11	2.5%	0.5%
Ferry Road West (east of A1077)	3,086	231	0	0	0%	0%

Highway Link	2025 Baseline Flows		Additional Construction Vehicles		% Increase	
	Total Vehs	HGV	Total Vehs	HGV	Total Vehs	HGV
Holyrood Drive	7.114	223	0	0	0%	0%
Luneburg Way	9.287	223	26	0	0.3%	0%
A1077 (east of Luneberg Way)	20,865	2.343	142	11	0.7%	0.5%
A18 Kingsway (West)	28.915	1.904	127	0	0.4%	0%
A1077 (south of A18)	27.908	4.017	803	96	2.9%	2.4%
A18 Doncaster Road (west of A1077)	13.879	851	79	0	0.6%	0%
A159 Ashby Road (south of A18)	20.165	952	13	0	0.1%	0%
A18 Queensway (east of A159)	26.414	1.102	92	0	0.3%	0%
Ashby Road (north of A18)	28.250	1.104	13	0	0.1%	0%
A18 Kingsway West (west of A159)	19.045	833	131	0	0.7%	0%
B1216 Ferry Road West (east of New Access Rd)	5.952	1.157	1415	107	23.8%	9.2%
M181 (north of M180)	28.231	4.063	803	96	2.8%	2.4%
M180 (W)	52.901	14.198	472	48	0.9%	0.3%
M181 (E)	41.912	11.483	331	48	0.8%	0.4%

Table 18: 2026 Construction Traffic Flows (AADT)

Highway Link	2026 Baseline Flows		Additional Construction Vehicles		% Increase	
	Total Vehs	HGV	Total Vehs	HGV	Total Vehs	HGV
Bellwin Drive	3923	537	0	0	0%	0%
First Avenue (West of Bellwin Drive)	530	71	0	0	0%	0%
Stather Rd (West of New Access Rd)	0	0	0	0	0%	0%

Highway Link	2026 Baseline Flows		Additional Construction Vehicles		% Increase	
	Total Vehs	HGV	Total Vehs	HGV	Total Vehs	HGV
Stather Rd (East of New Access Rd)	1,423	104	0	0	0%	0%
First Avenue (East of Bellwin Drive)	448	45	0	0	0%	0%
New Access Road	5,488	710	1,181	21	21.5%	3%
Stather Road (West of Neap House)	73	0	0	0	0%	0%
B1216 Ferry Rd West (West of New Access Rd)	3,541	527	0	0	0%	0%
A1077 (South of B1216))	19,552	2,904	831	19	4.3%	0.7%
A1077 (North of B1216)	15,461	2,114	350	2	2.3%	0.1%
Ferry Road West (east of A1077)	2,945	214	0	0	0%	0%
Holyrood Drive	6741	192	0	0	0%	0%
Luneburg Way	8,949	194	23	0	0.3%	0%
A1077 (east of Luneberg Way)	18,631	2,030	118	2	0.6%	0.1%
A18 Kingsway (West)	27,498	1,646	116	0	0.4%	0%
A1077 (south of A18)	26,693	3,502	645	19	2.4%	0.5%
A18 Doncaster Road (west of A1077)	13,206	736	70	0	0.5%	0%
A159 Ashby Road (south of A18)	19,029	821	12	0	0.1%	0%
A18 Queensway (east of A159)	25,047	952	81	0	0.3%	0%
Ashby Road (north of A18)	26,539	841	12	0	0.1%	0%
A18 Kingsway West (west of A159)	19,188	722	116	0	0.6%	0%
B1216 Ferry Road West (east of New Access Rd)	5,590	1,149	1,181	21	21.1%	1.8%
M181 (north of M180)	27,094	3,551	645	19	2.4%	0.5%
M180 (W)	49,767	12,245	385	9	0.8%	0.1%
M181 (E)	39,481	9,900	260	9	0.7%	0.1%

Table 19: 2026 Construction Traffic Flows (AAWT)

Highway Link	2026 Baseline Flows		Additional Construction Vehicles		% Increase	
	Total Vehs	HGV	Total Vehs	HGV	Total Vehs	HGV
Bellwin Drive	4,206	624	0	0	0%	0%
First Avenue (West of Bellwin Drive)	568	83	0	0	0%	0%
Stather Rd (West of New Access Rd)	0	0	0	0	0%	0%
Stather Rd (East of New Access Rd)	1,516	120	0	0	0%	0%
First Avenue (East of Bellwin Drive)	478	53	0	0	0%	0%
New Access Road	5,897	825	1,503	27	25.5%	3.3%
Stather Road (West of Neap House)	78	0	0	0	0%	0%
B1216 Ferry Rd West (West of New Access Rd)	2,741	613	0	0	0%	0%
A1077 (South of B1216))	20,997	3,374	1,057	24	5.0%	0.7%
A1077 (North of B1216)	16,580	2,457	446	3	2.7%	0.1%
Ferry Road West (east of A1077)	3,141	249	0	0	0%	0%
Holyrood Drive	7,151	223	0	0	0%	0%
Luneburg Way	9,488	225	30	0	0.3%	0%
A1077 (east of Luneberg Way)	20,865	2,359	150	3	0.8%	0.1%
A18 Kingsway (West)	29,268	1,914	148	0	0.5%	0%
A1077 (south of A18)	28,613	4,070	821	24	2.9%	0.6%
A18 Doncaster Road (west of A1077)	14,047	855	89	0	0.6%	0%
A159 Ashby Road (south of A18)	20,217	954	15	0	0.1%	0%
A18 Queensway (east of A159)	26,598	1,106	103	0	0.4%	0%
Ashby Road (north of A18)	28,293	1,106	15	0	0.1%	0%

Highway Link	2026 Baseline Flows		Additional Construction Vehicles		% Increase	
	Total Vehs	HGV	Total Vehs	HGV	Total Vehs	HGV
A18 Kingsway West (west of A159)	19,310	840	148	0	0.8%	0%
B1216 Ferry Road West (east of New Access Rd)	6,318	1,282	1,503	27	23.8%	2%
M181 (north of M180)	29,029	4,127	821	24	2.9%	0.6%
M180 (W)	53,306	14,230	490	12	1%	0.1%
M181 (E)	42,288	11,504	331	12	0.8%	0.1%

8.1.1.13 In terms of severance, the change in traffic flows is shown to be negligible on all highway links in 2025 and 2026.

8.1.1.14 In terms of driver delay, the change in traffic flows is shown to be negligible on all highway links in 2025 and 2026 with the exception of the following:

- New Access Road = Large Change in Total Vehicles in 2025 (21.3% AADT / 25.3% AAWT) and 2026 (21.5% AADT / 25.5% AAWT)
- Ferry Road West (east of New Access Rd) = Large Change in Total Vehicles in 2025 (21.7% AADT / 23.8% AAWT) and 2026 (21.1% AADT / 23.8% AAWT)
- A1077 (north of B1216) = Small Change in Total Vehicles in 2025 (2.1% AADT / 2.5% AAWT) and 2026 (2.3% AADT / 2.7% AAWT)
- A1077 (south of B1216) = Small Change in Total Vehicles in 2025 (4.2% AADT / 4.5% AAWT) and 2026 (4.3% AADT / 5.0% AAWT)
- A1077 (south of A18) = Small Change in Total Vehicles in 2025 (4.2% AADT / 4.8% AAWT) and 2026 (2.4% AADT / 2.9% AAWT)
- M181 (north of M180) = Small Change in Total Vehicles in 2025 (2.4% AADT / 2.8% AAWT) and 2026 (2.4% AADT / 2.9% AAWT)

8.1.1.15 Given the moderate baseline traffic flows already on these highway links, the change in traffic flow during construction is expected to result in temporary effects of minor to negligible significance on road users along these routes.

8.1.1.16 It is noted that whilst the New Access Road is indicated as having a large change in traffic flow, this is due to it being a newly constructed highway serving the Project and the surrounding area. The anticipated flows on the New Access Road during construction are temporary and well within the road's designed capacity.

8.1.1.17 Whilst the change in traffic on the B1216 Ferry Road West (east of the New Access Rd) is also shown to be large, this is temporary and can be accommodated satisfactorily within the theoretical capacity of the highway link and its adjoining junctions. It is considered therefore that this will result in a temporary adverse effect of minor significance to driver delay.

8.1.1.18 The increase in construction vehicle movements on local pedestrian and cyclist routes also has the potential to affect the amenity of pedestrians and cyclists. However, this will be a temporary, local adverse effect of negligible significance.

8.1.1.19 An outline CLP (Appendix D to this chapter) has been submitted with the Application, which includes a number of measures to help mitigate the environmental impact of construction activities, including a CTMP to define construction vehicle routes as well as appropriate controls to manage and co-ordinate the movement of vehicles and pedestrians in and around the Project.

8.1.1.20 In terms of construction workforce, whilst the majority of travel is expected to fall outside the highway peak hours, the outline CLP at Appendix D outlines a number of measures being considered to help reduce the impact of construction workforce traffic as set out below:

- Provision of a shuttle bus service/park and ride facility during peak construction periods to transport workforce from a car parking location off-site
- Construction Workers Travel Plan to encourage the use of non-car modes
- Staggered arrival/departure times for construction workers wherever possible to help minimise any impacts on the local highway network during highway peak periods

8.1.1.21 This will seek to reduce potential impacts of construction workforce traffic on the highway network, particularly during highway peak periods.

8.1.1.22 Any service diversions/installations required during construction are likely to require localised temporary lane closures and traffic management. Similarly, for the erection and dismantlement of mobile/tower cranes and/or delivery of AILs, which would occur outside highway peak periods wherever possible.

8.1.1.23 Any temporary closures of footways, footpaths, cycle paths and traffic lanes or suspensions of access restrictions and on street parking would be determined prior to the construction phase in discussion with the highway authority. Any permits and licences deemed necessary, would be progressed in accordance with the processes agreed as part of the Application and to be set out detail in the Construction Environmental Management Plan, (CoCP), to be developed by the construction contractor and approved by NLC (see also Code of Construction Practice (CoCP) at Annex 7 of the ES (**Document Reference 6.3.7**)).

8.1.1.24 No permanent diversion or closure of a PRow is proposed as part the Project. Where localised temporary closures are required, it is expected that a temporary diversion would be sought.

8.1.1.25 Where PRows are to be diverted, the width of any temporary alternatives or diversions will be no less than the existing access provision available where practicable. Where this is not possible, the following minimum widths should apply: Public Footpaths: 2m, Public Bridleways 3m, Restricted Byways 3m.

8.1.1.26 The traffic management measures proposed during the construction phase will seek to minimise disruption to other road users wherever possible, particularly on the strategic road network.

8.1.1.27 Once the New Access Road is nearing completion, the new connections / junctions at Stather Road and the B1216 will be constructed. Suitable construction traffic management measures will be implemented to minimise traffic disruption during this phase and once the New Access Road

opens, Stather Road will then be closed (stopped up) to public traffic north of the existing pumping station.

8.1.1.28 In summary, with the implementation of the outline CLP at Appendix D, the impact on the local highway network during the demolition and construction phase would result in a temporary adverse effect of minor significance to driver delay with a temporary, local adverse effect of negligible significance on severance, highway safety and pedestrian / cycle amenity and delay.

8.1.2 Freight Transport by River

8.1.2.1 Preliminary investigations have indicated that it may be possible to import some of the fill material via the river during the construction phase but the practicalities of this have yet to be evaluated in detail. The potential for this would be favourable from an environmental perspective as it would replace a large amount of road traffic.

8.1.2.2 A spread of fill material import during approximately 4 years of construction (2023-2027) is being assumed with monthly tonnages varying between 5,000mt and 20,000mt depending on the activities taking place, and a maximum total of 100,000mt per year.

8.1.2.3 Based on the assumption that a cargo vessel bringing fill material to Flixborough Wharf would handle an average of 2,500mt, this would represent between 4 and 16 additional vessel movements at Flixborough Wharf per month during the construction phase and a maximum total of 80 vessel movements per year between 2023 and 2027.

8.1.2.4 This increase of vessel movements could be adequately accommodated at Flixborough Wharf during the construction phase and would not require any changes to the yard or the handling equipment.

8.1.3 Freight Transport by Rail

8.1.3.1 As noted in 4.1.1.3 earlier, Rail offers scope to move materials such as construction spoil, aggregates, sand, cement, reinforcement bar and other structural steel. The key dependencies will be the phasing of the works to reinstate the disused branch line from Dragonby Sidings through to the Energy Park, as well as the availability of suitable rail-linked sources of material at sufficient scale and/or distance from the Project to make rail viable for transportation.

8.1.3.2 Based on the assumption that a train bringing fill material to Flixborough Wharf would handle an average of 2,000mt, use of rail would represent between 3 and 20 additional train movements at Flixborough Wharf per month during the construction phase and a maximum total of 50 train movements per year between 2023 and 2027.

8.1.3.3 This increase of train movements could be adequately accommodated at Flixborough Wharf during the construction phase and, depending on the

material and type of rail wagons employed, would not require any changes to the yard or the handling equipment.

8.1.4 Climate Change and Adaption

8.1.4.1 Climate change effects in relation to traffic and transport are considered in Chapter 6: **(Document Reference 6.2.6)**.

8.1.5 Summary of Demolition and Construction Effects

8.1.5.1 Table 20 summarises the effects during demolition and construction.

Table 20: Summary of Effects during Demolition and Construction

Road User / Receptor	Sensitivity	Description of Effect	Magnitude of Change/Impact	Effect Significance
Pedestrians and Cyclists	High	Movement of construction vehicles Monday to Saturday over a 6-year construction programme and implementation of the traffic management plan (including for any temporary footway diversion/partial closure and/or lane closures where appropriate)	Negligible	Temporary, Local Adverse Effect of Negligible Significance to Pedestrian / Cycle Amenity and Delay
Motorised Users on the New Access Road and the B1216 Ferry Road West (east of New Access Road)	Medium		Negligible (Severance / Highway Safety)	Temporary, Local Adverse Effect of Negligible Significance on Severance / Highway Safety
Motorised Users on A1077 (north and south of B1216), A1077 (south of A18) and M181 (north of M180)			Large (Driver Delay - refer to Para 8.1.1.17)	Temporary, Local Adverse Effect of Minor Significance to Driver Delay
			Negligible (Severance/ Highway Safety)	Temporary, Local Adverse Effect of Negligible Significance to Severance / Highway Safety and Minor Significance to Driver Delay
Motorised Users on all other Highway Links within the study area			Small (Driver Delay- refer to Para 8.1.1.14)	Temporary, Local Adverse Effect of Negligible Significance to Driver Delay / Highway Safety / Severance
Public Transport	Medium	Trips associated with construction workers	Negligible	Negligible

Road User / Receptor	Sensitivity	Description of Effect	Magnitude of Change/Impact	Effect Significance
Vessels on River Trent	Low	Movements of vessel importing construction materials	Negligible	Negligible



8.2 Operational Effects

8.2.1 Local Highway Network

8.2.1.1 The assessment of effects on the local highway network has been undertaken based on a worst-case (robust) assumption, which assumes that all freight would be transported by road during operation.

8.2.1.2 The change in traffic flows as a result of the Project in 2028 (year of opening) is shown below in Table 21 and Table 22. The highway links with medium / high sensitivity are indicated in blue, all others are low sensitivity.

Table 21: 2028 Operational Traffic Flows (AADT)

Highway Link	2028 Baseline Flows		Additional Proposed Development Trips		% Increase	
	Total Vehs	HGV	Total Vehs	HGV	Total Vehs	HGV
Bellwin Drive	3,960	537	0	0	0%	0%
First Avenue (West of Bellwin Drive)	530	71	0	0	0%	0%
Stather Rd (West of New Access Rd)	0	0	124	0	100%	0%
Stather Rd (East of New Access Rd)	1,418	102	18	4	0%	0%
First Avenue (East of Bellwin Drive)	448	45	0	0	0%	0%
New Access Road	5,285	626	1,261	558	19.2%	47.1%
Stather Road (West of Neap House)	73	0	0	0	0%	0%
B1216 Ferry Rd West (West of New Access Rd)	3,560	527	0	0	0%	0%
A1077 (South of B1216))	20,135	2,850	822	377	4.1%	11.7%
A1077 (North of B1216)	16,167	2,099	274	145	1.7%	6.5%
Ferry Road West (east of A1077)	2,908	199	165	36	5.4%	15.3%
Holyrood Drive	6,812	192	0	0	0%	0%
Luneburg Way	9,313	192	18	4	1.3%	0%
A1077 (east of Luneburg Way)	19,525	2,016	255	141	1.3%	6.5%
A18 Kingsway (West)	28,099	1,642	107	49	0.4%	2.8%
A1077 (south of A18)	27,626	3,461	687	323	2.4%	9.2%
A18 Doncaster Road (west of A1077)	13,494	733	34	7	0.3%	0.9%
A159 Ashby Road (south of A18)	19,120	820	13	6	0.1%	0.7%
A18 Queensway (east of A159)	25,363	949	51	22	0.2%	2.3%

Highway Link	2028 Baseline Flows		Additional Proposed Development Trips		% Increase	
	Total Vehs	HGV	Total Vehs	HGV	Total Vehs	HGV
Ashby Road (north of A18)	26,611	840	13	6	0.1%	0.7%
A18 Kingsway West (west of A159)	19,668	719	77	34	0.4%	4.5%
B1216 Ferry Road West (east of New Access Rd)	5,765	1,065	1,261	558	17.9%	34.4%
M181 (north of M180)	28,187	3,531	687	323	2.4%	8.4%
M180 (W)	50,284	12,221	412	194	0.8%	1.6%
M181 (E)	40,023	9,884	275	129	0.7%	1.3%

Table 22: 2028 Operational Traffic Flows (AAWT)

Highway Link	2028 Baseline Flows		Additional Proposed Development Trips		% Increase	
	Total Vehs	HGV	Total Vehs	HGV	Total Vehs	HGV
Bellwin Drive	4,245	624	0	0	0%	0%
First Avenue (West of Bellwin Drive)	568	83	0	0	0%	0%
Stather Rd (West of New Access Rd)	0	0	124	0	100%	0%
Stather Rd (East of New Access Rd)	1,511	118	19	4	0%	0%
First Avenue (East of Bellwin Drive)	478	53	0	0	0%	0%
New Access Road	5,656	727	1,325	612	18.9%	45.7%
Stather Road (West of Neap House)	78	0	0	0	0%	0%
B1216 Ferry Rd West (West of New Access Rd)	2,758	613	0	0	0%	0%
A1077 (South of B1216))	21,597	3,312	867	415	3.9%	11.1%

Highway Link	2028 Baseline Flows		Additional Proposed Development Trips		% Increase	
	Total Vehs	HGV	Total Vehs	HGV	Total Vehs	HGV
A1077 (North of B1216)	17,322	2,439	292	161	1.7%	6.2%
Ferry Road West (east of A1077)	3,097	231	167	36	5.1%	13.4%
Holyrood Drive	7,226	223	0	0	0%	0%
Luneburg Way	9,872	223	19	4	0.2%	1.8%
A1077 (east of Luneberg Way)	20,865	2,343	273	157	1.3%	6.3%
A18 Kingsway (West)	29,905	1,910	113	54	0.4%	2.7%
A1077 (south of A18)	29,587	4,023	726	355	2.4%	8.1%
A18 Doncaster Road (west of A1077)	14,352	851	35	7	0.2%	0.8%
A159 Ashby Road (south of A18)	20,313	953	13	6	0.1%	0.5%
A18 Queensway (east of A159)	26,931	1,103	54	25	0.2%	2.2%
Ashby Road (north of A18)	28,368	1,105	13	6	0.1%	0.6%
A18 Kingsway West (west of A159)	19,789	836	81	37	0.4%	4.2%
B1216 Ferry Road West (east of New Access Rd)	6,210	1,238	1,325	612	17.6%	33.1%
M181 (north of M180)	30,188	4,103	726	355	2.3%	7.9%
M180 (W)	53,853	14,201	435	213	0.8%	1.5%
M181 (E)	42,864	11,486	290	142	0.7%	1.2%

8.2.1.3 In terms of severance, the change in traffic flows is shown to be negligible on all highway links in 2028 with the exception of the B1216 Ferry Road West (east of the New Access Road), which is shown to have a small change (21.9% AADT / 21.3% AAWT change in total vehicles and 52% AADT / 49.4% AAWT change in HGVs).

8.2.1.4 The 2028 future baseline traffic flows on the B1216 Ferry Road West including development traffic are well within the road's theoretical capacity and its adjoining junctions. Therefore, the impact is not considered to be significant.

8.2.1.5 The effect on severance for all highway links will therefore be negligible.

8.2.1.6 In terms of driver delay, the change in total vehicles is shown to be negligible on all highway links in 2028 with the exception of the following:

- New Access Road = Large Change (19.2% AADT / 18.9% AAWT)
- Ferry Road West (east of New Access Rd) = Large Change (17.9% AADT / 17.6% AAWT)
- Ferry Road West (east of A1077) = Medium Change (5.4% AADT / 5.1% AAWT)
- A1077 (south of B1216) = Small Change (4.1% AADT / 3.9% AAWT)
- A1077 (south of A18) = Small Change (2.4% AADT / 2.4% AAWT)
- M181 (north of M180) = Small Change (2.4% AADT / 2.3% AAWT)

8.2.1.7 Whilst the change in traffic on the B1216 Ferry Road West (east of the New Access Rd) and the New Access Road are shown to be large, it is considered that this increase could be absorbed satisfactorily within the theoretical capacity of these highway links and its adjoining junctions. It is considered therefore that this will result in an adverse effect of minor significance to driver delay.

8.2.1.8 Similarly, the change in traffic on Ferry Road West (east of A1077) will result in an adverse effect of minor significance to driver delay. The effect on driver delay for the remaining highway links will be negligible.

8.2.2 Pedestrians and Cyclists

8.2.2.1 The total impact on the pedestrian network is the sum of those that walk as their main mode of transport to/from the Project plus those using public transport, as walking will make up the final mode of their journey to and from the Project.

8.2.2.2 The increase in walking trips for the Project is shown in Table 23.

Table 23: Increase in Walking Trips

Mode	AM Highway Peak Hour		PM Highway Peak Hour		Daily	
	IN	OUT	IN	OUT	IN	OUT
Walk (Main Mode)	0	0	0	0	6	6
Walk (Public Transport)	1	0	0	0	12	12
Total	1	0	0	0	18	18

8.2.2.3 The net increase in cycling trips is shown below in Table 24.

Table 24: Increase in Cycling Trips

Mode	AM Highway Peak Hour		PM Highway Peak Hour		Daily	
	IN	OUT	IN	OUT	IN	OUT
Cycling	0	0	0	0	8	8

8.2.2.4 The following highway links are shown to have a two-way flow greater than 1,400 vehicles per hour in the 2028 future baseline scenario:

- A1077 – South of B1216 (Low);
- A1077 – North of B1216 (Low);
- A1077 – west of Luneburg Way (Low);
- A18 Kingsway West (Low);
- A1077 south of A18 (Low);
- A159 Ashby Road south of A18 (Low);
- A18 Queensway east of A159 (Low);
- Ashby Road north of A18 (Low);
- A18 Kingsway west of A159 (Low);
- M181 north of M180 (Low);
- M180 W (Low); and
- M181 E (Low).

8.2.2.5 All of these highway links form primary/strategic routes in and around the Scunthorpe area where traffic flows are high and there is no pedestrian/cycle infrastructure provided. Pedestrian/cycle amenity and delay is therefore unlikely to be a significant factor on these highway links.

8.2.2.6 Similarly, all other highway links with traffic flows below the threshold adopted for assessment, indicate that pedestrian/cycle amenity and delay is unlikely to be a significant factor.

8.2.2.7 Given that the increase in pedestrian/cycle movements as a result of the Project are small, the magnitude of change is predicted to be negligible and thus, the significance of the effect is expected to be negligible.

8.2.3 Highway Safety

8.2.3.1 The existing highway network within the study area does not have a significant personal injury collision record. The clusters of collisions identified have been shown to have no prevalent cause, with a variety of contributing factors.

8.2.3.2 It is considered that the additional traffic generated by the Project would not have a significant adverse impact on highway safety. The highway improvements proposed in the vicinity of the Project, including improved accessibility for pedestrians and cyclists, will likely change how the highway performs in road safety terms and may also change current collision patterns. This would be taken up as part of the Road Safety Audit procedures undertaken during the detailed design stage for the new and amended highway infrastructure.

8.2.4 Public Transport

8.2.4.1 The public transport trips generated by the Project are discussed in detail in the TA at Appendix B.

8.2.4.2 As part of the Project, existing Bus Route 60 will be diverted from Stather Road to the New Access Road, but this is unlikely to have a significant impact on bus journey times and/or bus users in this area. Therefore, there are no material changes to consider as part of this traffic and transport chapter in relation to public transport.

8.2.5 Freight Transport by River

8.2.5.1 The preliminary Navigation Risk Assessment (NRA) at Annex 6 of the ES (**Document Reference 6.3.6**) has assessed the level of service and level of safety for vessels on the River Trent.

8.2.5.2 Vessel movements expected during the operational phase (in addition to baseline traffic) are described below according to the proposed river activities anticipated as part of the Project:

- Offloading of containerised waste (RDF): approximately 350 vessel movements per year (based on 24% of import of RDF via the river).
- Loading of empty containers: Same vessels as the ones bringing containers.
- Offloading of bulk materials, primarily aggregate for construction of concrete blocks: approximately 180 vessel movements per year.
- Loading of Carbon dioxide (CO₂): approximately 50 vessel movements per year.

8.2.5.3 The combination of all the new activities would result in 580 additional vessel movements at Flixborough Wharf per year, nearly 50 additional vessel

movements per month. This represents a significant increase of nearly 200% at Flixborough Wharf (compared to the 305 movements in 2019).

8.2.5.4 Based on the capacity assessment presented in the preliminary Navigation Risk Assessment at Annex 6 of the ES (**Document Reference 6.3.6**), the increase of vessel movements during the operational phase can be accommodated at Flixborough Wharf within the existing two berths available.

8.2.5.5 However, some changes may be required in terms of handling operations (loading/ offloading materials), so that vessel rotation can be made quicker to enable vessels to leave within one day. Operating hours might also need to be extended from 12hr to 24hr during peak periods to accommodate the higher demand and increased vessel capacity.

8.2.5.6 The NRA at Annex 6 of the ES (**Document Reference 6.3.6**) identifies that the additional movements that would be associated with the Project would have a Negligible impact upon navigational safety on the River Trent with all hazards remaining at as Low as Reasonably Practicable (ALARP) or Low Risk levels with existing risk controls in place. The impact would therefore be not significant.

8.2.5.7 The increase in vessel movements and their effects has been considered further in the Air Quality and Noise assessments in Chapter 5 (**Document Reference 6.2.5**) and Chapter 7 (**Document Reference 6.2.7**). It is not considered necessary to assess transport impacts from marine movements beyond this as part of this Traffic and Transport Chapter.

8.2.6 Freight Transport by Rail

8.2.6.1 As part of the Rail Operations Report (ROR) (**Document Reference 5.11**), a rail assessment has been undertaken, which sets out the maximum scale of rail operations anticipated to be involved in the event of 100% of inbound fuel being delivered by rail.

8.2.6.2 Assuming 758,376 mt per annum of fuel, and a train payload of 1,053 mt, this would equate to 720 train arrivals per annum, or 2 trains per day on 360 days per annum or 3 trains per day on 240 days per annum.

8.2.6.3 The assumptions for movement of fuel by rail to the Project are as follows:

- Traction: diesel-electric freight locomotives, typically any of Classes 56, 59, 60, 66, 69 or 70.
- Wagons: FCA or equivalent, twin-set wagons able to carry 6 x 6m length containers per twin set.
- Containers: 6m length x 2.4m wide x 2.6m high, tare weight 4.9 tonnes, payload up to 13.5 mt.
- Train length: 1 x locomotive (21.5m) plus 13 x twin wagons (each 40.5m) = 548m.

- 8.2.6.4 Trains inbound to the Project would typically arrive from the rest of the country via Scunthorpe, passing Trent Junction and the access to the branch line to Roxby Gullett and Flixborough. Once clear of Trent Junction, the locomotive would detach and run-round its train using the main line tracks, attaching to the rear of the train to draw forward to Trent Junction and the branch line.
- 8.2.6.5 Once clear of Trent Junction the train would then enter the western half of the Dragonby Sidings, which act as the exchange point between Network Rail and the Project. The eastern half of Dragonby Sidings are used by Vossloh for handling track maintenance equipment and materials. The western sidings are currently too short to accommodate the baseline train length of 548m, and it is therefore proposed to remodel the sidings to create two arrival/departure sidings specifically for use by trains to and from the Project.
- 8.2.6.6 Trains from Trent Junction would then typically be held on arrival in Dragonby Sidings, to await clearance from the Project that the branch line and railhead were cleared for the inbound train to proceed. In the event that another train is already on the railhead or branch line, the inbound train would be held in Dragonby Sidings until the outbound train has passed on the adjacent track, allowing the inbound train to then proceed to the Project.
- 8.2.6.7 The branch line through to the proposed railhead would cover a distance of c.6.5km, the train expected to travel at no more than 40km/h (25mph) and therefore taking 10 minutes to reach the southern end of the railhead clear of any internal highway crossings, at which point the rear half of the train would already be berthed in one of the two proposed handling sidings within the railhead. The train would then be split at the halfway point, the locomotive pulling the front half of the train clear of the rear half, shunting the front half back into the second of the handling sidings within the railhead, the train then being berthed with the two halves immediately adjacent to each other. Diesel-powered reachstacker cranes would then unload and reload the containers, each container placed onto a diesel-powered internal movement vehicle to shuttle to and from the power station on the internal estate road network.
- 8.2.6.8 The timing of trains to and from the Project would be determined by the Applicant, train operator, Network Rail and the fuel supplier, in order to optimise the transit times between origin(s) and destination, taking advantage of quieter periods on the surrounding national rail network.
- 8.2.6.9 The increase in rail freight movements and their effects has been considered in the Air Quality and Noise assessments in Chapter 5 (**Document Reference 6.2.5**) and 7 (**Document Reference 6.2.7**). It is not considered necessary to assess transport impacts from rail movements beyond this as part of this Traffic and Transport Chapter.

8.2.7 Climate Change and Adaptation

- 8.2.7.1 Future climate change is likely to affect climatic parameters including precipitation, temperature, wind speed, humidity and frequency of extreme weather, which is subsequently likely to lead to increased effects on transport

infrastructure in the future. However, this is not considered to materially affect the future baseline described above for traffic and transport or increase the sensitivity of receptors to impacts.

8.2.8 Summary of Operational Effects

8.2.8.1 Table 25 summarises the effects once the Project becomes operational.

Table 25: Summary of Operational Effects

Road User / Receptor	Sensitivity	Description of Effect	Magnitude of Change/Impact	Effect Significance
Pedestrians and Cyclists	High	Change in person trips/ traffic flows as a result of the Project and improvements to the public realm and cycle/pedestrian amenity/accessibility	Small	Beneficial Effect of Moderate Significance to Pedestrian / Cycle Amenity and Delay
Motorised Users on B1216 Ferry Road West (east of the New Access Rd) and the New Access Road	Medium	Change in person trips/ traffic flows as a result of the Project	Small (Severance)	Negligible Effect on Severance / Highway Safety Adverse Effect of Minor Significance to Driver Delay
Motorised Users on Ferry Road West (east of A1077)			Large (Driver Delay) - refer to Para 8.2.1.7	
Motorised Users on all other Highway Links within the study area			Negligible (Severance)	Adverse Effect of Negligible Significance
			Small (Driver Delay)	
			Negligible	Adverse Effect of Negligible Significance to Severance / Driver Delay / Highway Safety
Public Transport Users	Medium	Increase in public transport trips	Negligible	Negligible
Vessels in River Trent	Low	Movements of vessel importing construction materials	Medium Increase in Traffic	Adverse Effect of Minor Significance

9. CONCLUSIONS

9.1 Demolition and Construction

- 9.1.1.1 The assessment has demonstrated that there will be no significant effects on traffic and transport as a result of the Project during demolition and construction, assuming that the outline CLP at Appendix D and the measures contained therein are implemented (including those to be developed such as the CTMP and Construction Workers Travel Plan (CWTP)).
- 9.1.1.2 The change in traffic flows during construction would result in a temporary adverse effect of minor significance to driver delay and negligible significance on severance, highway safety and pedestrian / cycle amenity and delay.
- 9.1.1.3 The outline CLP at Appendix D will provide the mechanism for delivery of mitigation relating to all types of freight vehicles to and from the Project during construction; with the aim of improving the safety and reliability of deliveries to the Project and minimising the environmental impact. The use of river /rail modes during construction will continue to be explored during detailed logistics planning as the scheme develops, which would be favourable from an environmental perspective as it would replace a large amount of road traffic.
- 9.1.1.4 No further measures are required beyond implementation of the outline CLP from a transport perspective. The preparation and implementation of the detailed CLP as part of the construction traffic management plan (CTMP) and a construction workers travel plan (CWTP) will be secured by DCO Requirement.

9.2 Operational

- 9.2.1.1 No significant adverse effects on traffic and transport have been identified as a result of the Project.
- 9.2.1.2 In terms of non-motorised users (severance, pedestrian / cycle amenity and delay), a beneficial effect of moderate significance has been identified due to the increase in walking and cycle trips being mitigated through proposed improvements to pedestrian/cycle accessibility at the Project and surrounding area as well as to the public realm areas within the Project.
- 9.2.1.3 In terms of motorised road users (driver delay) on the B1216 Ferry Road West (east of the New Access Rd) and Ferry West Road (east of A1077), an adverse effect is predicted of minor significance due to the increase in traffic movements. The significance of the effect on all other highway links is shown to be negligible.
- 9.2.1.4 While no quantitative analysis can be undertaken to determine the overall effect of a Travel Plan, it is widely acknowledged that a successful Travel Plan for a site such as this is likely to have a beneficial effect on influencing sustainable travel modes. By encouraging employees to travel by active and sustainable modes, this would subsequently lead to a potential reduction in

vehicle trips and thus, potentially reduce the impact on the highway network. The potential use of rail and river modes to transport operational freight would also seek to reduce the number of road trips.

9.2.1.5 By encouraging employees to travel by active and sustainable modes, this would subsequently lead to a potential reduction of any impacts on the highway network.

9.2.1.6 In conclusion, there are no significant environmental effects with respect to traffic and transport during the demolition and construction works associated with the Project or once the Project is complete and operational.

10. REFERENCES

- National Networks National Policy Statement (DfT, 2014)
- Department for Transport Strategic Road Network Guidance (DfT Circular 02/2013)
- National Planning Policy Framework (MHCLG, 2019)
- Overarching National Policy Statement for Energy (DECC 2011)
- National Policy Statement for Renewable Energy Infrastructure (DECC 2011)
- National Policy Statement for Ports (DfT Jan 2012)
- North Lincolnshire Local Plan (2003)
- North Lincolnshire Local Development Framework – Core Strategy (2011)
- [REDACTED]
- Emerging North Lincolnshire Local Plan (2022 / 2023)
- IEMA Guidelines for the Environmental Assessment of Road Traffic (1993)
- Port Marine Safety Code (DfT/MCA November 2016)
- A Guide to Good Practice on Port Marine Operations, (DfT/MCA Feb 2018)

APPENDIX A FIGURES

Date: May 2022



North Lincs Green Energy Park

Title Figure 2: Sensitive Locations

Client Information

Client NGELP
BH Proj No 0046658
Date 2022-01-14
Drawn by Jeanne Watrin
Checked by Natalie Maynard
Version 1.0

Map Information

CRS EPSG 27700
CRS OSGB 1936 / British
Name National Grid
Scale 1:40405
QGIS File S:\GIS\Projects\0046658
 North Lincs Green
 Energy Park\03 Maps
 and
 Images\20210310_NLGE
 Receptors
 Map_PEIR.qgz

Legend

- ▲ Schools / Places of Education
- Listed Buildings
- ◆ Places of Worship
- Shopping / Retail Area
- Hospital
- Country Park / Recreation Area
- Order Limits

Layer Source Information

Imagery ©2021 Google. Map Data ©2021

DO NOT SCALE THIS DRAWING

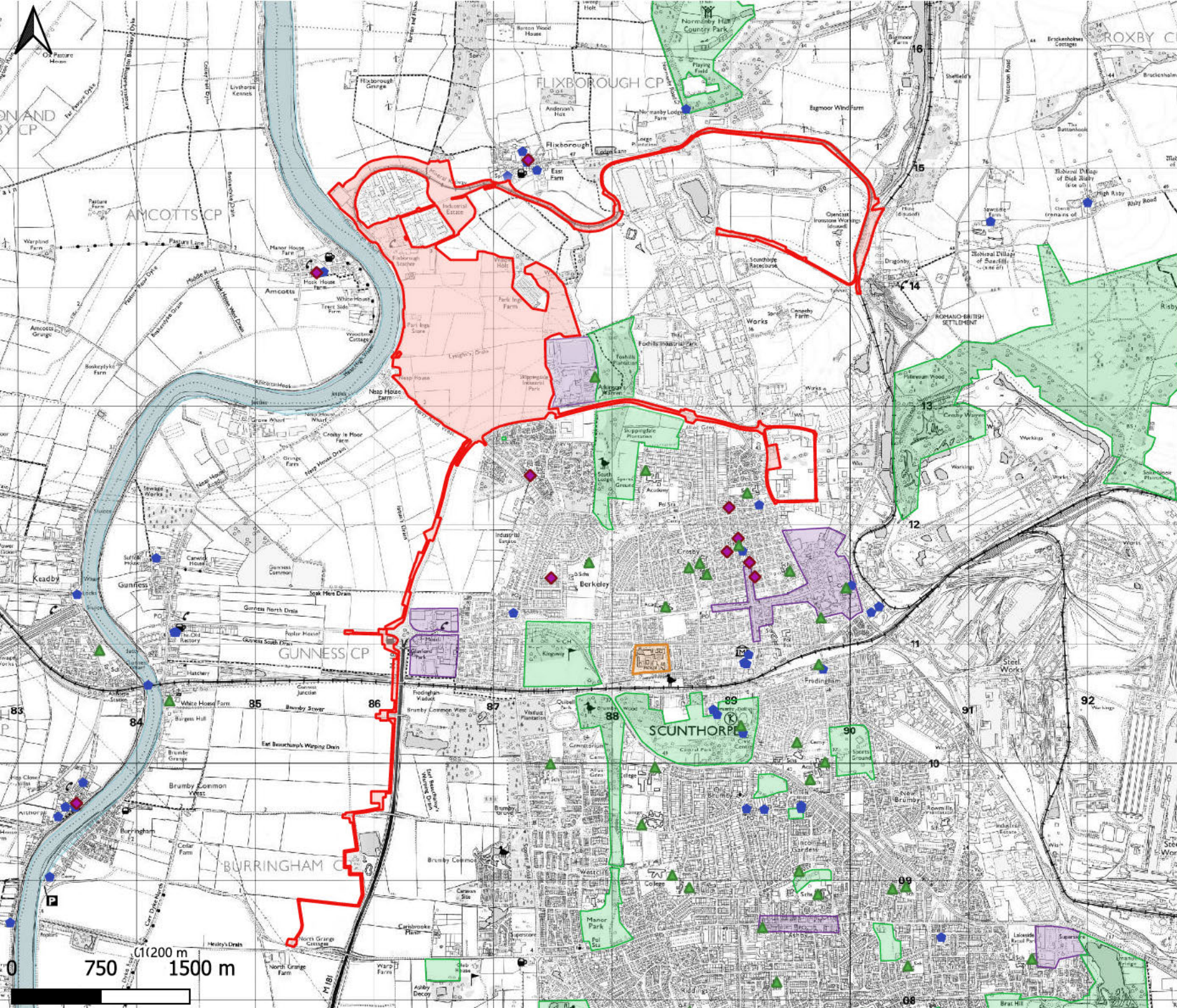

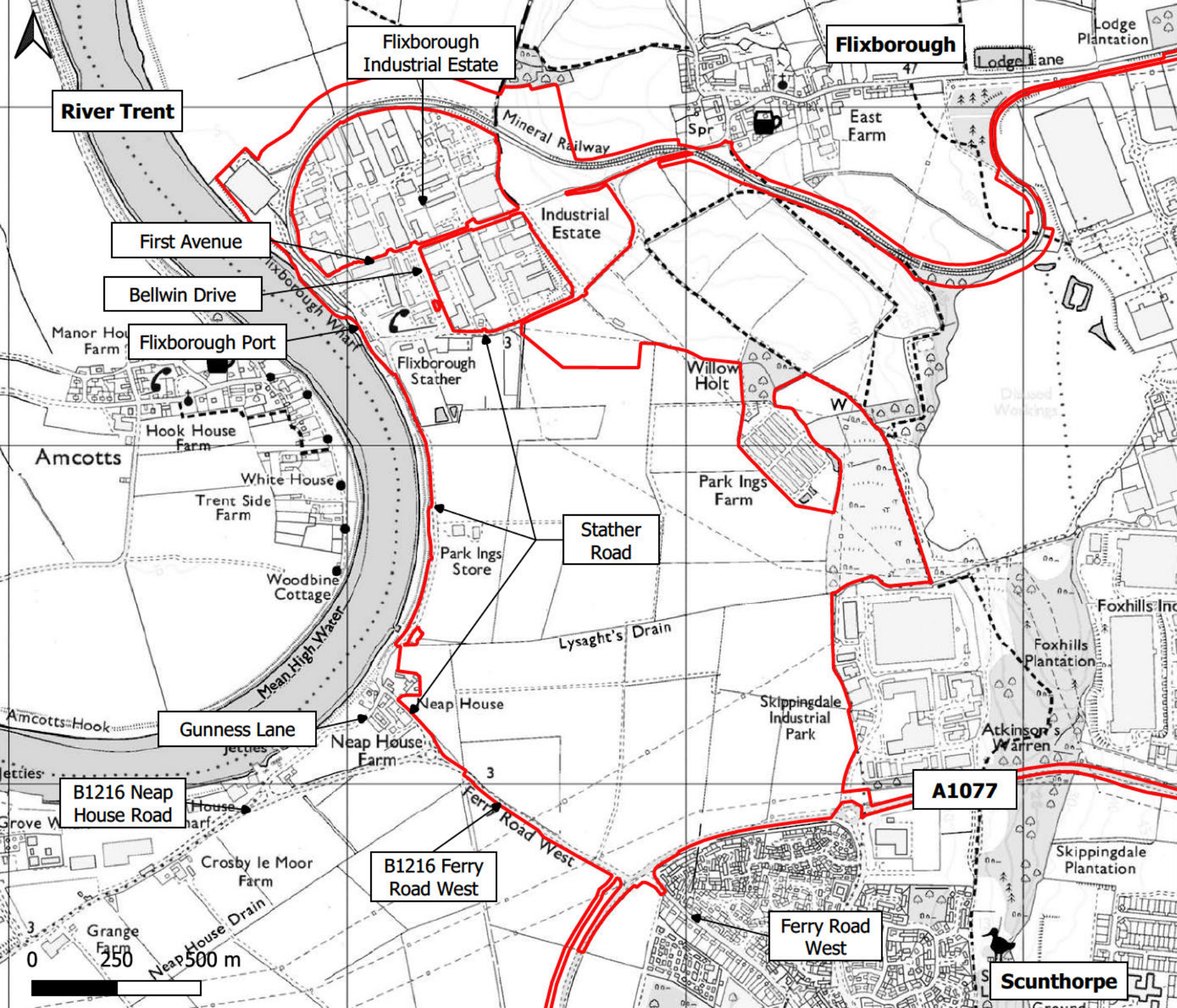

North Lincs Green Energy Park

Title Figure 3: Local Highway Network

Client Information

Client NGELP
BH Proj No 0046658
Date 2022-01-19
Drawn by Victoria Lomas
Checked by Natalie Maynard
Version 2.0

Map Information

CRS EPSG 27700
CRS OSGB 1936 / British
Name National Grid
Scale 1:14214
QGIS File
 S:\GIS\Projects\0046658 North Lincs Green Energy Park\03 Maps and Images\20210603_NLGE_P_Local Highway Network_PEIR.qgz

Legend

Order Limits

Layer Source Information

Imagery ©2021 Google. Map Data ©2021

DO NOT SCALE THIS DRAWING

North Lincolnshire Green Energy Park

Title Figure 4: Existing Pedestrian Cycling Infrastructure

Client Information

Client NGELP
BH Proj No 0046658
Date 2022-01-14
Drawn by Jeanne Watrin
Checked by Natalie Maynard
Version 2.0

Map Information

CRS EPSG 27700
CRS OSGB 1936 / British
Name National Grid
Scale 1:21213

QGIS File

S:\GIS\Projects\0046658 North Lincs Green Energy Park\03 Maps and Images\20210603_NLGE_Ped Cycle Infra_PEIR.qgz

Legend

- Existing On-road footways
- - - National Cycle Network
- Public Right of Way (PRoW)
- Order Limits

Layer Source Information

Imagery ©2021 Google. Map Data ©2021

DO NOT SCALE THIS DRAWING

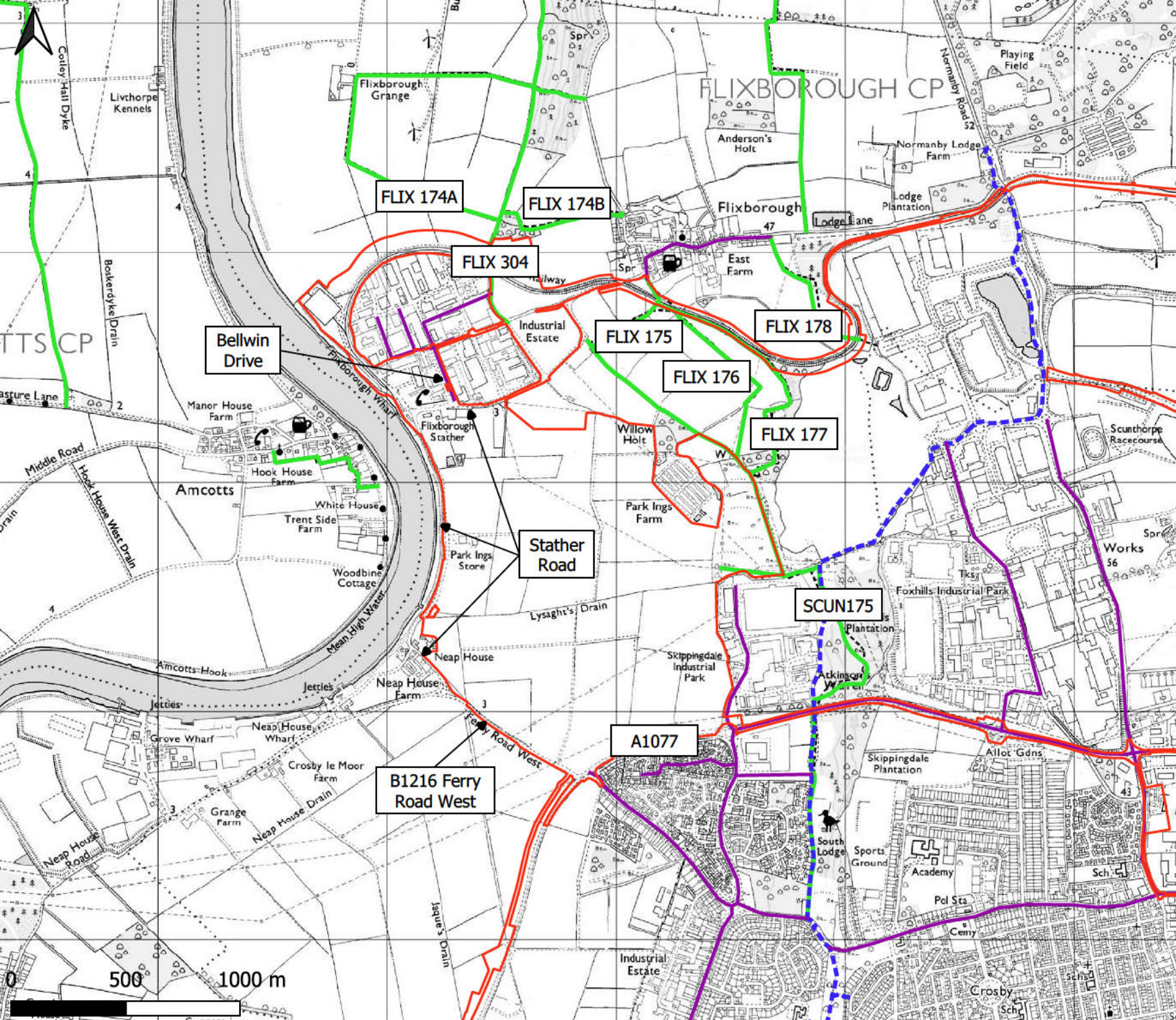

North Lincolnshire Green Energy Park

Title Figure 5: Walking Isochrones

Client Information

Client NGELP
BH Proj No 0046658
Date 2022-01-19
Drawn by Jeanne Watrin
Checked by Natalie Maynard
Version 2.0

Map Information

CRS EPSG 27700
CRS OSGB 1936 / British
Name National Grid
Scale 1:20033
QGIS File

S:\GIS\Projects\0046658 North Lincs Green Energy Park\03 Maps and Images\20210603_NLGP_Walki

Legend

- Order Limits
- 20 Minutes
- 30 Minutes

Layer Source Information

Imagery ©2021 Google. Map Data ©2021

DO NOT SCALE THIS DRAWING

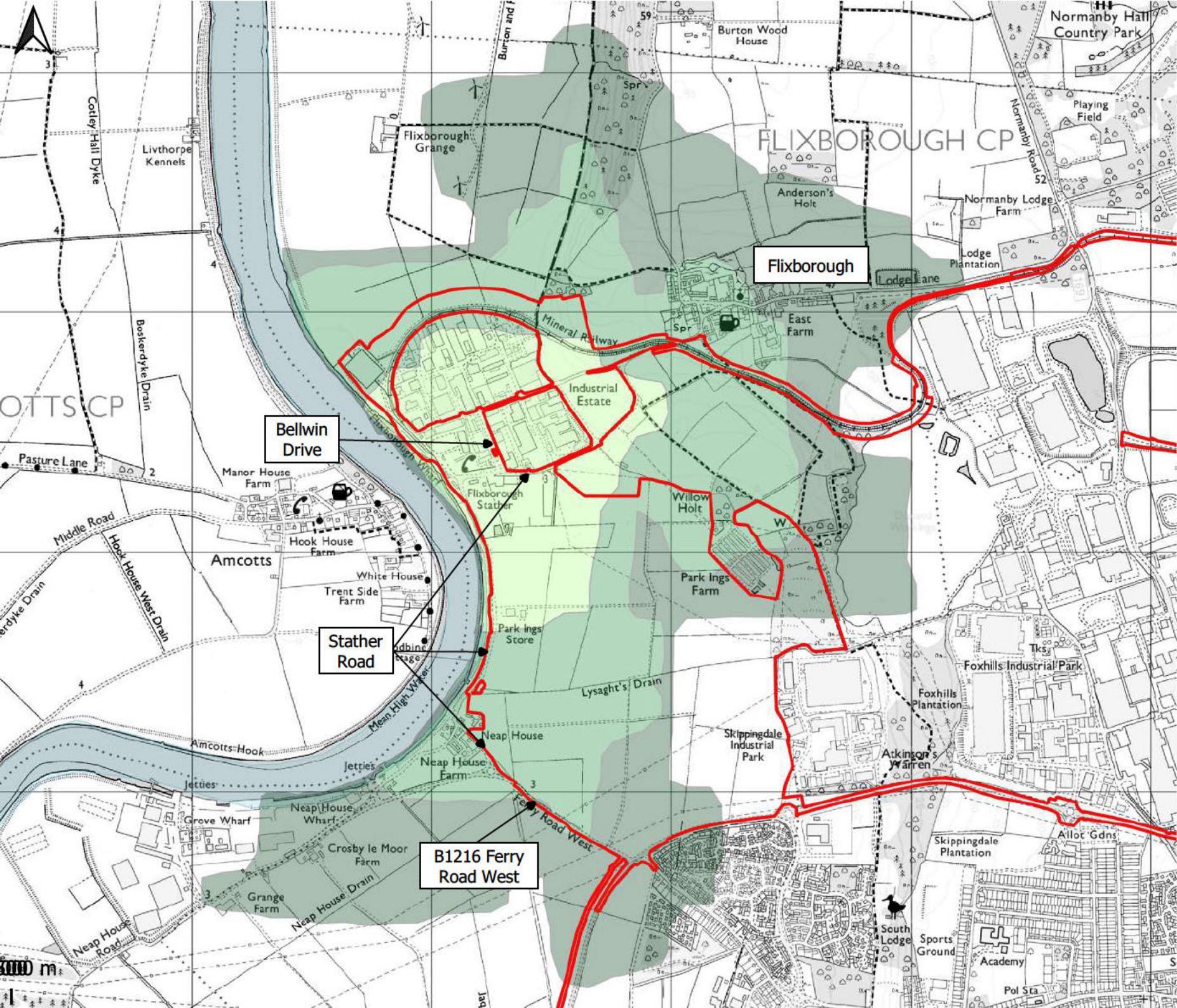

North Lincolnshire Green Energy Park

Title Figure 6: Cycling Isochrones

Client Information

Client NGELP
BH Proj No 0046658
Date 2022-01-19
Drawn by Jeanne Watrin
Checked by Natalie Maynard
Version 2.0

Map Information

CRS EPSG 27700
CRS OSGB 1936 / British
Name National Grid
Scale 1:64607
QGIS File

S:\GIS\Projects\0046658 North Lincs Green Energy Park\03 Maps and Images\20210603_NLGE_P_Walkin

Legend

- 10 Minutes
- 20 Minutes
- 30 Minutes
- Under Limits

Layer Source Information

Imagery ©2021 Google. Map Data ©2021

DO NOT SCALE THIS DRAWING

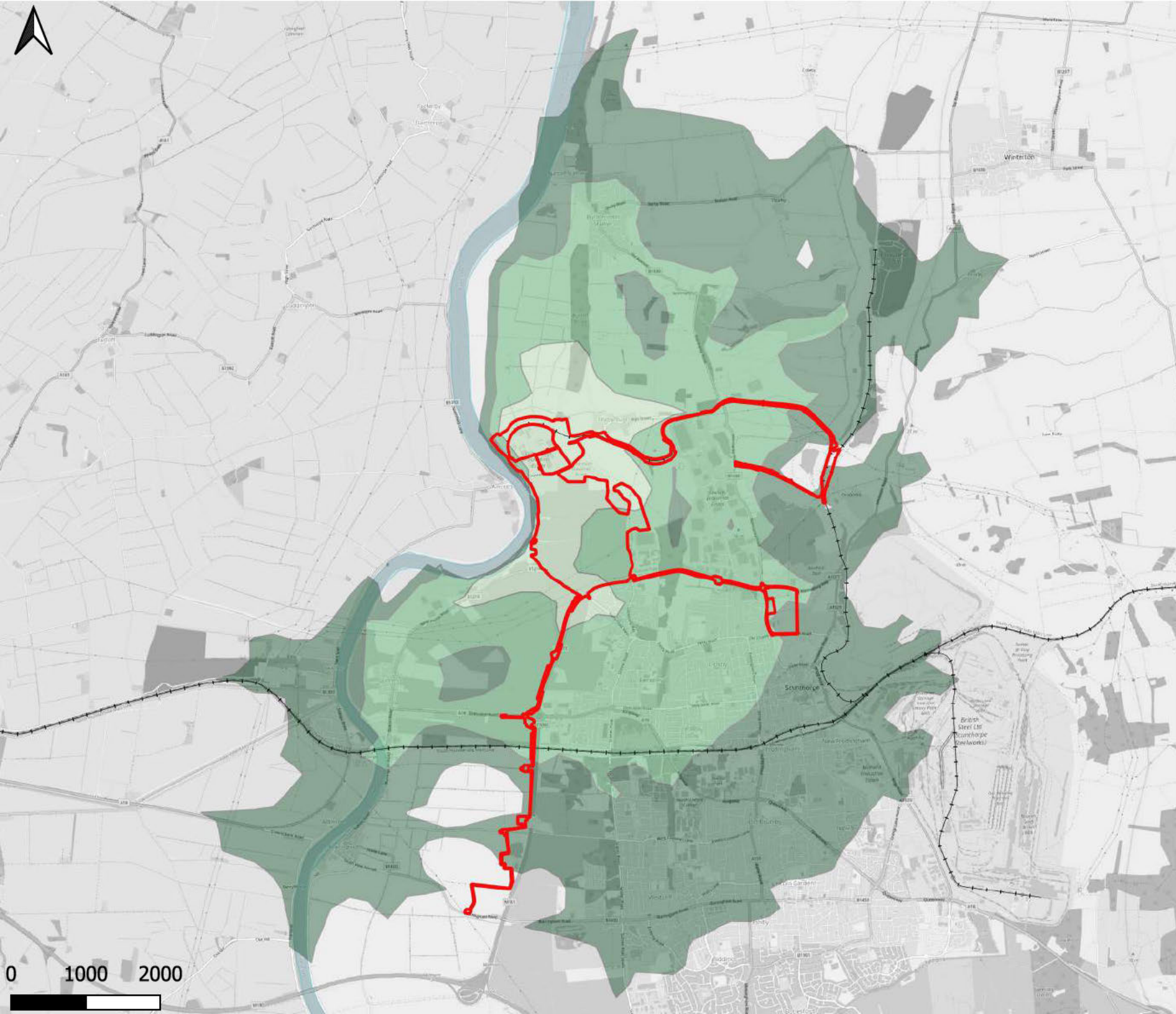

North Lincolnshire Green Energy Park

Title Figure 7: Local Freight Rail Network

Client Information

Client NGELP
BH Proj No 0046658
Date 2021-06-04
Drawn by Nick Gallop
Checked by
Version 1.2

Map Information

CRS EPSG
CRS Name
Scale Not to scale
QGIS File

Legend

- Current extent of rail network
- Historic extent of rail network
- NLGEP area of interest

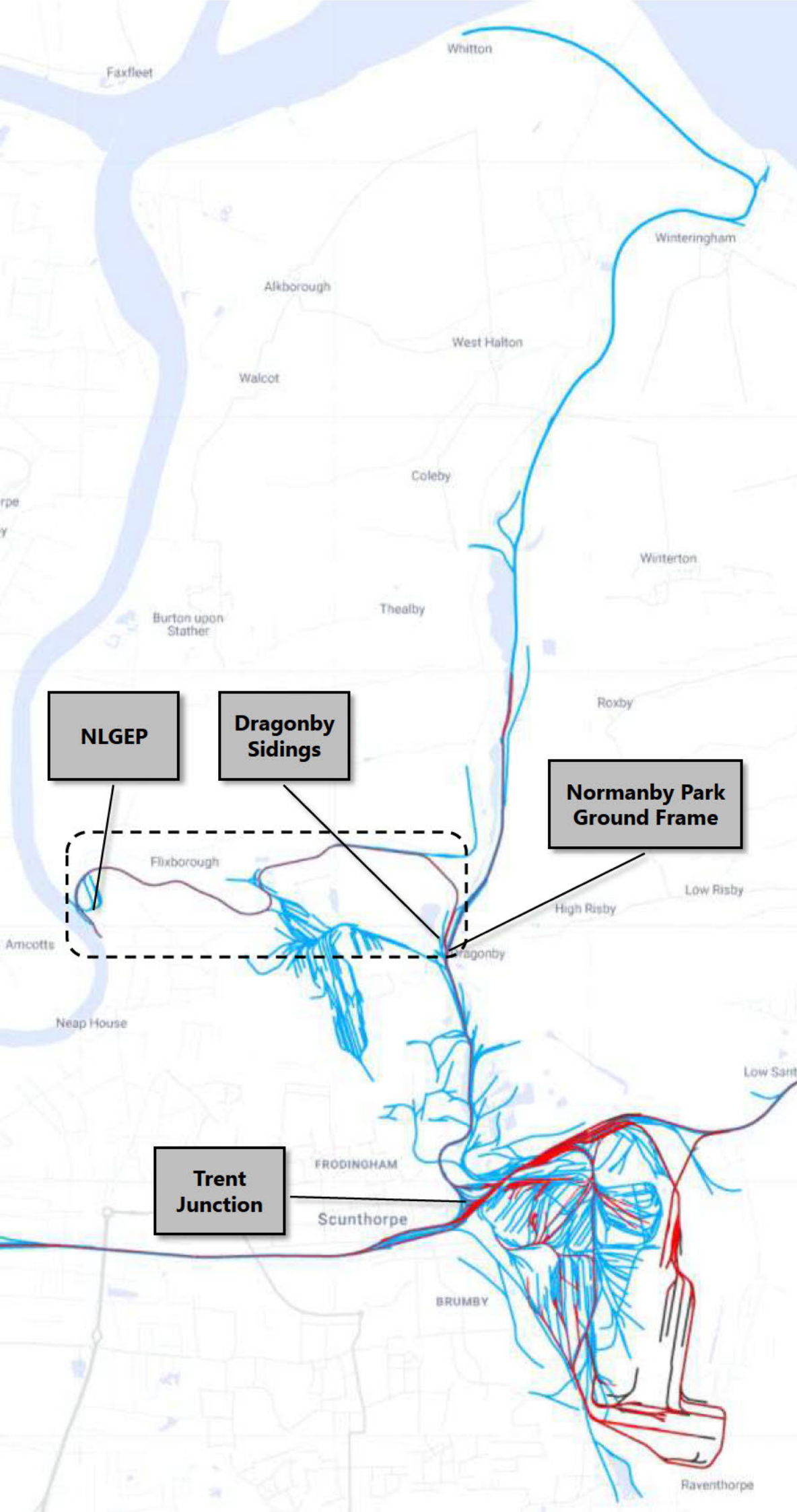

Layer Source Information

Base mapping sourced from Railmaponline.com

DO NOT SCALE THIS DRAWING

APPENDIX B TRANSPORT ASSESSMENT (TA)

Date: May 2022

North Lincolnshire Green Energy Park

Transport Assessment

0046658-TP-REP-001 P03

0046658

27 May 2022

Revision P2

Revision	Description	Issued by	Date	Checked
P0	Issued for DCO Submission	NG	14/03/22	NM
P1	Issued for DCO Submission	NM	17/05/22	NM
P2	Re-issued for DCO Submission	JW	27/05/22	NM

[REDACTED] ering/03
 Reports/Transport Assessment/046658 220527 NLGEP Transport Assessment_DCO_P2.docx

This report has been prepared for the sole benefit, use and information of North Lincolnshire Green Energy Park Limited for the purposes set out in the report or instructions commissioning it. The liability of Buro Happold Limited in respect of the information contained in the report will not extend to any third party.

author **Natalie Maynard**

date **27/05/2022**

approved **Natalie Maynard**

signature

date **27/05/22**

Contents

1	Introduction	7
1.1	Preamble	7
1.2	DCO Application Description	7
1.3	Pre-Application Consultation	10
1.4	Transport Assessment Scope	10
2	Planning Policy	12
2.1	Introduction	12
2.2	National Policy	12
2.3	Local Policy	15
3	Baseline Conditions	18
3.1	Project Location	18
3.2	Description of existing uses at the Project	19
3.3	Highway Access	20
3.4	Pedestrian and Cycle Accessibility	26
3.5	Public Transport Accessibility	29
3.6	Transport Assessment Study Area	32
3.7	Assessment of Collision Data	33
4	Baseline Traffic Flows	37
4.1	Observed Traffic Flows	37
4.2	2021 Baseline Traffic Flows	37
4.3	Stather Road Stopping Up – Traffic Re-distribution	37
4.4	Background Traffic Growth	38
4.5	Committed Developments	38
5	Proposed Development	43
5.2	Highway Access	44
5.3	Proposed Alterations to Flixborough Wharf Access	46
5.4	Pedestrian and Cycle Access	47

5.5	Coach Parking	50
5.6	Servicing and Freight Transport	51
5.7	Future TCPA Development	53
6	Trip Generation	54
6.1	Introduction	54
6.2	Employee Trips	54
6.3	Employees Modal Split	57
6.4	Employee Trip Distribution	57
6.5	Freight Transport Vehicle Trips	58
6.6	Other Operational Vehicle Trips	59
6.7	Freight Transport Vehicle Trip Distribution	60
6.8	Total Trip Generation	61
7	Transport Impact	63
7.1	Introduction	63
7.2	Pedestrian/Cycle Impact	63
7.3	Public Transport Impact	63
7.4	Highway Impact	64
7.5	Construction Impact	68
8	Mitigation Measures	70
8.1	Travel Planning	70
8.2	Walking and Cycling	70
8.3	Public Transport	71
8.4	Highways	71
8.5	Construction Traffic	72
9	Summary and Conclusions	73
9.1	Summary	73
9.2	Conclusion	76

Appendix A National Highways and NLC Scoping Consultation	
Appendix B Collision Data	
Appendix C Traffic Flow Diagrams	
Appendix D Proposed Layout Plan at the Project	
Appendix E Highway Stopping Up Plan for Stather Road	
Appendix F Proposed Highway Improvements	
Appendix G Vehicle Swept Path Analysis	
Appendix H Percentage Impact Assessment	
Appendix I LINSIG Results - A1077 / B1216 Ferry Road West Signal Junction	
Appendix J PICADY Results - Stather Road / New Access Road Priority Junction	
Appendix K ARCADY Results – B1216 Ferry West Road / New Access Road Roundabout	

Table of Tables

Table 3.1 – Bus Routes and Service Frequencies	29
Table 3.2 – Train Frequencies at Scunthorpe and Althorpe Stations	31
Table 3.3 – Collision Data Summary (Five Year period January 2016 to September 2021)	33
Table 3.4 – Number of Collisions by Junction	34
Table 4.1 – Committed Developments included in TA	39
Table 5.1 – Proposed Car and Motorcycle Parking for the core elements proposed on the Project	49
Table 5.2 – Proposed Cycle Parking at the core elements proposed on the Project	50
Table 6.1 – The Project – Total Number of Employees	54
Table 6.2 – Employee Mode Split	57
Table 6.3 – Electric Vehicle and Hydrogen Refuelling Station Trip Generation	60
Table 6.4 – Total Person Trips - Daily	61
Table 6.5 – Total Vehicle Trips	62
Table 7.1 – Pedestrian / Cycle Trips	63
Table 7.2 – Public Transport Trips	63
Table 7.3 – Stather Road / New Access Road Priority Junction - PICADY Results	66
Table 7.4 – B1216 Ferry Road West /New Access Road Roundabout - ARCADY Results	67
Table 7.5 - Peak Construction Traffic by Year	68

Table of Figures

Figure 1.1 – Project Location Plan	9
Figure 3.1 – Project Location Plan	18
Figure 3.2 – Existing Uses in the vicinity of Flixborough Industrial Estate	19
Figure 3.3 – Local Highway Network	20
Figure 3.4 – Bellwin Drive	22
Figure 3.5 – Neap House Roundabout	23
Figure 3.6 – A1077 / B1216 Signal Junction	24
Figure 3.7 – A18 / A1077 roundabout	25
Figure 3.8 – Existing Pedestrian / Cycle Infrastructure	26
Figure 3.9 – Walking Isochrones	27
Figure 3.10 – Cycling Isochrones	28
Figure 3.11 – Transport Assessment Study Area	32
Figure 4.1 – Location of Committed Developments	40
Figure 5.1 – Proposed Highway Access	45
Figure 5.2 – Proposed Pedestrian / Cycle Access	48
Figure 6.1 – Total Employees at the core elements proposed at the Project	56
Figure 6.2 – Employee Trip Distribution	58
Figure 6.3 – HGV Distribution	61
Figure 7.1 – Principal Construction HGV Access Routes	69

1 Introduction

1.1 Preamble

- 1.1.1 Buro Happold has been appointed by North Lincolnshire Green Energy Park Limited (the Applicant), to provide transportation and highways advice in relation to North Lincolnshire Green Energy Park (NLGEP) (the Project) in Flixborough, North Lincolnshire.
- 1.1.2 The proposals comprise a Nationally Significant Infrastructure Project (NSIP), which requires a Development Consent Order (DCO) application to be submitted for approval by the Planning Inspectorate (PINS) on behalf of the Secretary of State.
- 1.1.3 This Transport Assessment (TA) has been submitted in support of the DCO application and assesses the transportation impacts of the proposed development. It forms part of a suite of technical documents that have been submitted with the DCO application, including the Environmental Statement (ES), outline Construction Logistics Plan (CLP) and a Travel Plan (TP).

1.2 DCO Application Description

- 1.2.1 The North Lincolnshire Green Energy Park (NLGEP) ('the Project'), located at Flixborough, North Lincolnshire, is a Nationally Significant Infrastructure Project (NSIP) with an Energy Recovery Facility (ERF) capable of converting up to 760,000 tonnes of non-recyclable waste into 95 MW of electricity at its heart and a carbon capture, utilisation and storage (CCUS) facility which will treat the excess gases released from the ERF to remove and store carbon dioxide (CO₂) prior to emission into the atmosphere.
- 1.2.2 The NSIP incorporates a switchyard, to ensure that the power created can be exported to the National Grid or to local businesses, and a water treatment facility, to take water from the mains supply or recycled process water to remove impurities and make it suitable for use in the boilers, the CCUS facility, concrete block manufacture, hydrogen production and the maintenance of the water levels in the wetland area.
- 1.2.3 The Project will include the following Associated Development to support the operation of the NSIP:
- a bottom ash and flue gas residue handling and treatment facility (RHTF)
 - a concrete block manufacturing facility (CBMF)
 - a plastic recycling facility (PRF)

- a hydrogen production and storage facility
- an electric vehicle (EV) and hydrogen (H₂) refuelling station
- battery storage
- a hydrogen and natural gas above ground installation (AGI)
- a new access road and parking
- a gatehouse and visitor centre with elevated walkway
- railway reinstatement works including, sidings at Dragonby, reinstatement and safety improvements to the 6km private railway spur, and the construction of a new railhead with sidings south of Flixborough Wharf
- a northern and southern district heating and private wire network (DHPWN)
- habitat creation, landscaping and ecological mitigation, including green infrastructure and 65-acre wetland area
- new public rights of way and cycle ways including footbridges
- Sustainable Drainage Systems (SuDS) and flood defence, and
- utility constructions and diversions.

1.2.4 The Project will also include development in connection with the above works such as security gates, fencing, boundary treatment, lighting, hard and soft landscaping, surface and foul water treatment and drainage systems and CCTV.

1.2.5 The limits of the land covered by the DCO ('the Order Limits') is shown on Figure 1.1. The land within the Order Limits is known as the 'Application Land'. Figure 1.1 also shows the main buildings of the Project located north of the B1216 Ferry Road West (collectively known as 'the Project' including the ERF; carbon capture, utilisation and storage facility; bottom ash and flue gas residue handling and treatment facility; concrete block manufacturing facility; plastic recycling facility; hydrogen production and storage facility; electric vehicle (EV) and hydrogen (H₂) refuelling station; battery storage and hydrogen and natural gas above ground installations.

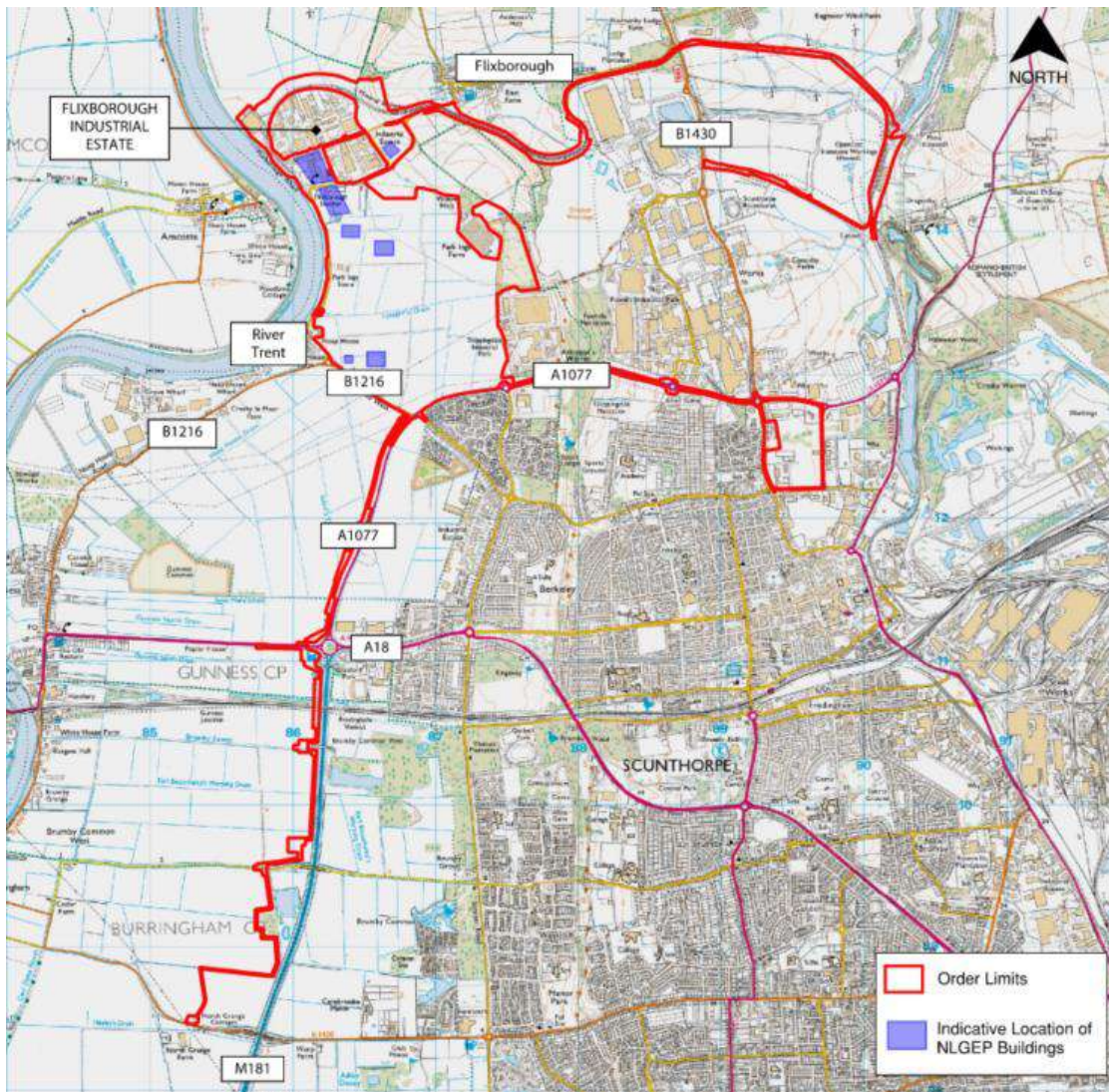

Figure 1.1 – Project Location Plan

- 1.2.6 The proposed ERF is located on land within and to the south of Flixborough Industrial Estate, which is approximately 6km north-west of Scunthorpe. The Order Limits encompasses an area within and adjacent to Flixborough Wharf (RMS Trent Ports) on the east bank of the River Trent.
- 1.2.7 Flixborough Wharf and Flixborough Industrial Estate together form an industrial complex that has supported a range of businesses and industrial activities since the early 1900s. Existing infrastructure includes roads, a rail spur, a 155m long wharf, weigh bridge, cranes, warehousing and stock sheds, workshops and portable offices.

1.3 Pre-Application Consultation

- 1.3.1 Prior to submitting the DCO application, the Applicant carried out statutory consultations in relation to the proposals (DCO pre-application consultation process), which included submission of a Preliminary Environmental Information Report (PEIR) in June 2021.
- 1.3.2 A Stakeholder Consultation Summary Report (**Document Reference 7.1**) has been submitted as part of the DCO application, which summarises the feedback received during this consultation process, and how the DCO application has taken this into account.
- 1.3.3 Separate pre-application consultation has also been undertaken with the local highway authorities in relation to the scope of this TA. This included North Lincolnshire County Council (NLC), who are the highway authority responsible for the local highway network, and National Highways (formerly Highways England), the highway authority responsible for the strategic highway network (including the M180 and M181).
- 1.3.4 A TA Scoping Report was submitted to NLC and National Highways (NH) in November 2020 and subsequent meetings and telephone discussions took place between December 2020 and March 2021. A copy of their TA Scoping Response and key scoping correspondence is included in Appendix A.

1.4 Transport Assessment Scope

- 1.4.1 The scope of the TA reflects the output of the pre-application consultation process.
- 1.4.2 The TA has been prepared in accordance with relevant policy requirements and current national best practice guidance and toolkits. The chapters of this TA are structured as follows:
- **Planning Policy** – the relevant National, Regional and Local Policy has been reviewed.
 - **Baseline Conditions** – this section outlines the existing transport baseline conditions with regard to the pedestrian and cycle networks, public transport facilities and the highway network. An analysis of collisions occurring in the vicinity of the Project over the last five years has also been undertaken.
 - **Baseline Traffic Flows** – this section describes the baseline traffic flow data used in the assessment and any committed developments that have been included.

- **Development Proposals** – description of development proposals including access, parking and provision for servicing / deliveries.
- **Trip Generation** – sets out the multimodal trip generation assessment for the proposed development including walking, cycling, public transport, vehicular and servicing.
- **Transport Impacts** – an assessment of the impacts of the proposed development, including the construction impacts, and on all modes of transport during operation.
- **Mitigation Measures** – description of the proposed measures to mitigate any anticipated transport impacts of the development during operation and construction, and
- **Summary and Conclusions**

1.4.3 In terms of travel behaviour changes as a result of the COVID-19 pandemic where the number of people travelling to/from their homes to work, schools and other destinations has altered, these changes have not been considered as part of this TA for robustness. The road traffic data used in this assessment is representative of pre-COVID-19 highway conditions, which gives a worst case for assessment purposes. This traffic data has been used to represent the current 2021 baseline, which has been agreed in principle with NLC and NH.

2 Planning Policy

2.1 Introduction

2.1.1 The following policy documents have been reviewed as part of this TA. These policy and guidance documents can be categorised at the national, regional and local level, and outline the planning policy framework for the proposed development. The relevant policies to this development are outlined below and will be referred to throughout this TA:

- National Networks National Policy Statement (NN NPS) (2014)
- National Planning Policy Framework (NPPF) (2021)
- Department for Transport Strategic Road Network Circular 02/2013
- North Lincolnshire Local Plan Saved Policies (2003)
- North Lincolnshire Local Development Framework – Core Strategy (June 2011); and
- Emerging North Lincolnshire Local Plan (2022 / 2023).

2.1.2 The relevant policies to this development are summarised below.

2.2 National Policy

National Networks National Policy Statement (DfT, 2014)

2.2.1 The National Networks National Policy Statement (National Networks NPS) sets out the need for, and Government's policies to deliver, development of Nationally Significant Infrastructure Projects (NSIPs) on the national road and rail networks in England.

2.2.2 The 'national road network' refers to the Strategic Road Network (SRN) which is managed by National Highways.

2.2.3 The Secretary of State will use this NPS as the primary basis for making decisions on development consent applications (DCO) for NSIPs in England.

2.2.4 The National Networks NPS provides specific transport policy for NSIPs where quite particular considerations apply. It also provides guidance on matters such as good scheme design, as well as the treatment of environmental impacts. The overall strategic aims of the National Networks NPS is consistent with the National Planning Policy Framework (NPPF 2021), which both seek to achieve sustainable development.

2.2.5 Whilst sustainable transport modes are encouraged, it is recognised in the National Networks NPS that it may not be *“realistic for public transport, walking or cycling to represent a viable alternative to the private car for all journeys, particularly in rural areas...”*.

Department for Transport Strategic Road Network Guidance (DfT Circular 02/2013)

2.2.6 DfT Circular 02/2013 ‘The Strategic Road Network and the Delivery of Sustainable Development’ sets out the way in which National Highways “will engage with communities and the development industry to deliver sustainable development and, thus, economic growth, whilst safeguarding the primary function and purpose of the strategic road network.”

2.2.7 National Highways is responsible for operating, maintaining and improving the Strategic Road Network (SRN) in England.

2.2.8 DfT Circular 02/2013 is guided by the Government’s core objective of providing ‘safe roads, reliable journeys, informed travellers’. It expects initiatives to be put forward to manage the traffic impact of the proposed development and support the promotion of sustainable transport, which would be expected to include a robust travel plan.

2.2.9 DfT Circular 02/2013 confirms that a proposed development is likely to be acceptable if it “can be accommodated within the existing capacity of the strategic road network...or does not increase demand for use of a section that is already operating at over-capacity levels, taking account of any travel plan, traffic management and/or capacity enhancement measures that may be agreed.”

2.2.10 DfT Circular 02/2013 also states that all environmental implications associated with the proposed development should be adequately assessed in accordance with prevailing policies and standards. This requirement applies to the environmental impacts arising from the temporary construction works as well as the permanent / operational situation.

National Planning Policy Framework (MHCLG, 2021)

2.2.11 The National Planning Policy Framework (NPPF 2021) revised by Ministry of Housing, Communities & Local Government (MHCLG) in July 2021 sets out the government’s planning policies for England and how these are expected to be applied. It emphasises the importance of the transport policy in facilitating sustainable development.

2.2.12 The NPPF is a relevant consideration in decisions on NSIPs.

2.2.13 The NPPF sets out the Government's planning policies for non NSIPs in England and how these are expected to be applied.

2.2.14 The National Planning Policy Framework (NPPF 2021) was originally published by Ministry of Housing, Communities & Local Government (MHCLG) in March 2012 and was last updated in June 2019.

2.2.15 Section 9 of the NPPF (Paras. 104 to 113) sets out the approach for promoting sustainable transport. It requires that all development generating significant amounts of movement should be supported by a Transport Assessment (TA) so that the impacts of the proposal on the transport network and environment can be adequately assessed (Para. 113). It also suggests that transport should be considered at the earliest stages of development proposals (Para. 104) so that:

- "Opportunities to promote walking, cycling and public transport use are identified and pursued; and
- Patterns of movement, streets, parking and other transport considerations are integral to the design of schemes and contribute to making high quality places."

2.2.16 When considering development proposals, the NPPF recommends that applications ensure that:

- "appropriate opportunities to promote sustainable transport modes can be – or have been – taken up, given the type of development and its location
- safe and suitable access to the Site can be achieved for all users; and
- any significant impacts from the development on the transport network (in term of capacity and congestion), or on highway safety, can be cost effectively mitigated to an acceptable degree."

2.2.17 Paragraph 111 states that development 'should only be prevented or refused on highways grounds if the residual cumulative impacts on the road network or road safety would be severe.'

2.2.18 Paragraph 112 states that applications for development should:

- "give priority first to pedestrian and cycle movements, both within the scheme and with neighbouring areas; and second – so far as possible – to facilitating access to high quality public transport, with layouts that maximise the catchment area for bus or other public transport services, and appropriate facilities that encourage public transport use
- address the needs of people with disabilities and reduced mobility in relation to all modes of transport

- create places that are safe, secure and attractive – which minimise the scope for conflicts between pedestrians, cyclists and vehicles, avoid unnecessary street clutter, and respond to local character and design standards
- allow for the efficient delivery of goods, and access by service and emergency vehicles; and
- be designed to enable charging of plug-in and other ultra-low emission vehicles in safe, accessible and convenient locations.”

2.3 Local Policy

North Lincolnshire Local Plan (2003)

- 2.3.1 The Project is located within the administrative district of North Lincolnshire Council, which is a unitary authority.
- 2.3.2 The North Lincolnshire Local Plan (adopted in May 2003) has been replaced by the Local Development Framework (discussed later in this section) but most policies from this Local Plan have been saved including the key transport-related policies summarised below:

T1 Location of Development: Development will be encouraged to locate in principal settlements where they *“are easily accessible by foot, cycle and public transport”* and where development involves significant movement of freight this should be located where *“good access is possible to rail, water and the North Lincolnshire Strategic Road Network.”*

T2 Access to Development: It is important that all development is accessible both for all modes of transport and by all users irrespective of any mobility impairment. *“It must be served adequately by public transport, cycling, walking and the existing highway network.”*

T4 Developer Contributions: Developers will be required to demonstrate that their development is adequately served by a variety of modes of transport and will not have an adverse effect on transport near the Site. Contributions will be sought through planning obligations in accordance with the advice of Circular 05/2005 - Planning Obligations.

T6 Pedestrian Routes and Footpaths: Major new developments will be required to include links to nearby existing or proposed pedestrian routes.

T7 Development of a Cycle Network: To promote cycling as a mode of transport.

T8 Cyclists and Development: New developments will be required to: i) include cycle links with existing or proposed routes where such opportunity exists; and ii) ensure that the provision of cycle parking facilities is in accordance with the standards set out in Appendix B of the Local Plan.

T9 Promoting Buses and Trains: The use of buses and trains will be encouraged as an alternative to the private car.

T11 Protecting Rail Routes The existing network of rail freight / disused railway alignments will be protected from development where there is a reasonable prospect of their re-use for transport purposes.”

T14 The North Lincolnshire Strategic Road Network (NLSRN): Traffic should be channelled onto the roads in the North Lincolnshire area, which are most able to accommodate it. Inter urban traffic in this area is predominantly routed via the M180/M181.

T15 Highway Improvements and New Highway Construction: Where new highway infrastructure is being developed, a balance must be struck between restricting environmental impacts associated with construction and operation and the overall community benefits of the scheme.

T19 Car Parking Provisions & Standards: Car Parking provision should comply with the Parking Provision Guidelines set out in Appendix B of the Local Plan.

2.3.3 The Parking Provision Guidelines set out North Lincolnshire’s car and cycle parking standards for new developments based on their land use classification. Given that the proposed development does not fall within a specific use classification and is considered ‘sui generis’, an appropriate level of car parking has been provided based on the bespoke operations (discussed in detail in Section 5).

T22 Rail Freight: The use of rail for goods traffic will be encouraged.

T23 Water Freight: Water transport represents an efficient means of moving a variety of freight cargoes. There is scope for industry to capitalise on these facilities.

T24 Road Freight: North Lincolnshire Council will promote alternative means of freight movement to Heavy Good Vehicles (HGVs.) Where transporting freight by road is the only feasible option the Council will seek to develop measures to mitigate the adverse impact of these vehicles where necessary.

North Lincolnshire Local Development Framework – Core Strategy (2011)

2.3.4 This Core Strategy sets out North Lincolnshire’s long-term spatial planning framework for the development of North Lincolnshire up to 2026.

- 2.3.5 North Lincolnshire's vision is to become the Global Gateway for the north of England. Whilst it is their ambition to grow North Lincolnshire, the main priority is to ensure that all developments are sustainable and complement and enhance the area's high quality natural and built environment without any detrimental impact.
- 2.3.6 It also highlights North Lincolnshire's great potential to support the continued growth of renewable energy industries.

Emerging North Lincolnshire Local Plan (2022 / 2023)

- 2.3.7 North Lincolnshire Council is preparing a new Local Plan for North Lincolnshire to provide guidance for development to 2036. This new Local Plan is intended to replace the saved policies from the adopted Local Plan and the Local Development Framework. The draft new Local Plan is due to be published later this year / early 2023.

Planning for Renewable Energy Development Supplementary Planning Document (2011)

- 2.3.8 This Supplementary Planning Document (SPD) sets out North Lincolnshire Council's approach to planning for renewable energy. Policy 13 contained within this report sets out Highways and Rights of Way
- 2.3.9 Policy 13 - Developers should consider access to proposed Sites for renewable energy development from the earliest stages in putting together proposals. All proposals should be accompanied by an assessment of the full access route to the Site, which should meet the requirements of the highway authority. Where appropriate mitigation measures should be identified.

3 Baseline Conditions

3.1 Project Location

3.1.1 Figure 3.1 shows the location of the Project in the strategic context.

3.1.2 The core elements of the Project include the ERF; carbon capture, utilisation and storage facility; bottom ash and flue gas residue handling and treatment facility; concrete block manufacturing facility; plastic recycling facility; hydrogen production and storage facility; electric vehicle (EV) and hydrogen (H₂) refuelling station; battery storage and hydrogen and natural gas above ground installations (collectively known as The Project).

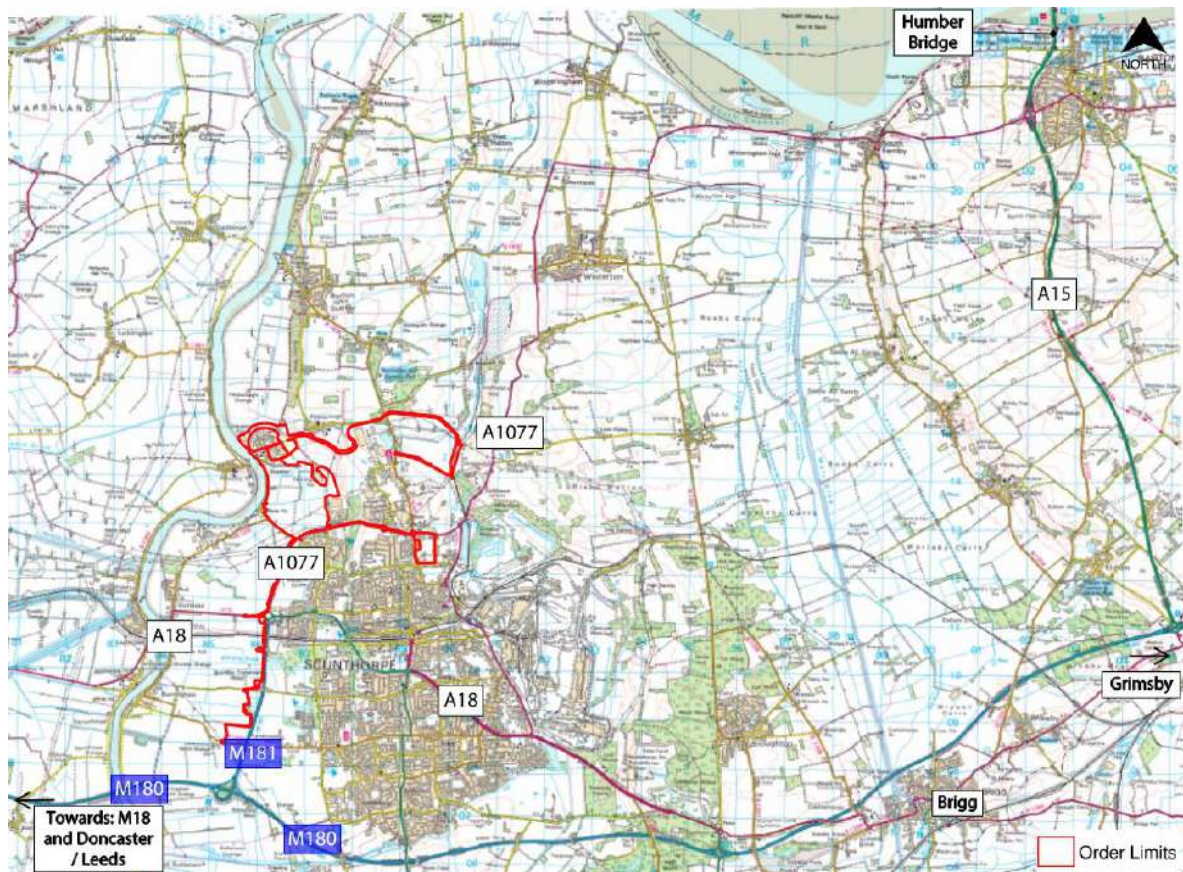

Figure 3.1 – Project Location Plan

3.1.3 The Project is situated 1.5km south-west of Flixborough Village, 6km north-west of Scunthorpe town centre and around 23km south-west of the Humber Bridge. The M181 / M180 is situated approximately 4km to the south and the A1077 is around 1.5km to the south-east.

3.1.4 The M180 connects eastwards via Brigg to Grimsby, and westwards approximately 18 kilometres to the M18, which provides onward connections to the M62 to the north and the M1 to the south via Doncaster.

3.1.5 There are additional connections to/from the north via the A1077 and the A15 Humber Bridge at Hull, which connects to the A63 and A164.

3.2 Description of existing uses at the Project

3.2.1 The Project is an area within the Order Limits, containing the core elements of the Project (ERF; carbon capture, utilisation and storage facility; bottom ash and flue gas residue handling and treatment facility; concrete block manufacturing facility; plastic recycling facility; hydrogen production and storage facility; electric vehicle (EV) and hydrogen (H₂) refuelling station; battery storage and hydrogen and natural gas above ground installations) located north of Ferry Road West (B1216).

3.2.2 The proposed ERF is located within and to the south of Flixborough Industrial Estate and Figure 3.2 shows the existing uses in this area.

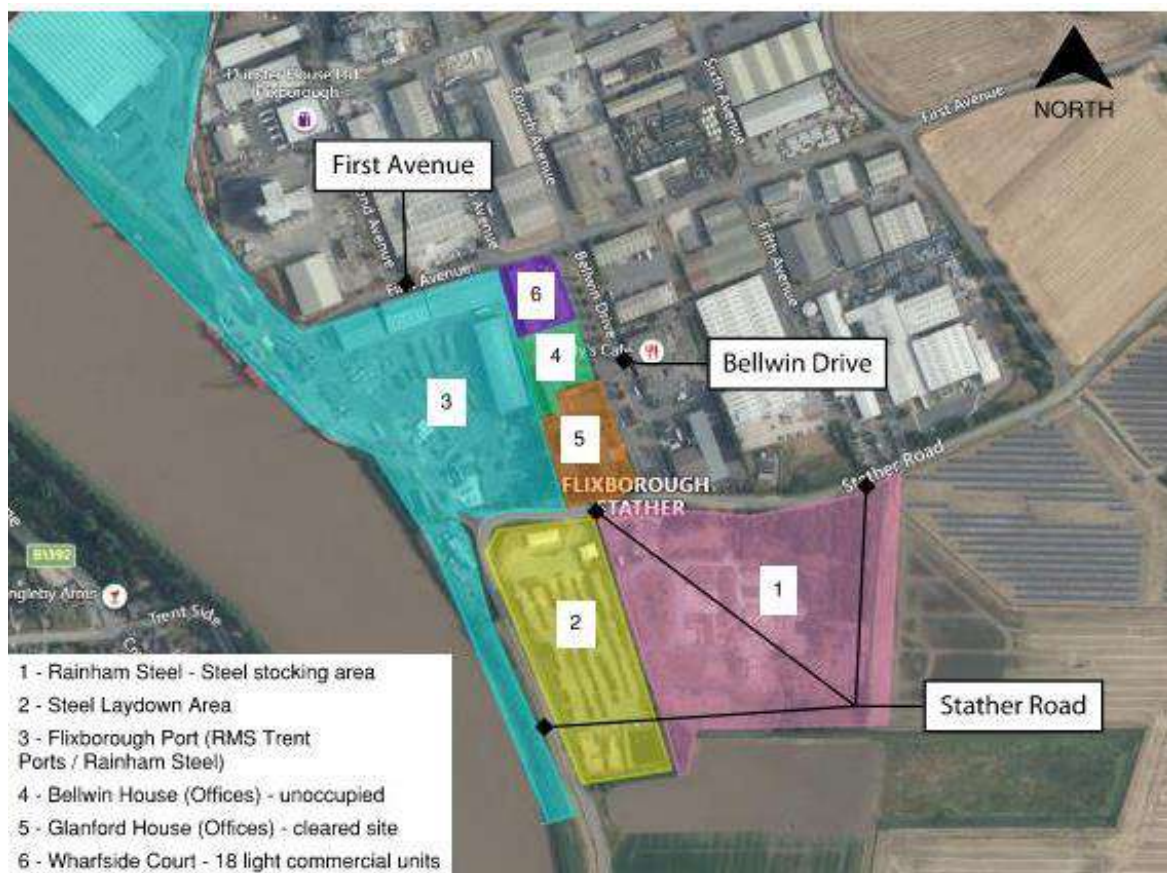

Figure 3.2 – Existing Uses in the vicinity of Flixborough Industrial Estate

3.2.3 Large industrial facilities within the wider Flixborough Industrial Estate and on adjacent land include a cement works, wind turbines, grain processing facilities, and a small power station that has a feedstock of chicken litter and bone meal.

3.3 Highway Access

3.3.1 The local highway network is shown on Figure 3.3.

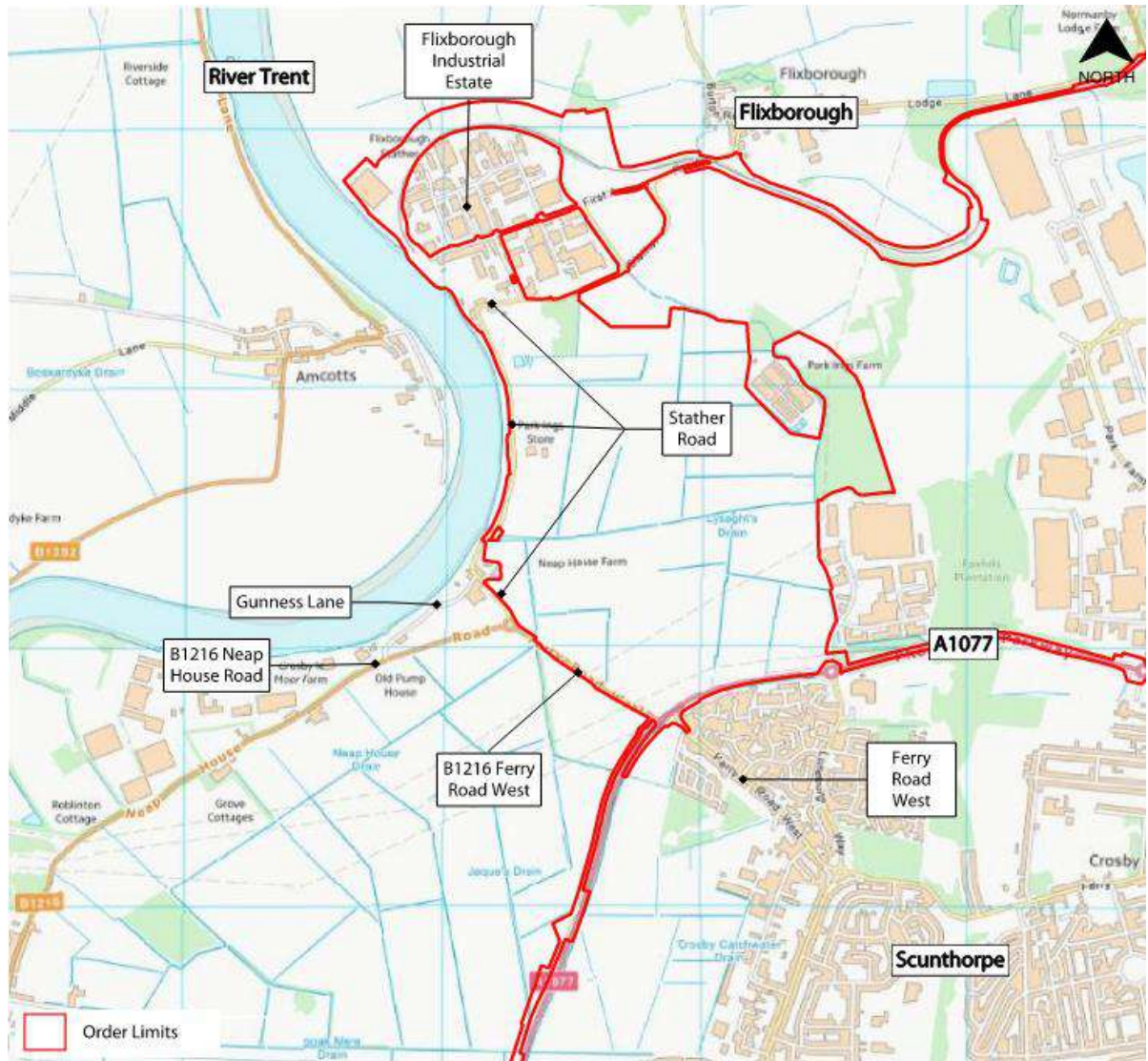

Figure 3.3 – Local Highway Network

3.3.2 Stather Road currently provides the main vehicular access route to/from Flixborough Industrial Estate and Flixborough Wharf.

- 3.3.3 HGVs currently take access to/from the south along Stather Road via Neap House and the B1216 Ferry Road West. The 7.5T weight restriction imposed along Stather Road restricts HGV access to the east via Flixborough Village.
- 3.3.4 The existing section of Stather Road via Neap House is approximately 5.3m wide making it narrow for two-way HGV movements so there are currently traffic signals provided at this location to control vehicle movements in either direction.
- 3.3.5 To the north of Neap House, Stather Road is approximately 6 metres in width with no footway provision, which continues northwards alongside the River Trent for approximately 160 metres where a water pumping station is located on the eastern side. Approximately 850 metres north of this is the main access to Flixborough Port, which forms a priority junction with Stather Road. At this location, Stather Road takes a sharp right turn continuing eastward via Flixborough Industrial Estate and then onwards towards Flixborough Village.
- 3.3.6 Lower Trent Composting Plant (now used as a steel stocking area and part of RMS Ports) is located on the south-eastern side of Stather Road with access located approximately 70 metres east of the Flixborough Port access. Bellwin Drive is located approximately 100 metres further east of this, which provides the main access point to/from Flixborough Industrial Estate.
- 3.3.7 In the vicinity of Flixborough Wharf, Stather Road is a two-way single carriageway of approximately 7 metres in width, with no existing footway provision and is subject to a speed limit of 30mph.
- 3.3.8 Bellwin Drive provides the main access to Flixborough Industrial Estate. It connects with First Avenue approximately 270 metres north of Stather Road, which runs east-west between Stather Road and Flixborough Wharf. First Avenue is approximately 900 metres in length and provides a secondary access to Flixborough Industrial Estate as well as Flixborough Wharf. Whilst there is some footway provision along First Avenue, this does not currently extend along its entire length. First Avenue is approximately 6 metres wide and subject to a speed limit of 30mph with no on street parking/loading restrictions
- 3.3.9 Bellwin Drive is a single carriageway with northbound and southbound traffic separated by a central landscaped area, and a road width of approximately 6 metres in each direction. There are 2m wide footways provided along each side of the carriageway. There is a café in the former manned gatehouse provided at its southern end, together with a U-turn facility. Bellwin Drive is subject to a 30mph speed limit with no on street parking/loading restrictions.

3.3.10 Bellwin Drive and part of First Avenue are adopted highways maintained by NLC. The section of First Avenue between Flixborough Wharf and Second Avenue is within the RMS Ports ownership.

3.3.11 Figure 3.4 shows the existing highway arrangement at Bellwin Drive.

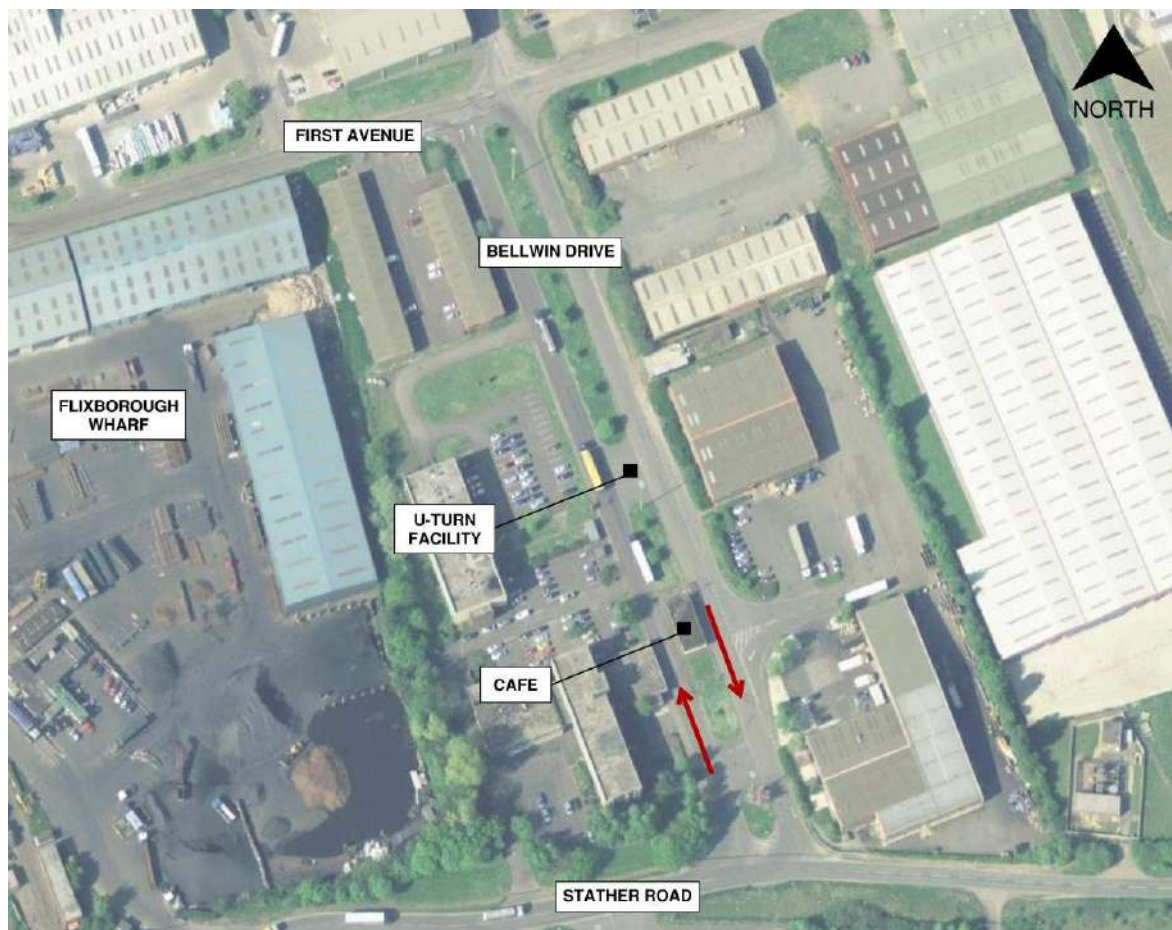

Figure 3.4 – Bellwin Drive

3.3.12 Key local highway junctions are described below.

B1216 Ferry Road West / Neap House Roundabout

3.3.13 B1216 Ferry Road West is a two-way single carriageway subject to a 50mph speed limit. It is approximately 7m wide with street lighting and runs east-west from the A1077 to Neap House Roundabout with no footways along its length. The B1216 Ferry Road West joins the A1077 in the form of a signalised staggered junction, which is described in more detail later in this section.

3.3.14 Approximately 700 metres west of this signal junction, the B1216 joins Stather Road in the form of a 3-arm roundabout, known as Neap House Roundabout. The layout of the 3-arm roundabout can be seen at Figure 3.5.



Figure 3.5 – Neap House Roundabout

A1077/B1216 Signal Junction

3.3.15 The layout of the A1077/B1216 signal junction is indicated on Figure 3.6.

3.3.16 The A1077, together with the adjoining M181, located approximately 3 kilometres further south, form part of the orbital road network around Scunthorpe. The A1077 is a two-way single carriageway subject to a 50mph speed limit. There are no pedestrian footways along its route.

3.3.17 To the north-east of the A1077/B1216 signal junction, the A1077 continues eastwards via Skippingdale Retail Park and Dragonby where it then continues northwards via Winterton towards the A15 Humber Bridge.

3.3.18 Ferry Road West, which forms the south-eastern approach to the A1077 / B1216 signal junction, is residential in nature and approximately 7 metres in width with a 2m wide footway provided along the eastern side of the carriageway. Ferry Road West provides the main pedestrian / cycle route to/from Scunthorpe and the surrounding areas.

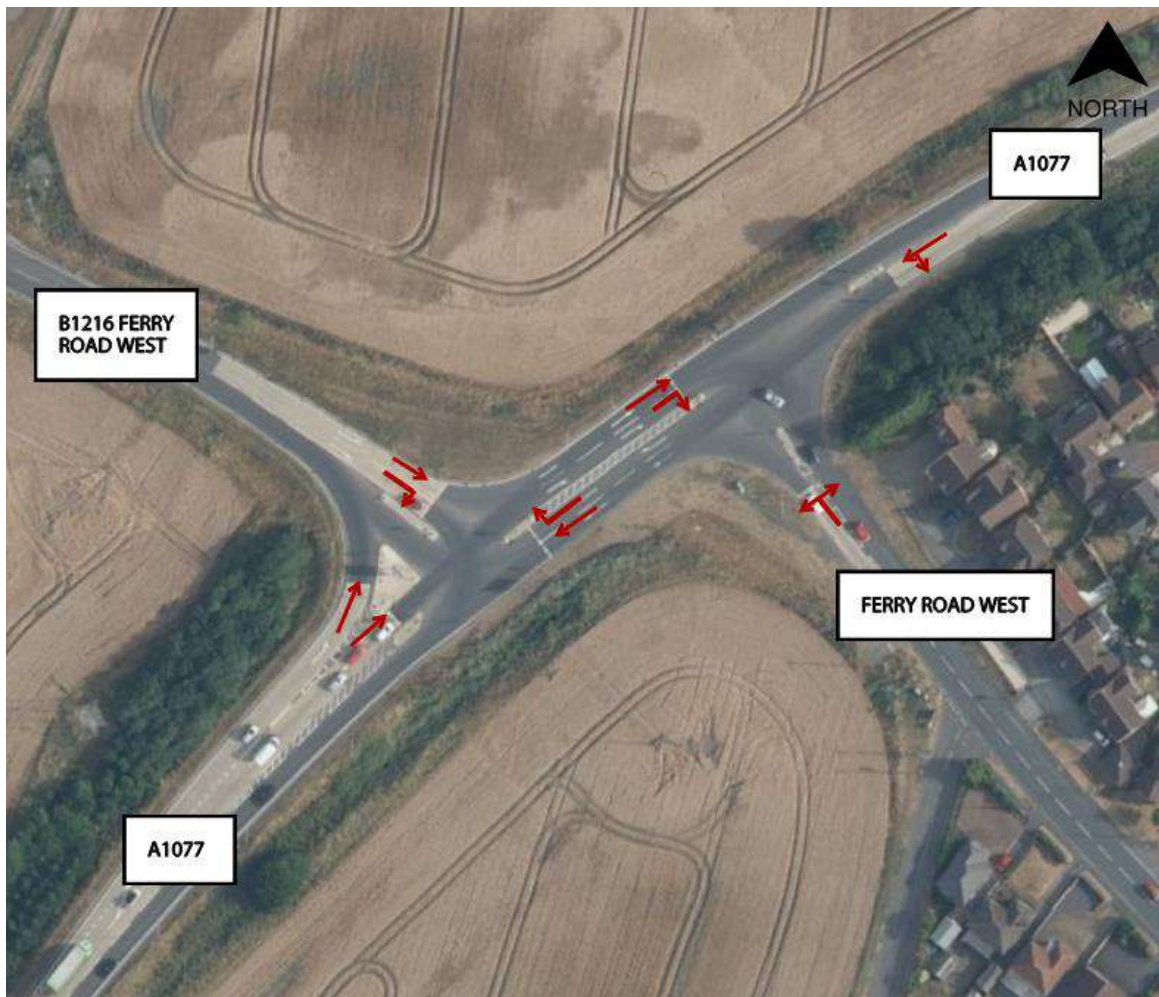

Figure 3.6 – A1077 / B1216 Signal Junction

3.3.19 Existing queue observations in October 2021 indicate that this junction operates satisfactorily with some build-up of queues during highway peak periods on the A1077 approaches with a maximum queue of around 8 to 10 Passenger Car Units (PCUs). The B1216 Ferry Road West and Ferry Road West approaches were seen to have minimal queues during peak periods.

A18 / A1077 Roundabout

3.3.20 The layout of the A18 / A1077 roundabout can be seen at Figure 3.7.

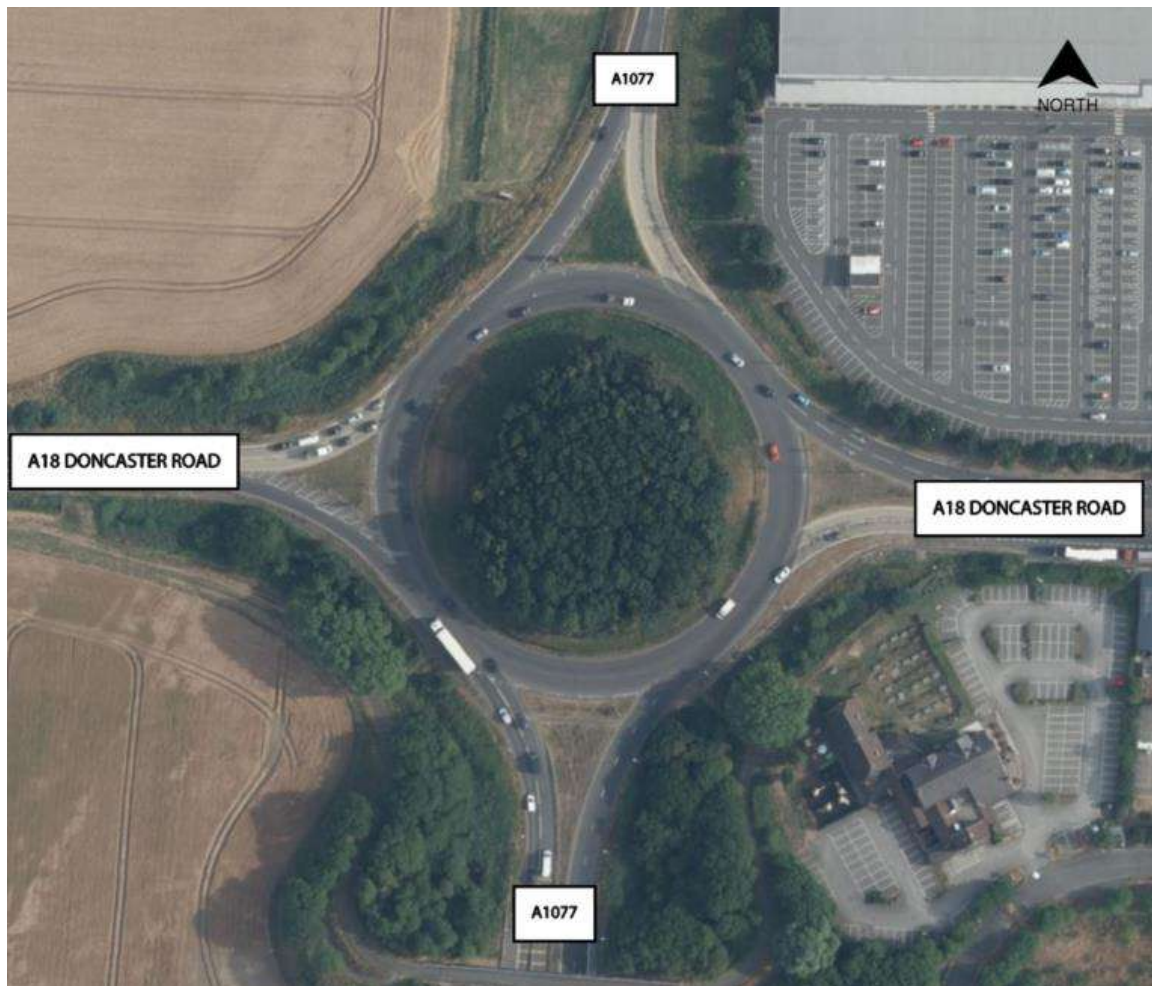

Figure 3.7 – A18 / A1077 roundabout

3.3.21 The A18 Doncaster Road is subject to a 40mph between the A18 / A1077 roundabout and A18 / Scotter Road roundabout. To the west, the A18 Doncaster Road is subject to a 60mph speed limit. Pedestrian infrastructure is present across the A1077 southern arm in the form of a pedestrian footway, which runs along the A18 west, crosses the A1077 and continues along the A18 Doncaster Road West for approximately 70m. Street lighting is present at each arm.

3.4 Pedestrian and Cycle Accessibility

3.4.1 Figure 3.8 shows the existing pedestrian and cycle infrastructure in the vicinity of the Project.

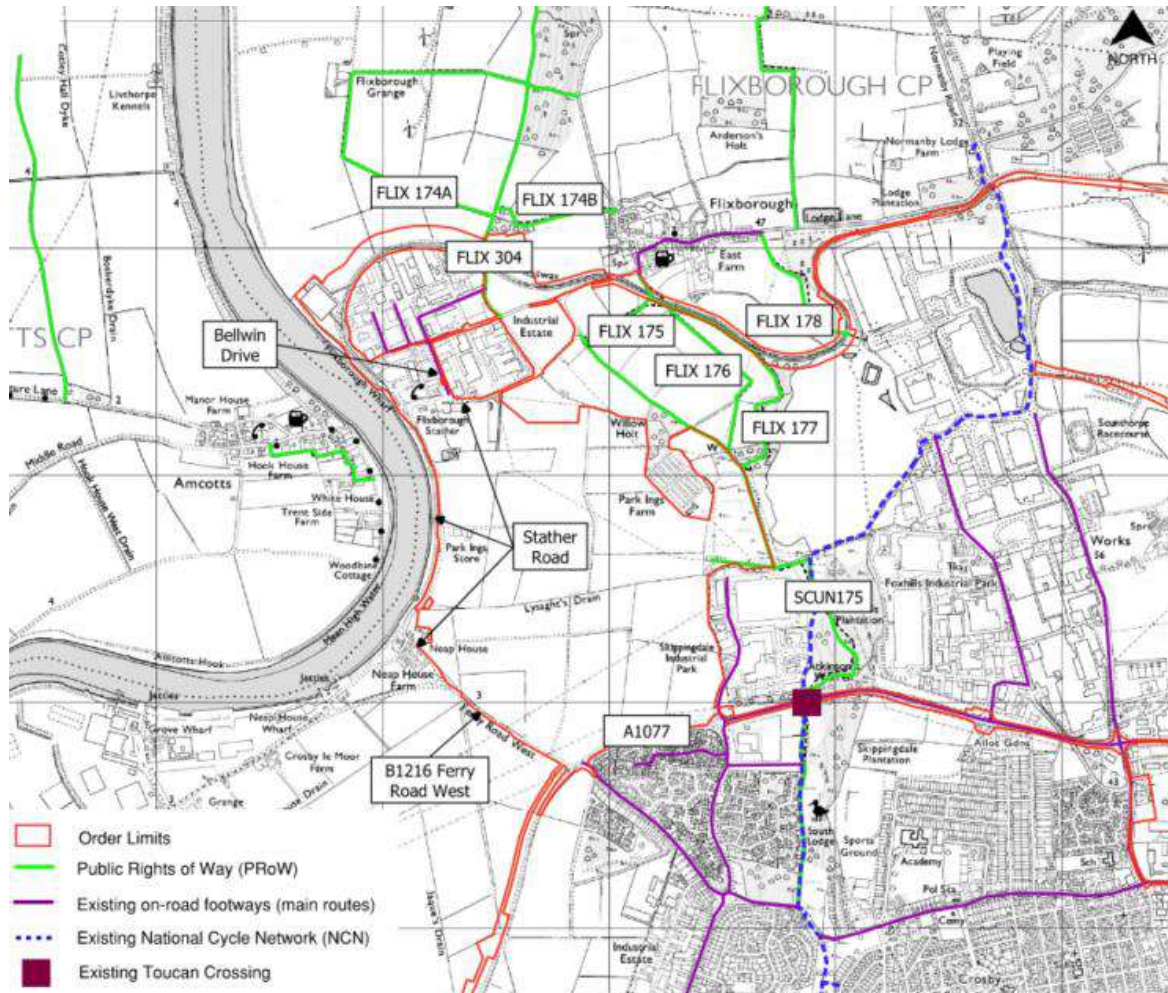

Figure 3.8 – Existing Pedestrian / Cycle Infrastructure

3.4.2 National Cycle Network (NCN) Route 169 is located approximately 2.8km to the east of the Project. The route is known locally as the Scunthorpe Ridgeway and travels north to south through green open spaces and is approximately 8km in length. The route follows (off road) Normanby Road then it crosses the A1077 Phoenix Parkway just east of the Luneburg Way / A1077 Roundabout via a toucan crossing. The route then continues southwards off road to the A18 Kingsway where a segregated cycleway is provided, which is separated from the road by a grass verge. It then continues south off-road to Burringham Road.

3.4.3 There are existing pedestrian footway connections to/from NCN 169 via a number of residential streets between Ferry West Road and Luneburg Way, which also provide quiet routes for cyclists. There are also a number of Public Rights of Way (PRoW) routes which exist in the vicinity of the Project, as indicated on Figure 3.8.

3.4.4 Figure 3.9 shows the areas that can be reached within a 10, 20, and 30-minute walk based on typical walking speeds.

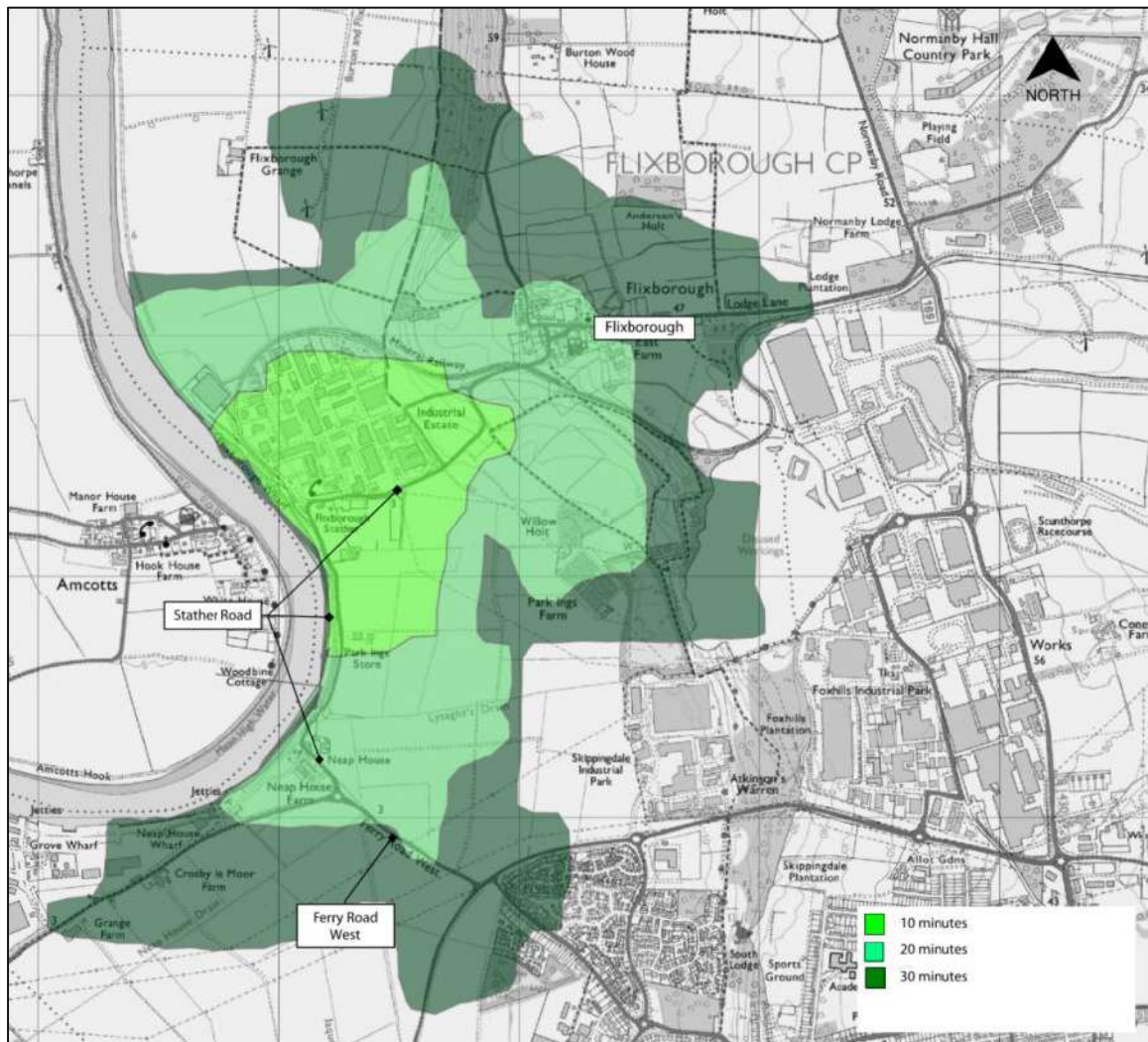

Figure 3.9 – Walking Isochrones

3.4.5 Whilst the suggested maximum walking distance for typical journeys by foot to/from commercial developments is 2km / 20 minutes’ walk time (as set out in the ‘Providing for Journeys on Foot’ Guidance by the Chartered Institute of Highways and Transportation), there may be some people who may consider walking (or running / jogging) further than this and therefore the 30-minute isochrone has also been shown.

- 3.4.6 The walking isochrones show that Flixborough village is within a 20-minute walk and Ferry Road West to the south of the A1077 is within a 30-minute walk.
- 3.4.7 Whilst Scunthorpe and Althorpe railway stations are outside reasonable walking distances, they are accessible within a 20-30-minute cycle as indicated on Figure 3.10.

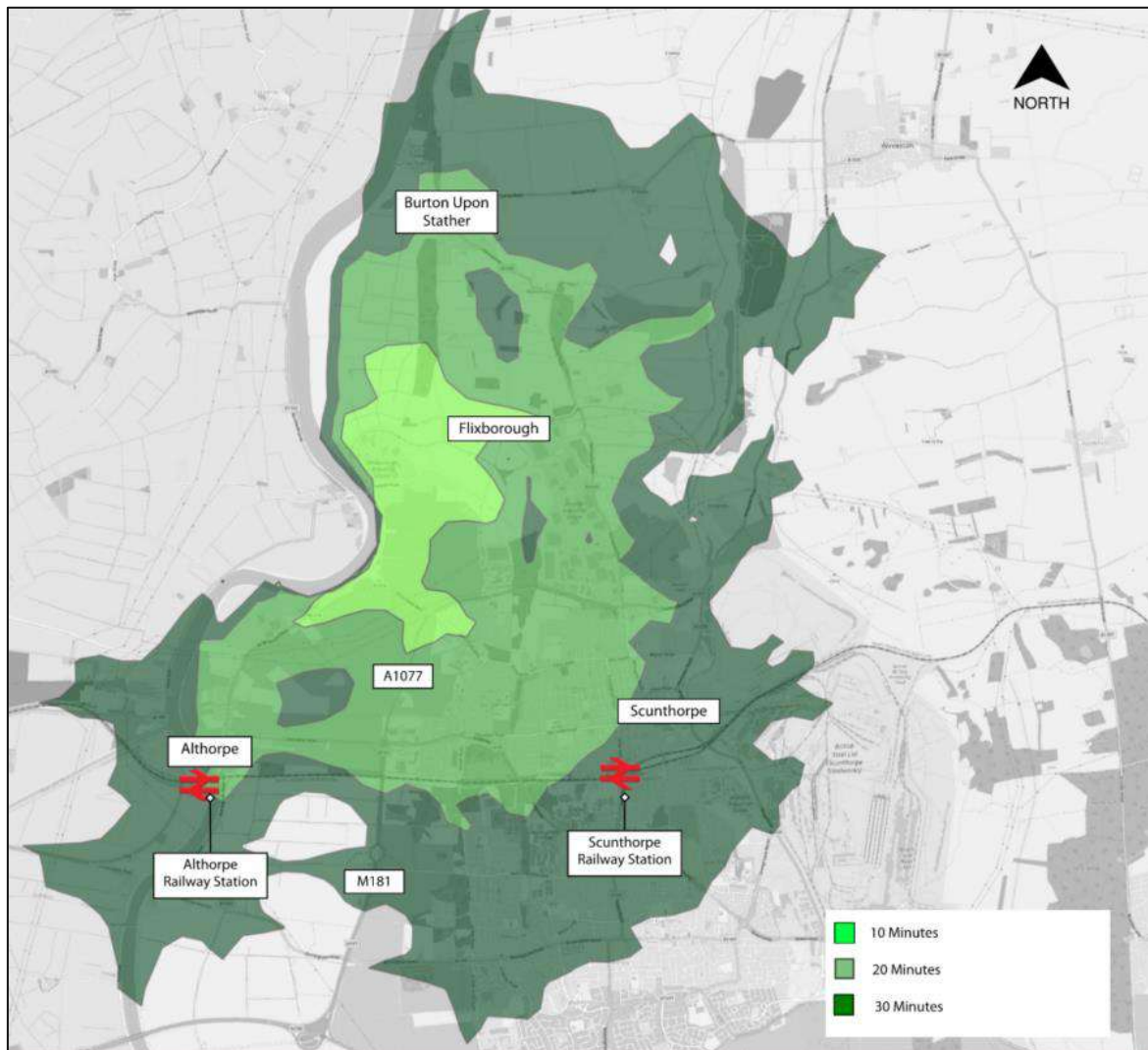

Figure 3.10 – Cycling Isochrones

- 3.4.8 Scunthorpe town centre is located approximately 20-25 minutes cycle ride from the Project where a wide range of amenities can be found. Scunthorpe railway station is also approximately 25 minutes cycle ride from the Project and Althorpe railway station is a 20-minute cycle ride approximately.

3.5 Public Transport Accessibility

Bus

- 3.5.1 The nearest bus route serving the Project (Bus Route 60) runs along Stather Road adjacent to Flixborough Industrial Estate / Flixborough Wharf. Bus Route 60 runs north-south from Whitton via Burton upon Stather and Flixborough to Scunthorpe via the bus and railway stations to John Leggott sixth form college situated to the south of Scunthorpe town centre.
- 3.5.2 The 'Flixborough Stather Wharf' bus stops are situated on Stather Road adjacent to the Flixborough Wharf access. There is no physical bus infrastructure provided at this location (such as bus stops etc) as this bus route forms part of NLC's rural bus network, which operates an on-demand bus service via 'JustGo North Lincs'.
- 3.5.3 The 'JustGo North Lincs' on demand bus service allows passengers to book and pay online for their bus journey through the JustGo mobile app, as well as choosing where they get picked up from. The service can be booked up to 30 days in advance up until the day of departure.
- 3.5.4 There are additional bus services (Routes 7 and 8) available via Ferry Road West with bus stops located approximately 90 metres south of the A1077. These bus stops are within a 10-minute cycle ride / 30-minute walk of the Project.
- 3.5.5 A summary of the bus routes and service frequencies in the vicinity of the Project is shown below in Table 3.1.

Table 3.1 – Bus Routes and Service Frequencies

Bus Route	Monday to Friday	Saturday
60 Scunthorpe bus station via Flixborough to Whitton	Northbound	
	First Bus from Scunthorpe bus station: 1000 Arriving at Flixborough Stather Wharf at 1015 Then at 1115 1220 1450 1645 1645 and 1800 towards Whitton	Same timetable as Weekday
	Southbound	
	First Bus from Whitton: 0730 Arriving at Flixborough Stather Wharf at 0800 Then at 0939 1045 1145 1318 and 1543 towards Scunthorpe	Same timetable as Weekday

7 Scunthorpe bus station to Skippingdale Retail Park	Northbound Only	
	First Bus from Scunthorpe bus station: 0905 Arriving at Ferry Road West at 0922 Then hourly from Scunthorpe bus station with last bus at 1805	First Bus from Scunthorpe bus station: 09:10 Arriving at Ferry Road West at 0924 Then hourly from Scunthorpe bus station with last bus at 1810
8 Scunthorpe bus station to Skippingdale Retail Park	Northbound	
	First Bus from Scunthorpe bus station: 0935 Arriving at Ferry Road West at 0951 Then hourly with last bus from Scunthorpe at 1735	First Bus from Scunthorpe bus station: 09:50 Arriving at Ferry Road West (Charnwood Caravan Park) at 10:04 Then hourly with last bus towards Scunthorpe at 1850
	Southbound	
	First Bus from Skippingdale Retail Park: 0927 Arriving at Ferry Road West (Charnwood Caravan Park) at 0929 Then hourly with last bus towards Scunthorpe at 1829	First Bus from Skippingdale Retail Park: 0929 Arriving at Ferry Road West (Charnwood Caravan Park) at 0931 Then hourly with last bus towards Scunthorpe at 1831

* there are currently no bus services operating on a Sunday

National Rail

- 3.5.6 Althorpe railway station is the nearest station serving the proposed the Project, which is located approximately 4.3 kilometres south-west of the proposed the Project on the opposite side of the River Trent, adjacent to Keadby Bridge. It is approximately 20-minute cycle ride from the Project via Stather Road and the B1216 Neap House Road.
- 3.5.7 Scunthorpe railway station is located a short walk from Scunthorpe town centre, which is approximately 4.5 kilometres south-east of the proposed the Project and can be reached by bus (approximately 15 to 20-minute bus journey) or by cycle (approximately 250-minute cycle ride).
- 3.5.8 Scunthorpe and Althorpe stations are both served by Northern Trains (NT) and the TransPennine Express (TPE).
- 3.5.9 Scunthorpe station has two platforms, Platform 1 serves mainly TPE eastbound trains towards Grimsby / Cleethorpes with some NT westbound services towards Doncaster. All westbound TPE services, and most NT services use Platform 2.

3.5.10 There is an hourly TPE service eastward to Cleethorpes and westbound there in an hourly TPE service to Manchester Piccadilly and Manchester Airport, with an hourly local NT service calling at all intermediate stations towards Doncaster. Trains operate throughout the week (Monday to Sunday).

3.5.11 Scunthorpe station has step free access from the station entrance to all platforms.

3.5.12 Althorpe railway station is mainly served by NT, which operates east-west from Scunthorpe via Althorpe, Crowle to Doncaster and onward connections to Sheffield. There are also occasional TPE services via this station. Train services operate Monday to Saturday with an hourly service.

3.5.13 Althorpe station has two platforms, Platform 1 (Eastbound) and Platform 2 (westbound) and the station does not currently provide step free access with Platform 1 only accessible by a footbridge with steps.

3.5.14 Table 3.2 provides an overview of the train frequencies at these railway stations.

Table 3.2 – Train Frequencies at Scunthorpe and Althorpe Stations

Destination	Weekday AM	Weekday PM	Saturday	Sunday
Scunthorpe Station				
Doncaster	Every 30 Minutes	Every 30 Minutes	Every 30 Minutes	Hourly
	First Train: 05:47	Last Train: 22:48	First Train: 05:47 Last Train: 22:48	First Train: 10:07 Last Train: 21:58
Cleethorpes	Hourly	Hourly	Hourly	Hourly
	First Train: 06:19 Last Train: 23:12	First Train: 06:19 Last Train: 23:12	First Train: 06:19 Last Train: 23:12	First Train: 10:04 Last Train: 23:05
Manchester Piccadilly	Hourly	Every 30 Minutes	Every 30 Minutes	Hourly (with intermediate changes)
	First Train: 05:47	Last Train: 22:48	First Train: 05:47 Last Train: 22:48	First Train: 10:07 Last Train: 21:08
Althorpe Station				
Doncaster	Hourly	Hourly	Hourly	No Services
	First Train 05:52	Last Train 22:53	First Train: 05:52 Last Train: 23:06	

* Intermediate Changes are required.

3.6 Transport Assessment Study Area

3.6.1 The transport assessment study area agreed in principle with NLC and NH is shown on Figure 3.11.

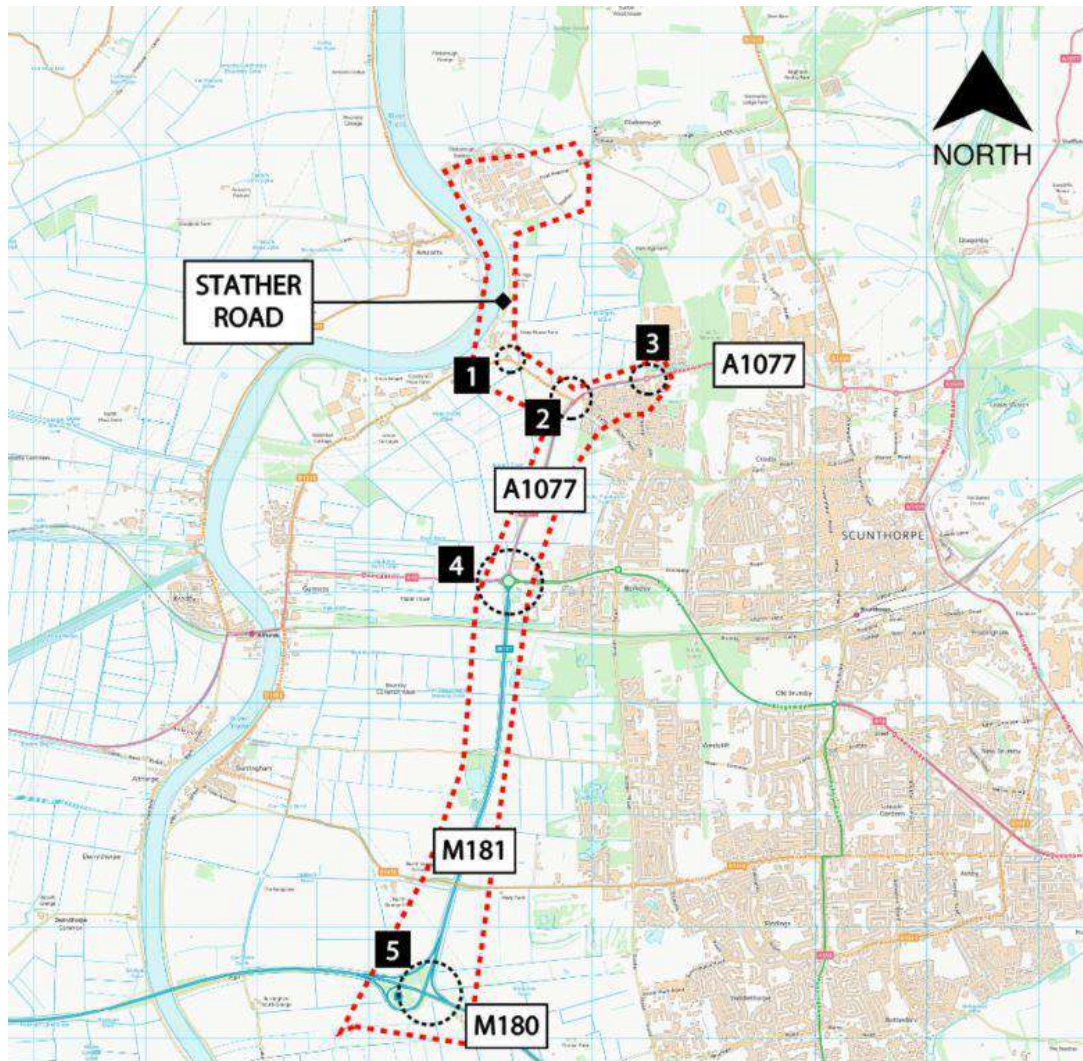

Figure 3.11 – Transport Assessment Study Area

3.6.2 The main junctions included in this study area are outlined below:

- Junction 1: Neap House Roundabout
- Junction 2: A1077 / B1216 Ferry Road West Signal Junction
- Junction 3: Skippingdale Roundabout
- Junction 4: A1077 / A18 Roundabout; and
- Junction 5: M181 / M180 Junction Slip Roads.

3.7 Assessment of Collision Data

- 3.7.1 Existing collision statistics have been obtained from NLC for the most recent five years to September 2021 covering the junctions and highway links included in the Study Area. It is noted that this is the most up to date information available at the time of writing this report.
- 3.7.2 A plot of these collisions is included in Appendix B.
- 3.7.3 Collision statistics are reviewed in terms of numbers and severity to ascertain whether there are particular trends or patterns at a particular junction or section of road. If there is a trend or statistically high collision record that would require remedial works, then this could be considered as 'significant'.
- 3.7.4 Collisions recorded at the junctions within the Study Area during the five-year period to 8th September 2021 are summarised in Table 3.3 below.

Table 3.3 – Collision Data Summary (Five Year period January 2016 to September 2021)

Severity	January 2016 – December 2016	January 2017 – December 2017	January 2018 – December 2018	January 2019 – December 2019	January 2020 – March 2021	March 2021 – September 2021	Total
Slight	4	10	10	10	6	8	48
Serious	1	4	5	0	1	2	13
Fatal	1	0	0	0	0	0	1
Total	6	14	15	10	7	10	62

- 3.7.5 As shown in Table 3.3, a total of 62 collisions were recorded across the five-year period, of these, one resulting in fatal injury, 13 in serious injury and 48 in slight injury.
- 3.7.6 The majority of collisions occurred in dry and fine conditions. Around 3% (2) of the collisions occurred during the morning highway peak hour (8:00 – 09:00) and 8% (5) occurred during the evening peak hour (16:00 – 17:00). The majority of collisions (48%) were spread across the day between 0900 and 1600 with 18% occurring after 6pm.
- 3.7.7 Table 3.4 summarises the main cluster of collisions at junctions within the study area.

Table 3.4 – Number of Collisions by Junction

Severity	First Avenue / Bellwin Drive	Gunness Lane / Stather Road	B1216 Ferry Road West / A1077	Skippingdale Roundabout	A1077 / A18 Roundabout	M180 / M181
Slight	2	0	4	1	25	7
Serious	0	1	1	0	8	1
Fatal	0	0	0	0	0	1
Total	2	1	5	2	33	9

3.7.8 No collisions were recorded along Stather Road between Bellwin Drive and Neap House to the south.

3.7.9 A summary of these collisions is set out below.

First Avenue / Bellwin Drive

3.7.10 There was a total of two collisions recorded at this junction across the 5-year period, both of which resulted in slight injury. One collision occurred when conditions were wet when a driver failed to look properly when pulling out of the junction into the path of an oncoming HGV. The other collision occurred when it was dark where two cars collided resulting in slight injury.

Gunness Lane / Stather Road

3.7.11 There was one collision recorded at this junction across the 5-year period, resulting in serious injury. This collision occurred when it was dark on the Stather Road east arm. The main contributing factors to the collision were classified as aggressive driving, as a result of alcohol and drugs consumption.

B1216 Ferry Road West / A1077 Signal Junction

3.7.12 A total of five collisions were recorded at this junction during the five-year period. Four incidents resulted in slight injury and one resulted in serious injury. It is noted that three of these collisions occurred prior to the installation of traffic signals in 2019, when the junction was a staggered priority junction. The recent incidents which occurred in 2021 were both classified as slight. One incident involved a car and a cyclist and occurred on Ferry Road West 38m from the signalised junction. The other incident involved a car by itself and the cause is not known.

Skippingdale Roundabout

3.7.13 One collision was recorded at this junction during the five-year period, which occurred in March 2021 and resulted in slight injury. The collision involved a car leaving the carriageway and hitting a tree.

A1077 / A18 Roundabout

3.7.14 A total of 33 collisions were recorded at this roundabout across the five-year period, with 25 involving slight injury and 8 resulting in serious injury.

3.7.15 One collision involved a cyclist (2018) resulting in serious injury. The cyclist collided with the back of a car in the process of stopping on the western arm of the A18 on the approach to the roundabout, with the contributory factor being sighted as the car driver failing to look properly.

3.7.16 Ten of the collisions involved a HGV or bus, of which 8 resulted in slight injury and 2 serious injuries. Three collisions involved motorcycles, one of which resulted in serious injury but appeared to be as a result of driver error (collided with the barrier).

M180 / M181 Junction

3.7.17 A total of nine collisions were recorded at the M180 / M181 junction across the five-year period. Seven of these collisions resulted in slight injury, one in serious injury and one collision resulted in a fatality.

3.7.18 The fatality occurred in July 2016 at 17:25 and involved two HGV's. It appears that it was a result of driver error where one driver failed to judge the other HGV's path / speed causing him to swerve, the collision occurred on the slip road of the M181 to the M180 heading eastbound.

3.7.19 The collision involving serious injury also involved two HGV's and were as a result of driver error where one driver performed a poor manoeuvre and/or failed to look properly.

A1077 / M181 (between A18 and M180)

3.7.20 A total of 5 collisions were recorded on the A1077 / M181 between the A18 and the M180, all of which resulted in slight injury. Four of these collisions involved an HGV and occurred at the same location but on differing occasions. The collisions occurred across different years with two occurring in 2016, one in 2017 and two in 2020 (September and December). All the collisions had different main contributing factors which loss of control, sudden braking, overloaded trailer and failing to look properly all cited.

Collision Analysis Summary

3.7.21 In summary, the highway network within the study area does not appear to have a significant collision record over the five-year period. Whilst there were some common attributes between the collisions recorded during the study period, the highway layout would not appear to be a contributory factor. In conclusion, the collision records do not suggest that any specific remedial works are required.

4 Baseline Traffic Flows

4.1 Observed Traffic Flows

- 4.1.1 Classified turning counts and Automatic Traffic Counts (ATCs) were undertaken in October 2020 (outside of the school holidays) for the morning peak period (07:00 to 11:00) and the evening peak period (15:00 to 19:00) at the junctions included in the study area. The scope of these surveys was agreed with NLC as part of the TA scoping discussions.
- 4.1.2 Queue lengths were also observed at the junctions to assist with validating the junction capacity analysis.
- 4.1.3 The resultant highway peak hours were shown to be 08:00 to 09:00 during the morning and 16:00 to 17:00 during the evening.
- 4.1.4 The 2020 observed traffic flows for the morning and evening peak hours are shown on Figure C1 and Figure C2 in Appendix C.

4.2 2021 Baseline Traffic Flows

- 4.2.1 Given the current COVID-19 pandemic situation, appropriate adjustment factors have been applied to the observed traffic flows to ensure they are representative of pre-COVID traffic conditions i.e. worst case for assessment purposes. These adjustment factors were agreed in principle with NLC and HE as part of the TA scoping discussions (refer to scoping correspondence in Appendix A). The resultant traffic data has been used in this assessment to represent the 2021 baseline conditions.
- 4.2.2 The 2021 baseline traffic flows for the morning and evening peak hours are shown on Figure D3 and Figure D4 included in Appendix D.

4.3 Stather Road Stopping Up – Traffic Re-distribution

- 4.3.1 In order to facilitate the core elements proposed on the Project, it is proposed to stop up a section of highway on Stather Road between Flixborough Industrial Estate and the existing surface water pumping station situated 160 metres north of Neap House, as shown on Drawing SK03 at Appendix E.
- 4.3.2 As part of the stopping up proposals, allowance will be made at the pumping station for a full-size articulated vehicle (16.5m in length) to turn around and the vehicle swept paths are included in Appendix E. A layby is proposed to facilitate this manoeuvre (as indicated on the highway improvement drawings in Appendix F).

4.3.3 The existing traffic along this route would be re directed along the proposed New Access Road between the B1216 Ferry Road West and Flixborough Industrial Estate (as discussed in Section 5).

4.3.4 The redistribution of traffic associated with the stopping up of Stather Road and the New Access Road can be seen on Figures C5, C5a, C6 and C6a at Appendix C.

4.4 Background Traffic Growth

4.4.1 The anticipated year of opening for the core elements proposed on the Project is 2028. Additional horizon years have also been considered as part of the junction capacity analysis as set out below:

- 2028 (opening year)
- 2033 (opening year + 5 years, to include 1,800 dwellings proposed at Lincolnshire Lakes); and
- 2038 (horizon year to include for the 3,000 dwellings proposed at Lincolnshire Lakes as per the Local Plan allocation - discussed later in this section).

4.4.2 The future baseline years account for changes that would occur irrespective of the Project coming forward (i.e. observed flows + committed development).

4.4.3 It has been agreed with NLC and NH as part of the TA scoping discussions that committed development traffic should be included in the future baseline traffic flows and that the separate application of TEMPRO growth rates (background traffic growth) would not be required.

4.5 Committed Developments

4.5.1 The full list of committed / cumulative schemes is contained in the ES. An assessment was undertaken as part of the TA scoping study to determine which are considered significant in transport terms for inclusion in the TA.

4.5.2 The list of committed developments included as part of the TA is set out in Table 4.1, which has been agreed in principle with NLC.

Table 4.1 – Committed Developments included in TA

Name	Planning Application Reference	Type of Development	Forecast Opening Year
Lincolnshire Lakes	PA/2013/1000 (Approval Granted - consent now lapsed) PA/2013/1001 (Approval Granted - consent now lapsed) PA/2017/1386 (Approval Granted) PA/2015/0628 (Recommendation for Approval subject to s106)	Up to 3,000 residential dwellings and other mixed uses – to be built in phases	programme agreed with NLC: 600 units by 2028 1,800 units by 2033 3,000 units by 2038 Trip Generation included in future baseline assessments
Glanford Park Football Stadium extension	PA/2018/1388; PA/2018/1389; and PA/SCR/2018/10 (Approval Granted)	Stadium extension (employment) and 160 Residential units	Status unknown Assumed to be completed by 2028 - trip generation included in future baseline assessments
Normanby Enterprise Park	PA/2020/1115 PA/2020/1595; and PA/2020/113 (Approval Granted)	Industrial – change of use	Forecast Opening Year in TA = 2025 Status unknown Assumed to be completed by 2028 - trip generation included in future baseline assessments
Land off Burringham Road, Ashby Parklands, Scunthorpe	PA/2020/1333 – Approval Pending	Residential 144 dwellings	Forecast Opening Year in TA = 2024 Status unknown Assumed to be completed by 2028 - trip generation included in future baseline assessments
Brumby Resource Centre, East Common Lane	PA/2015/1369 - Outline Approval granted	Residential 122 dwellings	Forecast Opening Year in TA = 2020 Status unknown Assumed to be completed by 2028 - trip generation included in future baseline assessments

4.5.3 The location of these committed developments is shown on Figure 4.1.

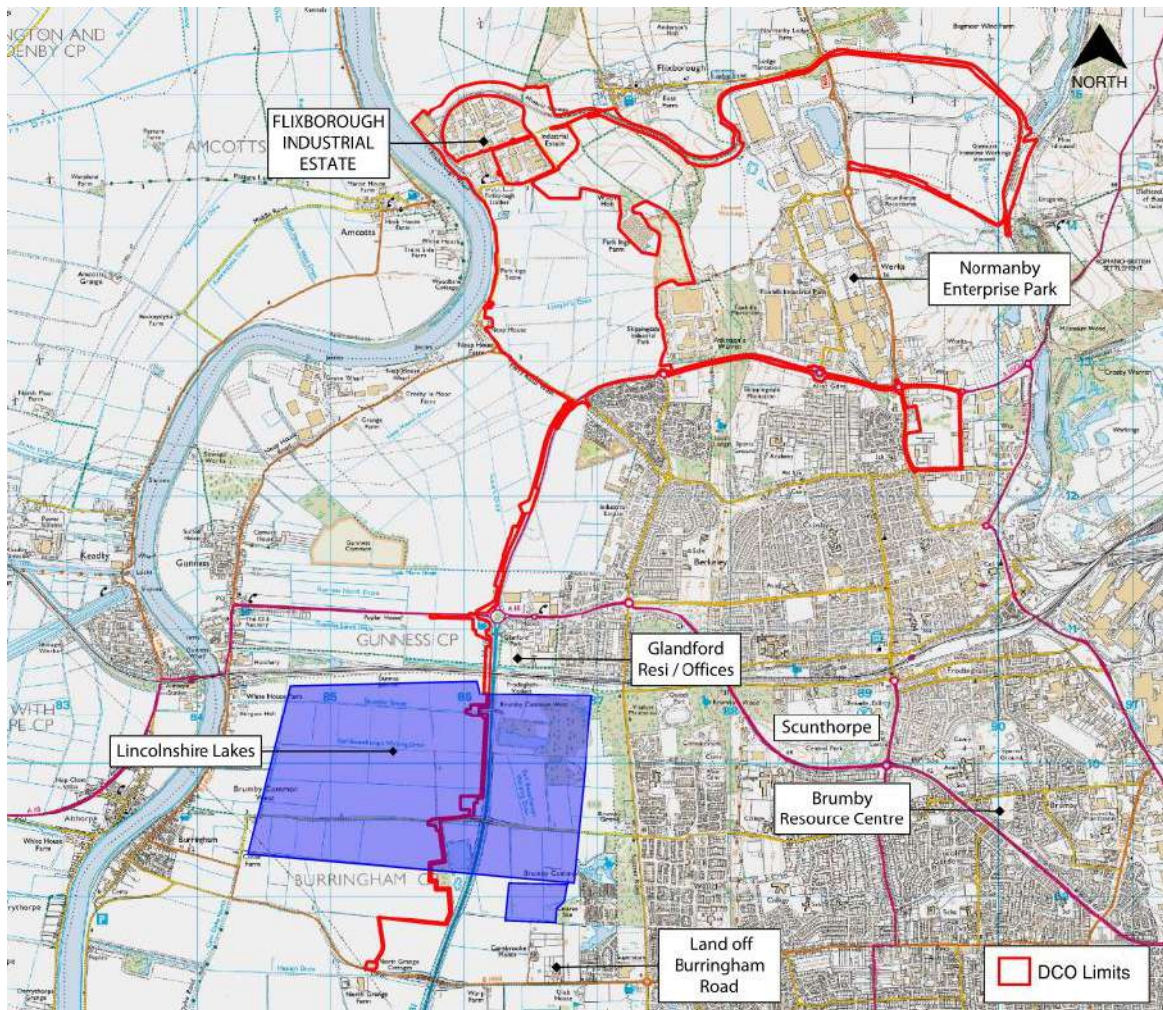

Figure 4.1 – Location of Committed Developments

Lincolnshire Lakes

4.5.4 The proposed Lincolnshire Lakes development includes the creation of new homes, a high-quality business park and office accommodation.

4.5.5 The trip generation associated with this development has been based on information contained in the supporting Transport Assessment (dated August 2013) and the following assumptions agreed with NLC:

- 600 dwellings would be built by 2028 (opening year)
- 1,800 dwellings would be built by 2033 (5 years after opening); and
- 3,000 dwelling would be built by 2038 (as per the Local Plan allocation).

4.5.6 The generated traffic for the Lincolnshire Lakes development is shown on Figure C11, C14 and C17 in Appendix C.

4.5.7 As part of the Lincolnshire Lakes development, a new roundabout has been constructed on the M181, to the north of Brumby Common Lane, located approximately 2km north of the M180. Whilst the east-west approaches at the roundabout are in place, these are not currently in use but will become operational once the Lincolnshire Lakes development is completed. As part of these works, the section of road between this new roundabout and the A18 to the north has been downgraded from a trunk road (M181) to normal highway (A1077) under NLC's control.

Glanford Park

4.5.8 The proposed Glanford Park development includes the redevelopment of an existing football stadium as well as creating commercial office space and 160 residential apartments.

4.5.9 The trip generation associated with this development has been based on information contained in the Transport Assessment submitted in support of the planning application (s). The opening year of the development wasn't mentioned in the TA however we have assumed an opening year of 2028.

4.5.10 The generated traffic for the Glanford Park development is shown on Figure D7 and D7a (Appendix D) and is forecast to be completed by 2028.

Land off Burringham Road

4.5.11 The proposed Burringham Road development is for 144 residential dwellings. It is understood that the planning application is still to be determined but has nevertheless been included in the assessment.

4.5.12 The trip generation associated with this development has been based on information contained in the Transport Assessment submitted in support of the planning application, which included reference to an opening year of 2024.

4.5.13 The generated traffic for the Burringham Road development is shown on Figure C8 in Appendix C.

Normanby Enterprise Park

4.5.14 The proposed Normanby Enterprise Park development includes a change of use from B8 use class (storage or distribution) to B2 use class (general industrial).

4.5.15 The trip generation associated with this development has been based on information contained in the Transport Assessment submitted in support of the planning application, which included reference to an opening year of 2025.

4.5.16 The generated traffic for the Normanby Enterprise Park development is shown on Figure C9 in Appendix C.

Brumby Resource Centre

4.5.17 The proposed Brumby Resource Centre includes 122 residential dwellings.

4.5.18 The trip generation associated with this development has been based on information contained in the supporting Transport Assessment submitted in support of the planning application, which included reference to an opening year of 2020. Its status is unknown but has nevertheless been included in the future baseline traffic flows.

4.5.19 The generated traffic for the Brumby Resource Centre is shown on Figure C10 in Appendix C.

4.5.20 The future baseline traffic flows for 2028, 2033 and 2038 (inclusive of committed development traffic) are included in Appendix C.

5 Proposed Development

- 5.1.1 The proposed layout of the core elements on the Project is included in Appendix D.
- 5.1.2 The proposed Energy Recovery Facility (ERF) will be capable of efficiently recovering energy stored within waste products. The ERF will have a capacity to convert up to 760,000 tonnes of waste per year, into electricity, with a maximum gross output of up to 95 megawatts electrical power (MWe). Energy is released through combustion of the waste and the heat released by the combustion process is utilised within a boiler to generate steam, used to drive a steam turbine and electricity generator.
- 5.1.3 The waste used to fuel the facility is known as refuse derived fuel (RDF), made up of municipal solid waste, or commercial or industrial waste of a similar composition, that has undergone treatment and sorting to remove larger inert/non-combustible materials, fine materials (including a proportion of organic matter) and any waste that could be recycled.
- 5.1.4 Following combustion, ash from the process will be transferred to the bottom ash and flue gas residue handling and treatment facility (RHTF). Once treated, the ash residues will be transferred from the RHTF to the concrete block manufacturing facility (CBMF). Within the CBMF, the treated ash will be combined with imported sand and cement to manufacture concrete blocks. The manufactured blocks will then be exported to market from the Project via road, river and train.
- 5.1.5 There will also be a plastic recycling facility (PRF), which will treat source-segregated waste plastics to produce pellets or flakes of 'raw' plastics, free of contaminants that can be used to manufacture new plastic products without the use of fossil fuels.
- 5.1.6 Additional facilities include up to two hydrogen (H₂) production and storage facilities, up to two hydrogen and natural gas above ground installations (AGI) to allow for offtake of natural gas and injection of hydrogen produced on the Project into the gas grid, and an electric vehicle (EV) and hydrogen (H₂) refuelling station and battery storage area.
- 5.1.7 A gatehouse and associated weighbridges are proposed at the main entrance to the ERF and the RHTF, which will control HGV and other operational vehicle access. There will also be a Visitor Centre located adjacent to this, which will provide a secure access to view the ERF from an elevated walkway and will integrate public access to the newly established wetland area.

- 5.1.8 The Project will also include the construction and operation of a new railhead to the south of Flixborough Wharf, with the primary purpose of facilitating the delivery and export of materials to and from the Project to reduce the need for road vehicle movements and to increase capacity which will help to minimise rail movements overnight.
- 5.1.9 The railhead will be located along the west side of the Project, between the ERF and the east bank for the River Trent. It will be set back from the river to reduce potential impacts on riparian ecological receptors and will comprise three parallel tracks or sidings which will facilitate the offloading and loading of trains. The railhead will also incorporate a hardstanding apron for the movement of slave vehicles and associated turning areas.
- 5.1.10 The sidings at Dragonby will be reinstated to facilitate movements overnight being held at Dragonby.
- 5.1.11 The likely hours of operation for the core elements on the Project are set out below:
- ERF / carbon capture, utilisation and storage facility/ water treatment facility / hydrogen (H₂) production and storage facility /AGIs / RHTF / new Railhead and reinstated railway line = 24 hours a day, 365 days (equivalent to 8,760 hours) per year with shutdowns only for scheduled maintenance
 - plastic recycling facility = 8,300 hours per annum
 - electric vehicle and hydrogen refuelling Station = 9am to 6pm Monday to Sunday
 - concrete block manufacturing facility = 8 hours per day, five days a week, equivalent to 2,080 hours per annum; and
 - Visitor Centre = 8 hours per day, five days a week, equivalent to 2,080 hours per annum.

5.2 Highway Access

- 5.2.1 As part of the DCO application, a New Access Road is proposed between Stather Road and the B1216 Ferry Road West, which is intended to serve both the Project as well as the existing Flixborough Industrial Estate and Flixborough Wharf area.
- 5.2.2 The New Access Road will improve road connectivity in the area by removing the need for HGVs to use the existing section of Stather Road that runs parallel with the River Trent via Neap House, which is very narrow and generally unsuitable for two-way heavy goods vehicle movements.

5.2.3 In order to facilitate the core elements on the Project , it is proposed to stop up Stather Road from Flixborough Industrial Estate to the existing surface water pumping station situated 160 metres north of Neap House (as shown on Drawing SK03 at Appendix F).

5.2.4 The proposed highway access to the Project is indicated on Figure 5.1.

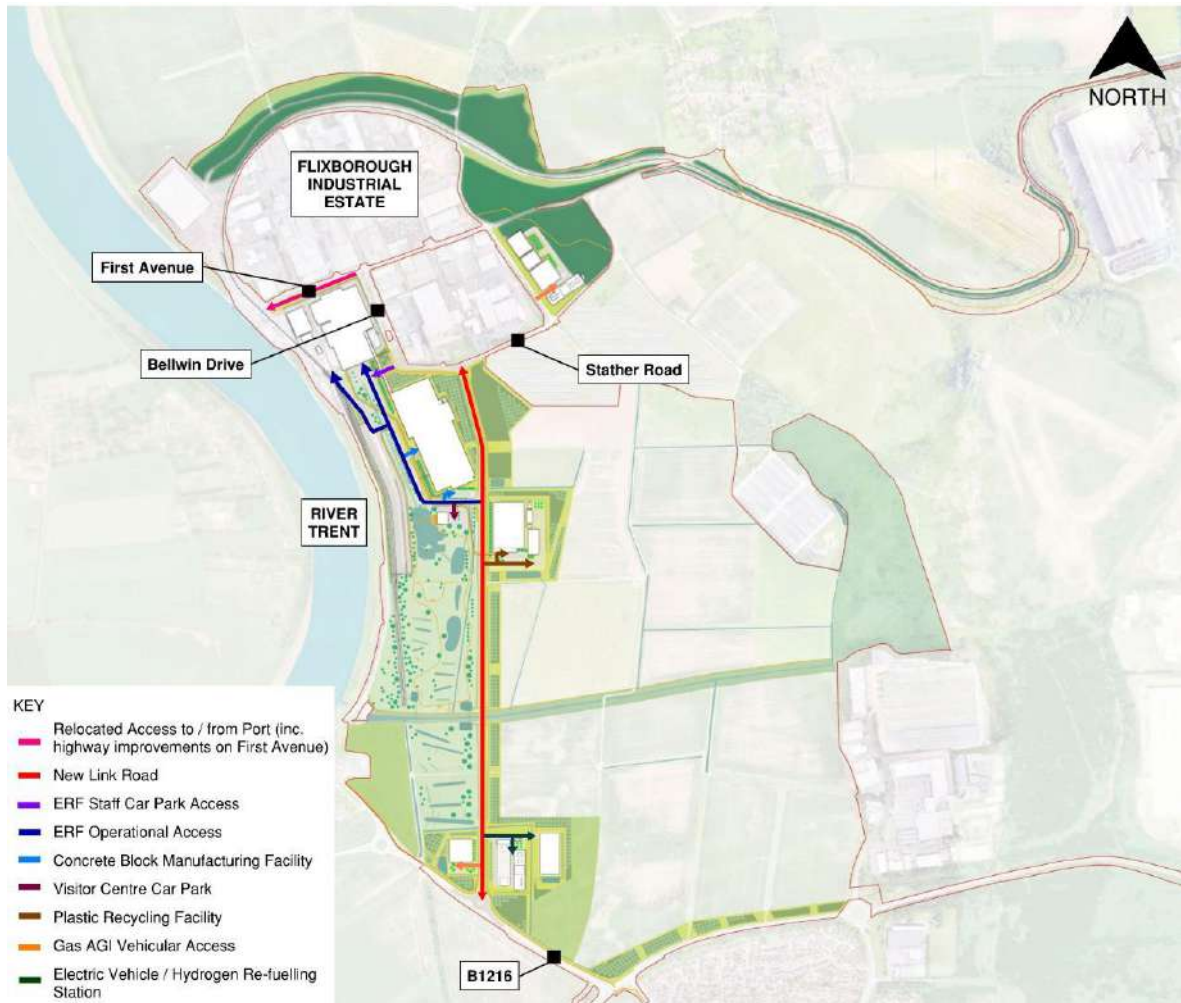

Figure 5.1 – Proposed Highway Access

5.2.5 The location and alignment of the New Access Road has been determined based on the topography, location of utilities, flood mitigation and the assessment of other local environmental constraints in the area, which has been agreed in principle with NLC.

- 5.2.6 The New Access Road runs from Stather Road to the B1216 Ferry Road West and is approximately 1.3km long. A new 3m wide shared pedestrian / cycle footway is proposed along the eastern side of the carriageway, which will extend westbound along Stather Road and connect to the existing footways on Bellwin Drive as well as along the northern side of the B1216 Ferry Road West, connecting westward to Neap House and eastward to the A1077.
- 5.2.7 A new priority junction with ghost island arrangement is proposed where the New Access Road joins Stather Road at its northern end, which ties in with the access to Bellwin Avenue and the proposed employee parking area for the ERF. The proposed layout of this junction is included in Appendix F, which has been agreed in principle with NLC.
- 5.2.8 At the southern end of the New Access Road, a new 3-arm roundabout is proposed on the B1216 Ferry Road West approximately mid-way between the A1077 signal junction and Neap House Roundabout, which has been agreed in principle with NLC. The proposed layout of this roundabout is included in Appendix F.
- 5.2.9 It is intended that the New Access Road would be constructed to adoptable highway standards to enable it to form part of the public highway maintained by NLC.
- 5.2.10 The access roads within the Project have been suitably designed to cater for the types of vehicles anticipated (described in Section 7).

5.3 Proposed Alterations to Flixborough Wharf Access

- 5.3.1 As part of the stopping up proposals on Stather Road, it will be necessary to relocate the existing main access to Flixborough Wharf (RMS Trent Ports), which is currently located 250 metres west of Bellwin Drive.
- 5.3.2 It is proposed to relocate the access to/from Flixborough Wharf to First Avenue via Bellwin Drive, which is currently used as their secondary access point. This has been agreed in principle with RMS Trent Ports as part of the ongoing discussions between the Applicant and RMS Trent Ports.
- 5.3.3 Highway improvements will be undertaken on First Avenue at the entrance to Flixborough Wharf to allow for two-way HGV movements, together with the provision of double yellow lines along both sides of First Avenue between Flixborough Wharf and Second Avenue (which is within the RMS Port's ownership) to ensure unrestricted two-way vehicle access.

5.3.4 A new section of 3m shared pedestrian / cycle footway is also proposed along First Avenue between Bellwin Drive and Flixborough Wharf in order to enhance pedestrian /cycle connections in this area.

5.4 Pedestrian and Cycle Access

5.4.1 The pedestrian and cycle access routes between the core elements on the Project are shown on Figure 5.2.

5.4.2 A new 3m shared pedestrian / cycle footway is proposed along the New Access Road and B1216 Ferry Road West, which will improve pedestrian/cycle permeability between the core elements on the Project, the surrounding industrial areas and the residential areas located south-east of the A1077 / Ferry Road West signal junction.

5.4.3 These proposals also include a new toucan crossing facility at the A1077 / B1216 Ferry Road West signal junction to enable pedestrians and cyclists to cross the A1077.

5.4.4 A new 3m shared pedestrian / cycle footway will also be provided along First Avenue between Bellwin Drive and Flixborough Wharf.

5.4.5 An elevated walkway is proposed to link the Visitor Centre to the core elements within the Project, including the plastic recycling facility. This walkway will be used by visitors only, while employees are expected to use the at-grade pedestrian and cycling infrastructure.

5.4.6 To facilitate the safe movement of pedestrians between the various the Project buildings, an elevated 3m wide walkway will be constructed. The general public visiting the facility will have controlled access to the walkway via the Visitor Centre, which will incorporate a canopy to provide rain shelter to those using it. From the Visitor Centre, the elevated walkway will extend in two directions: north to access the CBMF and the main ERF building; and to the east, spanning the New Access Road to provide safe access to the PRF.

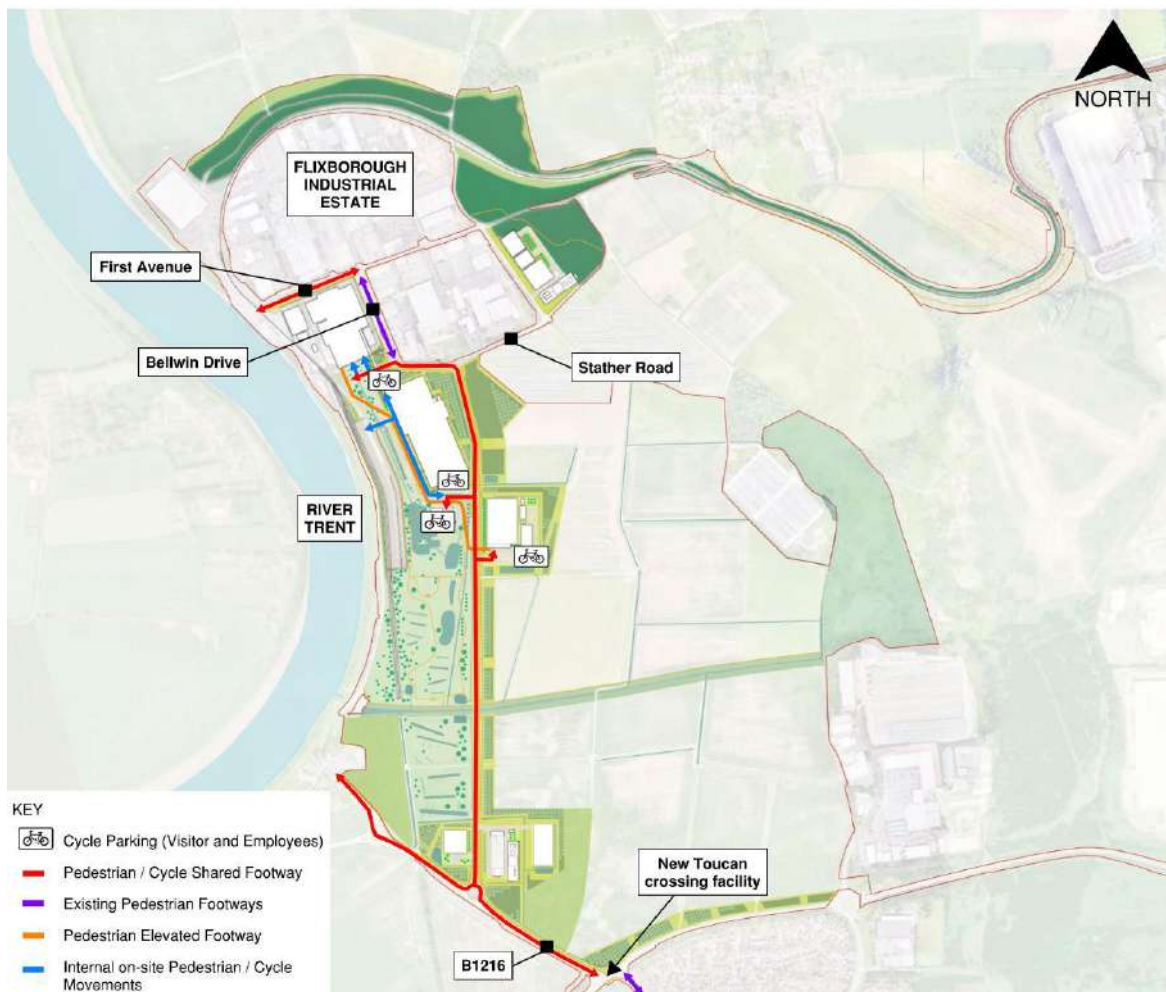

Figure 5.2 – Proposed Pedestrian / Cycle Access

5.4.7 In addition, improvements to Public Rights of Way (PRoW) routes are proposed in the area with three routes proposed across the Application Land, all of which will be enhanced to act as ecological corridors:

- a new public right of way will be created, orientated west – east, continuing to the open land at Foxhills Plantation / Atkinson’s Warren, providing a new circular walking route and connectivity between the River Trent and the northern edge of Scunthorpe
- a new public right of way will be provided along the southern edge of the railway, connecting footpaths FP/FLIX/177 and FP/FLIX/178, providing a new circular walking route to the south of Flixborough village. This will provide a formalized alternative route to the unconsented use along the existing railway; and

- a new public right of way will be provided to the east of Flixborough Industrial Estate, connecting footpath FP/FLIX/175 and FLIX/304, providing a new link that avoids the walking along Stather Road. This will include an informal crossing point with suitable drop kerbs and tactile paving is proposed where it crosses the New Access Road.

5.4.8 These PRoW improvements are indicated on the Rights of Way and Access Plans (**Document Reference 4.3**) submitted as part of the DCO application.

Parking

5.4.9 The Project does not fall within a particular land use classification and is therefore considered to be sui generis. An appropriate level of car parking has therefore been considered based on the bespoke operations of the core elements proposed on the Project.

5.4.10 In terms of disabled / accessible parking spaces reference has been made to NLC's Parking Provision Guidelines, which requires a minimum of 5% of the total car parking spaces to be allocated for disabled drivers.

5.4.11 Consideration has also been given to the provision of motorcycle parking for the core elements proposed on the Project in accordance with NLC's emerging Local Plan.

5.4.12 The proposed car and motorcycle parking provision is shown in Table 5.1.

Table 5.1 – Proposed Car and Motorcycle Parking for the core elements proposed on the Project

The Project	Standard Spaces	Disabled Spaces	Total Car Parking Spaces	Motorcycle Parking Spaces
ERF / Railhead	40	3	43	2
Plastic Recycling Facility	40	2	42	2
Concrete Block Manufacturing Facility	40	2	42	2
Visitor Centre	25	1	26	1
EV and Hydrogen Refuelling Station	5	1	6	1
Total	150	9	159	8

5.4.13 Disabled / accessible parking bays will be located as close to the main building entrance as possible and will be a minimum of 2.4m in width by 4.8m in length with a 1.2m wide hatched zone provided at the rear and side of each bay for wheelchair accessibility (in accordance with BS 8300-2:2018 Buildings Code of practice: Design of an accessible and inclusive built environment).

5.4.14 In terms of parking spaces with electric vehicle charging facilities, NLC's emerging Draft Local Plan (Policy T1p Promoting sustainable Transport and T4p Parking) specifies a minimum of 2% of the total car parking space provision where more than 50 spaces are provided. Based on 150 car parking spaces, this equates to a minimum of 3 car parking spaces with electric vehicle charging facilities to be provided. The Project will establish the infrastructure to support the growth in EV charging requirements.

5.4.15 In terms of cycle parking, NLC's Parking Provision Guidelines state that a minimum of 1 stand per 4 employees should be provided, plus additional provision for visitors. It also says that employee cycle parking should be located, where it had good all-round visibility, as close to possible to main entrances and in well-lit areas.

5.4.16 The total number of cycle parking spaces to be provided is shown in Table 5.2.

Table 5.2 – Proposed Cycle Parking at the core elements proposed on the Project

The Project	Number of Cycle Parking Spaces	
	Employee (Long-Stay)	Visitor (Short Stay)
ERF / Railhead	20	4
Plastic Recycling Facility	14	4
Concrete block manufacturing facility	14	4
Visitor Centre	4	8
Electric vehicle and hydrogen refuelling station	2	4
TOTAL=	54	24

5.4.17 The long stay (employee) cycle parking will be provided in an enclosure within the building (s) at ground floor level. The type of cycle parking being provided will be determined at the next stage as the design progresses but is likely to include good proportion of Sheffield cycle stands, which are suitable for cyclists of all ability.

5.4.18 The short-stay (visitor) cycle parking will be located adjacent to the building (s) entrances, which will be well-overlooked, covered and secure. These will be in the form of Sheffield cycle stands.

5.4.19 The proposed car parking for the core elements proposed on the Project are in accordance with NLC's parking standards.

5.5 Coach Parking

5.5.1 A coach parking space is proposed at the Visitor Centre to cater for any community trips. The coach space is located to the east of the car park and allows for a coach up to 15m in length.

5.6 Servicing and Freight Transport

5.6.1 Due to the strategic location of the Project adjacent to the River Trent and the freight rail connection, there is an opportunity to adopt river and/or rail-based transport of freight.

5.6.2 The Project will include the construction and operation of a new railhead to the south of Flixborough Wharf, with the primary purpose of facilitating the delivery and export of materials to and from the Project to reduce the need for road vehicle movements and to increase capacity which will help to minimise rail movements overnight.

5.6.3 The railhead will be located along the west side of the Project, between the ERF and the east bank for the River Trent. It will comprise three parallel tracks or sidings which will facilitate the offloading and loading of trains. The railhead will also incorporate a hardstanding apron for the movement of slave vehicles and associated turning areas. The sidings at Dragonby will be reinstated to facilitate movements overnight being held at Dragonby.

5.6.4 Options for using these rail/river modes have been explored whilst taking account of any practical constraints and commercial factors and this assessment is contained in the preliminary Navigational Risk Assessment (NRA) and Rail Operations Report (ROR) submitted as part of the DCO application.

5.6.5 For the purpose of the transport assessment, a worst-case (robust) assumption has been adopted, which assumes that all freight would be transported by road during operation. This approach has been agreed in principle with NLC and NH.

5.6.6 The core elements proposed on the Project will generate freight transport movements associated with deliveries of fuel; consumables; concrete block manufacturing materials; and collection of concrete blocks. It is estimated to generate an average of 175 one-way vehicle movements per day. If fuel is transported to the Project by rail, with all other materials by road, then the number of one-way vehicle movements would be reduced to an average of 65 one-way vehicle movements per day.

- 5.6.7 Vehicle movements / deliveries to/from the external highway are expected to take place Monday to Saturday, typically between 06:00 and 20:00 and all vehicles would be Heavy Goods Vehicles (HGVs), typically articulated HGVs (up to 16.5m in length). However, the type of vehicles servicing the Project will differ per building.
- 5.6.8 All HGV's will enter the Project via the New Access Road from the B1216 Ferry Road West and A1077 and vehicle swept path analysis for the various buildings of the proposed development is included in Appendix G (undertaken by Fichtner Consulting Engineers Ltd).

Plastic Recycling Facility

- 5.6.9 Servicing vehicles accessing the plastic recycling facility are expected to be 16.5m articulated lorries, which will arrive directly from the New Access Road, as shown on the swept path drawing TRK01 at Appendix G. The internal access road creates a loop to the back of the plastic recycling facility to allow HGVs to turn around within the building layout, with weighbridges and a security booth available at the entrance of the access road to weigh the incoming and outgoing vehicles.

ERF

- 5.6.10 Servicing vehicles accessing the ERF are expected to be 16.5m articulated lorries. HGV's will access the buildings via an access road off the New Access Road between the visitor centre and the concrete block manufacturing facility, as shown on TRK02 at Appendix G. Vehicles accessing the ERF will be directed on a clockwise loop around the ERF area, while a ramp will also be available from the access road and over the ERF car park area for HGVs to access the tipping hall directly. Delivery vehicles will then be able to turn around using the loop around the ERF area. Weighbridges and a security booth will be available on the access road, to the south of the concrete block manufacturing facility access and to the northwest of the ERF, near the Flixborough Wharf access.

Electric Vehicle and Hydrogen Refuelling Station

- 5.6.11 The electric vehicle and hydrogen refuelling station will be accessed by 16.5m articulated lorries and buses, with the swept path for articulated lorries shown in TRK03 at Appendix G. The swept path analysis shows that a HGV's will be able to adequately access and egress the five EV charging bays and access the hydrogen refuelling facility to the south.
- 5.6.12 The battery storage area will be accessed by 7.5t box van for maintenance purposes only, to replace the batteries. As shown in TRK04 at Appendix G, the 7.5t box van will go around the battery storage area on a clockwise loop from which the batteries can be individually accessed.

Gas Above Ground Installation (AGI)

- 5.6.13 The gas AGI will be accessed for ad-hoc maintenance purposes by 7.5t panel vans. The parking layout of the gas AGI to the south consists of 2 car parking spaces along with a loading area and is accessed directly off the New Access Road, as shown in TRK05 at Appendix G.
- 5.6.14 The gas AGI to the north will share its access with the adjacent substations off the unnamed road between Stather Road and First Avenue. These buildings will be accessed by 7.5t panel vans for ad-hoc maintenance purposes only. The swept path presented in TRK06 at Appendix G shows that a panel van can adequately manoeuvre within these areas.

Waste Collection

- 5.6.15 Deliveries and waste collection to the administrative buildings to the south of the CBMF and PRF will be limited, with the main related trips being admin supplies and office waste. Servicing and delivery vehicles will follow the same route as the other traffic at the Project described above (i.e. New Access Road, B1216 Ferry Road West and A1077).

5.7 Future TCPA Development

- 5.7.1 In addition to the Project, there are proposals for glasshouse and vertical farming located in the vicinity of the New Access Road. These proposals will form separate planning application in the future under the Town and Country Planning Act (TCPA).
- 5.7.2 These proposals do not form part of this DCO application but the maximum parameters being considered are set out below for informational purposes:
- around 12.46 hectares (124,600sqm) of Glasshouse development; and
 - around 2.24 hectares (22,400sqm) of Vertical Farming development.
- 5.7.3 It is noted that these future TCPA application (s) no longer include a business park or Centre of Excellence (as originally set out in the TA Scoping Report), as these elements were dismissed under a S35 submission.
- 5.7.4 The associated trip generation for these TCPA elements is not expected to be significant and would likely occur outside highway peak periods. It has therefore been agreed with NLC that it would not be necessary to include these TCPA elements as any sensitivity test analysis within this TA.

6 Trip Generation

6.1 Introduction

6.1.1 The trip generation associated with the DCO application has been based on information provided Fichtner Consulting Engineers Limited (FCE), who are the appointed design engineers, and the Applicant.

6.1.2 For the purposes of this TA, it has been assumed that 100% of freight movements would arrive and depart via road, which assumes a worst-case scenario as agreed with NLC and NH.

6.2 Employee Trips

6.2.1 The number of employees anticipated at the core elements proposed at the Project is shown below in Table 6.1.

Table 6.1 – The Project – Total Number of Employees

The Project	Total Number of Employees
ERF	62
Concrete Block Manufacturing Facility	40
Railhead	10
Plastic Recycling Facility	130
Electric Vehicle and Hydrogen refuelling station	5
Visitor Centre	10
TOTAL	257

6.2.2 The employees shift patterns and peak movements are described below for each element.

Energy Recovery Facility (ERF)

6.2.3 It is understood that there would be 62 employees working at the ERF, with a maximum of 24 employees on-site at any one time. Employees will be divided in the following categories: administrative, maintenance and operational.

6.2.4 There would be a total of 12 administrative employees associated with the ERF, these employees would work 08:00-17:00, with a morning peak of 10 arrivals and 0 departures between 0700 - 0800 and an afternoon peak of 0 arrivals and 10 departures between 1700 -1800.

6.2.5 Maintenance and operational employees will work in shifts, which start and end at different times depending on the employee job description. Operational employees will work 5 shifts (0700 – 1500, 1500 – 2300 and 2300 to 0700). Maintenance employees will work in 2 shifts (0700 – 1500 and 1500 to 2200). Employees movements will be spread throughout the day with a peak of 11 arrivals and 0 departures (between 06:00 and 07:00) and two afternoon peaks with a total of 11 arrivals and 0 departures between 14:00 and 15:00 and 0 arrivals and 11 departures between 15:00 and 16:00.

Concrete Block Manufacturing Facility (CBMF)

6.2.6 It is understood that there would be a total of 40 employees working at the CBMF, with a maximum of 40 employees on site at any one time. Employees would work from 08:00-17:00. Employees movements will result in two peaks throughout the day 07:00-08:00 and 17:00-18:00 with a peak of 34 arrivals and 0 departures (07:00-08:00) and 0 arrivals and 34 departures between 17:00 -18:00.

Railhead

6.2.7 It is understood there would be a total of 10 employees working at the proposed railhead, with a maximum of 3 employees on site at any one time. Employees would work in shifts: early 0700 – 1500, late 1500 – 2300 and night 2300 – 0700.

6.2.8 Employee's movements will be spread throughout the day with two morning peaks (0600 – 0700 and 0700 – 0800) with a peak of 3 arrivals and 0 departures (between 0600 and 0700) and 0 arrivals and 3 departures (between 0700 and 0800). There are also two afternoon peaks (1400 to 1500 and 1500 and 1600) with a peak of 3 arrivals and 0 departures (1400 – 1500) and 0 arrivals and 3 departures (between 1500 and 1600).

Plastic Recycling Facility (PRF)

6.2.9 It is understood that there would be 130 employees working at the plastic recycling facility, with a maximum of 43 employees on-site at any one time. These employees comprise a mix of administrative and operational type employees.

6.2.10 Employees will work in shifts. The shifts will start and end at different times depending on the employee's category. Typically, their shifts will be: 7am – 3pm, 3pm – 11pm and 11pm – 7am. Administrative employees will work 0800 – 1700. As a result, employee movements will be spread throughout the day with a peak of 8 arrivals and 30 departures between 07:00 and 0800 and two afternoon peaks 1400 to 1500 with a total of 30 arrivals and 0 departures and 1500 and 1600 with a total of 0 arrivals and 30 departures.

Electric Vehicle (EV) and Hydrogen (H₂) Refuelling Station

6.2.11 It is understood that there would be 5 employees working at the electric vehicle and hydrogen refuelling station, with a maximum of 3 employees on-site at any one time.

6.2.12 Employees would work in shifts, typically, 0700 to 1500 and 0900 and 1800. Employee movements peak between 07:00 and 08:00 with 12 arrivals and 7 departures and between 15:00 and 16:00 and 17:00 and 18:00 with a total of 0 arrivals and 12 departures respectively.

Visitor Centre

6.2.1 It is understood that the proposed Visitor Centre would typically attract, at most, one coach party per week and that this is likely to reduce over time. It will also have a maximum of 10 full-time employees.

Total Employees

6.2.2 There will be a total of 257 employees at the core elements proposed at the Project, with a maximum of 174 being on site at any one time as indicated on Figure 6.1.

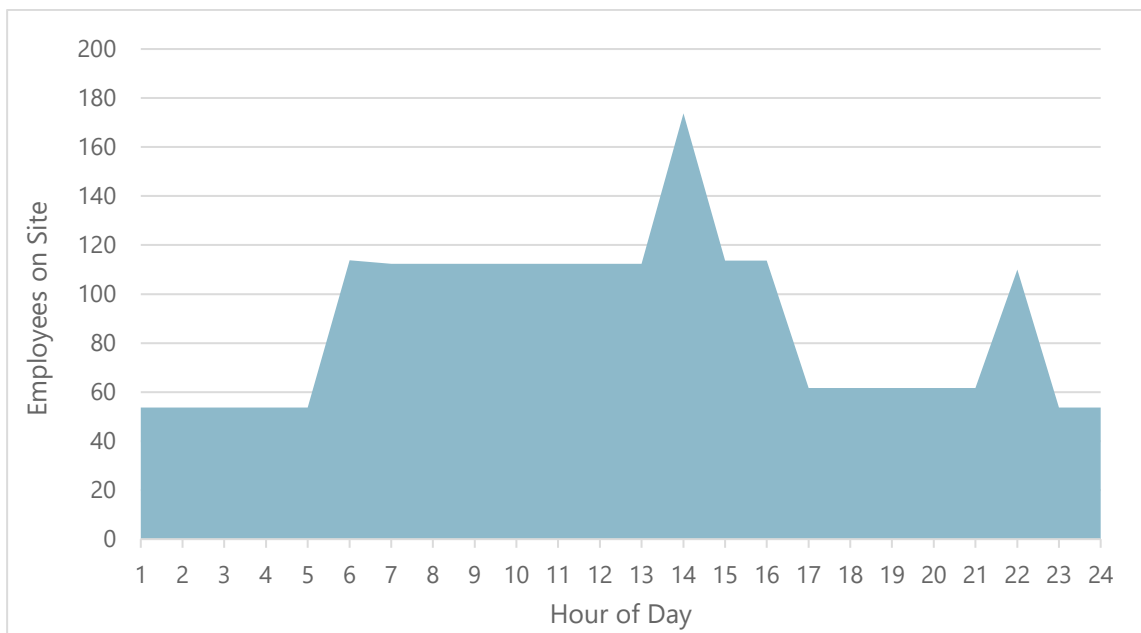

Figure 6.1 – Total Employees at the core elements proposed at the Project

6.2.3 Employee peak arrivals / departures in the morning occur between 0700 and 0800 with 52 arrivals and 53 departures and in the afternoon between 14:00 and 15:00 with 61 arrivals and 0 departures and in the evening between 2200 and 2300 with 53 arrivals and 5 departures.

6.3 Employees Modal Split

6.3.1 In order to estimate the mode split of travel by all employees, reference has been made to the Office for National Statistics 2011 Census data (travel to work patterns) for people working in this area (North Lincolnshire 005). The resultant modal split is shown in Table 6.2.

Table 6.2 – Employee Mode Split

Mode	2011 Census Mode Split (%)	Modal Split used in the TA
Car Driver	76%	76%
Car Passenger	10%	10%
Walk	6%	3%
Cycle	3%	4%
Bus	3%	4%
Motorcycle	1%	1%
Train	1%	2%
Total	100%	100%

6.3.2 The Census data shows a higher proportion of employees walking compared to public transport and cycling modes, which is not considered realistic for this particular area given its location. The walking mode has therefore been reduced and the public transport / cycling modes increased accordingly. This adjusted modal split is considered representative for the Project given the nature of the proposed development and the anticipated employee shift patterns with some employee working through the night to early morning.

6.4 Employee Trip Distribution

6.4.1 The employee trip distribution on the local highway network has been distributed based on an assessment of the Office for National Statistics (2011 Census data) travel to work patterns for people working in this area (North Lincolnshire 005) and observed vehicle movements.

6.4.2 Travel to work patterns have been established by the following method: Location of usual residence and place of work by method of travel to work (MSOA level) to assess the most likely peak hour origins and destinations to and from the core elements proposed at the Project; this has then been used to estimate the peak hour distribution by direction.

- 6.4.3 The 'place of work' location was designated as the MSOA area "E02003789", where the Project is located and the top 15 origins for those working in the area were then extracted.
- 6.4.4 The employee trip distribution for the core elements proposed at the Project can be seen on Figure 6.2.



Figure 6.2 – Employee Trip Distribution

6.5 Freight Transport Vehicle Trips

- 6.5.1 All freight transport has been assumed by road as a worst-case for the purpose of this assessment.

- 6.5.2 The core elements proposed at the Project are an industrial scale facility comprising a number of different elements (as detailed in Chapter 5 which is expected to generate freight transport movements associated with deliveries of fuel; consumables; concrete block manufacturing materials; and collection of concrete blocks. It is estimated to generate an average of 175 one-way HGV movements per day.
- 6.5.3 The majority of these vehicle movements are associated with the ERF, and vehicles will enter/exit via the proposed weighbridges where incoming/outgoing fuel is checked and recorded.
- 6.5.4 Vehicle movements / deliveries to/from the external highway are expected to take place Monday to Saturday, typically between 06:00 and 20:00 and all vehicles would be Heavy Goods Vehicles (HGVs), typically articulated HGVs (up to 16.5m in length).
- 6.5.5 A summary of typical HGV movements for the core elements proposed at the Project (Monday to Saturday) is set out below:
- Total Daily (Average) = 226 HGV arrivals, 226 HGV departures
 - Total Daily (Peak/Maximum) = 244 HGV arrivals, 244 HGV departures
 - Total in Peak Hour (1300 to 1400) = 34 HGV arrivals, 34 HGV departures
 - AM Highway Peak Hour (0800-0900) = 24 HGV arrivals, 24 HGV departures; and
 - PM Highway Peak Hour (1600 -1700) = 19 HGV arrivals, 19 HGV departures.

6.6 Other Operational Vehicle Trips

- 6.6.1 The electric vehicle and hydrogen refuelling station will also generate HGV and bus movements during the day in relation to the proposed 5 No. HGV electric charging bays and 1 hydrogen refuelling bay for buses.
- 6.6.2 It is proposed to provide a total of 5 HGV charging bays and 13 car charging bays at the refuelling station.
- 6.6.3 With reference to data available at other electric vehicle charging sites, it has been assumed that cars would arrive, charge and leave within a 35-minute window. This has the potential to generate 40 two-way trips (arrive, recharge and leave).
- 6.6.4 The electric vehicle and hydrogen refuelling station is expected to be in operation between 0900 and 1800 and could therefore generate 0 trips during the AM peak hour (0800 – 0900) and 40 two-way trips in the evening peak hour (16:00-17:00).

- 6.6.5 Based on an average of 35 minutes for an electric HGV to charge and the bays being in operation between 0900 and 1800, this could generate up to 70 HGV trips per day.
- 6.6.6 In terms of hydrogen refuelling, buses would generally be expected to arrive at the end of the day from around 1800 onwards, refuel and then return to the bus depot. Based on an average of 10 minutes for a bus to refuel and that bus times would be staggered depending on the finish time of their bus route, this could generate up to 20 buses arriving / departing between 18:00 and 20:00 with a further 10 buses arriving / departing between 20:00 and 23:00.
- 6.6.7 Table 6.3 provides a summary of the trips associated with the electric vehicle and hydrogen refuelling station in the AM and PM peak hours.

Table 6.3 – Electric Vehicle and Hydrogen Refuelling Station Trip Generation

	AM Peak Hour 08:00 – 09:00		PM Peak Hour 16:00 – 17:00	
	Arrivals	Departures	Arrivals	Departures
HGV's	0	0	8	8
Buses	0	0	0	0
EV Charging Bay	0	0	20	20
Total	0	0	28	28

6.7 Freight Transport Vehicle Trip Distribution

- 6.7.1 All HGV movements would arrive/depart via the proposed New Access Road to/from the south, via the B1216 and the A1077. The existing vehicle weight restriction on Stather Road restricts HGV movements through Flixborough village.
- 6.7.2 Beyond the A1077, HGV movements have been distributed based on observed turning movements across the study area as follows:
- 30% to/from the north-east via the A1077 and A15 Humber Bridge
 - 5% to/from the east via the A18 / A159; and
 - 65% to/from the south via the M180/ M181.
- 6.7.3 The proposed distribution of HGVs can be seen at Figure 6.3.



Figure 6.3 – HGV Distribution

6.8 Total Trip Generation

6.8.1 The total person trips generated by the core elements proposed at the Project across the whole day (typical weekday) can be seen at Table 6.4 and the total vehicle trips during the highway peak hours at Table 6.5.

Table 6.4 – Total Person Trips - Daily

Mode	Arrivals	Departures
Car Driver	195	195
Car Passenger	26	26
Walk	8	8
Cycle	10	10
Bus	10	10

Motorcycle	3	3
Train	5	5
Total	257	257

Table 6.5 – Total Vehicle Trips

Time Period	Total Vehicles *	HGVs	Buses
Daily	1,479	707	62
The Project Peak Hour (1400 - 1500)	176	83	0
AM Highway Peak Hour (0800-0900)	58	47	0
PM Highway Peak Hour (1600–1700)	95	54	1

** HGV's and Buses are included in Total Vehicles*

7 Transport Impact

7.1 Introduction

7.1.1 This section sets out the transport impact of the Project for each mode of transport.

7.2 Pedestrian/Cycle Impact

7.2.1 The number of 'main mode' walking trips generated by the core elements proposed at the Project has been considered, as well as trips generated by public transport use, as walking will make up the final mode of public transport journeys.

7.2.2 The predicted increase in pedestrian and cycle trips is shown in Table 7.1.

Table 7.1 – Pedestrian / Cycle Trips

	AM Peak Hour (08:00 – 09:00)			PM Peak Hour (17:00-18:00)		
	In	Out	Daily	In	Out	Daily
Walk (Main Mode)	0	0	6	0	0	6
Walk (Public Transport)	1	0	12	0	0	12
Cycle Trips	0	0	8	0	0	8
Total	1	0	26	0	0	26

7.2.3 Given the low number of additional pedestrian walking and cycling trips, this is not expected to have a significant impact on the surrounding pedestrian / cycle network.

7.3 Public Transport Impact

7.3.1 The public transport trips generated by the proposed development in the highway peak hours are set out in Table 7.2.

Table 7.2 – Public Transport Trips

	AM Peak Hour (08:00 – 09:00)			PM Peak Hour (17:00-18:00)		
	In	Out	Daily	In	Out	Daily
Bus Trips	0	0	8	0	0	8
Rail Trips	0	0	4	0	0	4

7.3.2 Given the low number of additional public transport trips, the proposed development is unlikely to have a significant impact on the local bus network.

7.4 Highway Impact

Percentage Impact Assessment

- 7.4.2 The net increase in traffic at each of the highway links included in the Study Area is included in Appendix H.
- 7.4.3 It shows that the largest increase on the Strategic Road Network (SRN) is 32 PCUs and 31 PCUs (two-way) on the A1077, just south of the roundabout with the A18 in the AM and PM peaks respectively. This equates to a 4% increase in relation to the future baseline traffic flows, which is not considered significant. This is shown to dissipate further at the junction with the M180 to the south where the highest increase on any highway link is shown to be 14 pcus in the AM Peak and 15 pcus in the PM peak (two-way) on the M180 (East) slip road to the M181.
- 7.4.4 The increase in traffic on the SRN is not considered significant and is therefore considered to be below NH's threshold requirements for further / detailed assessment.
- 7.4.5 The remaining junctions within the study area (with the exception of the A1077 / B1216 Ferry Road West signal junction) are shown to have a small increase in traffic as a result of the proposed development (less than 1% on all approaches) and have therefore been excluded from further / detailed junction capacity assessment.
- 7.4.6 Junction capacity analysis has been undertaken at the A1077 / B1216 Ferry Road West signal junction and the two junctions proposed at either end of the proposed New Access Road.
- 7.4.7 The junction capacity analysis has been undertaken based on the following scenarios, which have been agreed in principle with NLC:
- 2028 (opening year)
 - 2033 (opening year + 5 years); and
 - 2038 (horizon year to include for the 3,000 dwellings proposed at Lincolnshire Lakes as per the Local Plan allocation - discussed in section 4).
- 7.4.8 The traffic flows for these scenarios can be found at Appendix C.

A1077 / B1216 Ferry Road West Signal Junction

- 7.4.9 LINSIG has been used to assess the operation of this staggered signal junction, which is a nationally recognised modelling tool for the assessment of signal junctions.
- 7.4.10 The LINSIG results are contained in Appendix I together with the junction measurement parameters and existing queue observations undertaken in October 2020.
- 7.4.11 As part of the development proposals, which provides a new shared pedestrian / cycle footway via the New Access Road and B1216 Ferry Road West, a new toucan crossing facility with a 4m wide central island is proposed at the A1077 / Ferry Road West signal junction to enable pedestrians and cyclists to cross the A1077 and join the existing footway connection to the south via Ferry Road West. In order to incorporate this staggered toucan crossing facility, some minor alterations are proposed to the existing signal junction layout on the A1077. The proposed signal junction arrangement is included Drawing SK04 at Appendix G.
- 7.4.12 The LINSIG assessment has been undertaken based on the assumption that the pedestrian / cycle demand for the toucan crossing would be infrequent (every other cycle) during highway peak periods, which is considered representative at this location.
- 7.4.13 The LINSIG analysis shows that the proposed signal junction layout is expected to operate satisfactorily in 2028 and 2033 (5 years after opening) with development traffic with a Degree of Saturation (DoS) below 90% on all approaches during the AM and PM Peak Hours.
- 7.4.14 The sensitivity assessment undertaken for 2038 (with 3,000 residential dwellings in place for Lincolnshire Lakes) indicates that whilst there is expected to be a DoS of 95% on the A1077 (SW) approach, the predicted queueing can be adequately accommodated within the lane capacity on this approach. The remaining approaches are all shown to operate with a DoS below 90% with queueing within acceptable limits.

Stather Road / New Access Road Priority Junction

7.4.15 The Department for Transport (DfT) Junctions 9 modelling software has been used to analyse this junction, which is a nationally recognised modelling tool for assessing the operational performance of a priority junctions and roundabouts.

7.4.16 The PICADY results are contained at Appendix J, together with the junction measurement parameters.

7.4.17 The PICADY results are summarised below in Table 7.3.

Table 7.3 – Stather Road / New Access Road Priority Junction - PICADY Results

Arm	AM Peak Hour 08:00 – 09:00		PM Peak Hour 16:00 – 17:00	
	Maximum RFC	Maximum Queue (PCU)	Maximum RFC	Maximum Queue (PCU)
2028 With Development				
New Access Road (Left & Right)	0.11	0.1	0.11	0.1
Stather Road Right Turn	0.04	0.0	0.06	0.1
2038 With Development				
New Access Road (Left & Right)	0.13	0.1	0.12	0.1
Stather Road Right Turn	0.05	0.1	0.06	0.1

7.4.18 As can be seen at Table 7.3 the results show that the proposed Stather Road / New Access Road priority junction is expected to operate satisfactorily in 2028 and 2038 with a maximum Ratio of Flow to Capacity (RFC) of 0.13 with minimal queuing.

B1216 Ferry Road West /New Access Road Roundabout

7.4.19 The ARCADY results are contained in Appendix K together with the junction measurement parameters.

7.4.20 The results are summarised in Table 7.4 and show that the proposed B1216 Ferry Road West /New Access Road Roundabout is expected to operate satisfactorily in 2028 and 2038 with a maximum RFC below 0.1 with minimal queuing.

Table 7.4 – B1216 Ferry Road West /New Access Road Roundabout - ARCADY Results

Arm	AM Peak Hour 08:00 – 09:00		PM Peak Hour 16:00 – 17:00	
	RFC	Queue (PCU)	RFC	Queue (PCU)
2028 With Development				
New Access Road	0.05	0.1	0.07	0.1
B1216 Ferry Road West (East)	0.07	0.1	0.06	0.1
B1216 Ferry Road West (West)	0.03	0.0	0.03	0.0
2038 With Development				
New Access Road	0.06	0.1	0.07	0.1
B1216 Ferry Road West (East)	0.08	0.1	0.07	0.1
B1216 Ferry Road West (West)	0.04	0.0	0.03	0.0

Summary

7.4.21 In summary, the Project is not expected to have a significant impact on the local and Strategic Road Network. The junction capacity analysis shows that the proposed improvements at the A1077 / B1216 Ferry Road West signal junction (including a toucan crossing) are expected to operate satisfactorily in 2028 (year of opening), 2033 (5 years after opening) and 2038.

7.4.22 The proposed new junctions at either end of the New Access Road are also shown to operate satisfactorily with ample spare capacity in 2028 (year of opening) and 2038.

7.5 Construction Impact

7.5.1 The indicative construction programme, phasing and preliminary forecast of construction vehicles and workforce trips is set out in the Outline CLP submitted with the application.

7.5.2 The preliminary forecast of construction traffic is set out below in Table 7.5.

Table 7.5 - Peak Construction Traffic by Year

	Construction vehicles per month		Peak construction vehicles per day	
	Delivery vehicles	Workforce vehicles	Delivery vehicles	Workforce vehicles
Year 1 (2023)	650-1,080	660-4,420	30-50	35-220
Year 2 (2024)	985-2,260	5,040-9,700	45-105	250-485
Year 3 (2025)	280-2,240	10,230-15,160	15-105	510-760
Year 4 (2026)	130-775	11,730-16,020	10-40	585-800
Year 5 (2027)	130-1,680	440-10,800	10-80	20-540
Year 6 (2028)	50-560	440-1,100	5-30	20-55

(NB excludes short term outliers or reductions below typical yearly activity)

7.5.3 Some existing PRowS would be affected during the construction phase but any diversions would be temporary and pedestrian access would be maintained at all times.

7.5.4 Principal HGV routes are indicated on Figure 7.1.

7.5.5 Construction vehicle routes will be carefully managed as part of the CLP to minimise any impact on the local highway network and/or safety of road users. Mitigation during the construction phase is discussed in more detail in Section 8.

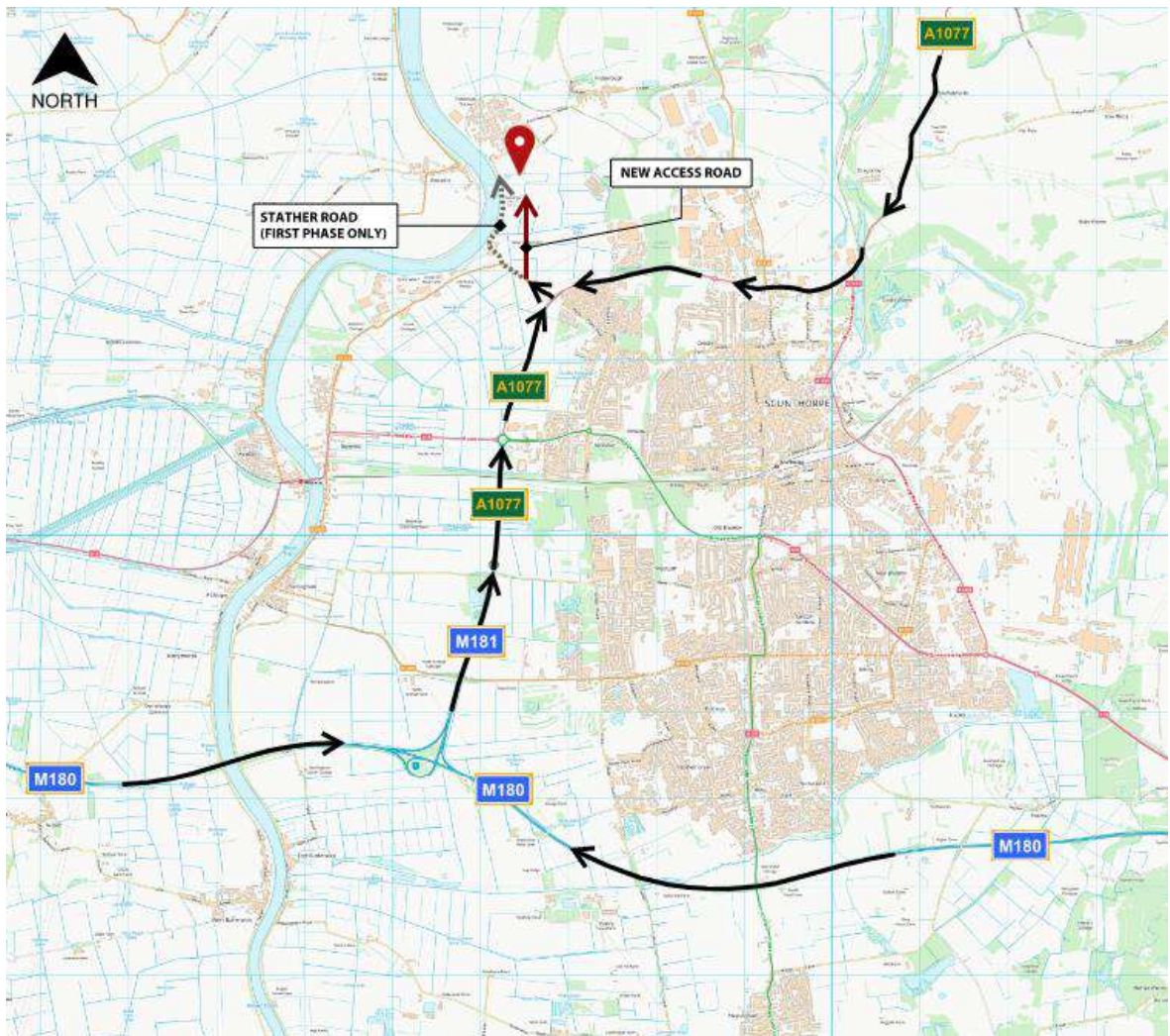

Figure 7.1 – Principal Construction HGV Access Routes

8 Mitigation Measures

8.1 Travel Planning

- 8.1.1 Travel Plans are an established way to promote and support sustainable travel at the core elements proposed on the Project.
- 8.1.2 A Travel Plan has been prepared for the core elements proposed on the Project, which has been submitted as part of the DCO application. The key aim is to inform employees and visitors of the alternatives to driving their car, to increase awareness of and promote greener, cleaner modes of travel, to reduce reliance on the private car and create sustainable communities consistent with the overarching aims of the National Planning Policy Framework.
- 8.1.3 The Travel Plan includes targets to reduce car use by 15% over the 5-year timeframe of the Travel Plan with associated measures to increase public transport, cycling and walking modes accordingly.

8.2 Walking and Cycling

- 8.2.1 The proposed development includes significant improvements to pedestrian /cycle infrastructure in the area which will improve general pedestrian and cycle connectivity for the surrounding area as well as at the at the core elements proposed on the Project. These improvements include:
- a new 3m shared pedestrian / cycle footway along the New Access Road, which will extend westbound along Stather Road and connect to the existing footways on Bellwin Drive as well as along the northern side of the B1216 Ferry Road West, connecting westward to Neap House and eastward to the A1077
 - a new toucan crossing facility at the A1077 / B1216 Ferry Road West signal junction to enable pedestrians and cyclists to cross the A1077
 - a new section of 3m shared pedestrian / cycle footway along First Avenue between Bellwin Drive and Flixborough Wharf, which will enhance pedestrian /cycle connections in the area
 - suitable drop kerbs and tactile paving at pedestrian/cycle crossing points to assist the mobility impaired and partially sighted
 - provision of a pedestrian footway infrastructure within the Project, connecting with all key buildings; and

- an elevated walkway connecting the Visitor Centre to the core elements proposed on the Project.

8.3 Public Transport

- 8.3.1 The proposed improvements to pedestrian / cycle connectivity at the Energy Land and the surrounding area will also seek to encourage the use of public transport travel modes, with local bus stops within walking distance and Scunthorpe / Althorpe railway stations within a 20-30-minute cycle ride.
- 8.3.2 As part of the proposal to stop up Stather Road via Neap House, Bus Route 60 will be diverted via the proposed New Access Road, which has been agreed in principle with NLC. This is unlikely to have a significant impact on bus journey times in the area
- 8.3.3 To further encourage the use of public transport modes as part of the Travel Plan, the Applicant will consider options for extending the existing bus timetables in the area to suit employee shift patterns at the Project and/or providing a private shuttle bus service (subject to the outcome of the baseline Travel Survey). These provisions would be considered based on employee demand and in discussion with NLC / local public transport operators.

8.4 Highways

- 8.4.1 As part of the Project, highways improvements are proposed, including the following:
- a New Access Road between B1216 Ferry Road West and Stather Road which is intended to serve both the proposed development as well as the existing Flixborough Industrial Estate and Flixborough Wharf area. The location and alignment of this New Access Road has been agreed in principle with NLC and will be constructed to adoptable highway standards
 - in order to facilitate the proposed development, it is proposed to stop up the section of Stather Road between Flixborough Industrial Estate and the existing surface water pumping station situated 160 metres north of Neap House. The existing main access to Flixborough Wharf will be relocated as a result to First Avenue, which has been agreed in principle with RMS Trent Ports; and

- new junctions are proposed at either end of the New Access Road, with a new priority junction at its northern end where it joins Stather Road, which ties in with the Bellwin Avenue access, and a new 3-arm roundabout at its southern end on the B1216 Ferry Road West approximately mid-way between the A1077 signal junction and Neap House Roundabout. These junction layouts have been agreed in principle with NLC.

8.5 Construction Traffic

8.5.1 An Outline CLP (**Document Reference 6.2.13 Appendix D**) has been submitted with the application, which includes a number of measures to help mitigate the impact of construction activities, including a traffic management plan to define construction vehicle routes.

8.5.2 It also sets out the preliminary forecast of construction vehicles. It is acknowledged in the Outline CLP that these are preliminary estimates which will be developed and updated as the design progresses to be included in the detailed CLP to be submitted prior to commencement of the works.

8.5.3 In terms of construction workforce, whilst the majority of travel is expected to fall outside the highway peak hours, a number of measures are being considered to help reduce the impact of workforce traffic (as set out in the outline CLP), which are summarised below:

- provision of a shuttle bus service / park and ride facility during peak construction periods to transport workforce from a car parking location off-site
- Construction Workers Travel Plan to encourage the use of non-car modes; and
- staggered arrival / departure times wherever possible to help minimise any impacts on the local highway network during highway peak periods

9 Summary and Conclusions

9.1 Summary

- 9.1.1 Buro Happold has been commissioned by North Lincolnshire Green Energy Park Limited to prepare this Transport Assessment in support of the Development Consent Order (DCO) application submitted to the planning Inspectorate (PINS) under Section 37 of the Planning Act 2008 (the PA 2008) in relation to the proposals at North Lincolnshire Green Energy Park (NLGEP) ('the Project') in Flixborough, North Lincolnshire.
- 9.1.2 The proposals comprise a Nationally Significant Infrastructure Project (NSIP), which requires approval by PINS on behalf of the Secretary of State.
- 9.1.3 This Transport Assessment (TA) has been submitted in support of the DCO application and assesses the transportation impacts of the proposed development. It forms part of a suite of technical documents that have been submitted, including the Environmental Statement (ES), outline Construction Logistics Plan (CLP) and Travel Plan (TP).
- 9.1.4 The proposed Energy Recovery Facility (ERF) will be capable of efficiently recovering energy stored within waste products. The core elements of the Project include the ERF; carbon capture, utilisation and storage facility; bottom ash and flue gas residue handling and treatment facility; concrete block manufacturing facility; plastic recycling facility; hydrogen production and storage facility; electric vehicle (EV) and hydrogen (H₂) refuelling station; battery storage and hydrogen and natural gas above ground installations (collectively known as 'the Project')
- 9.1.5 A gatehouse and associated weighbridges are proposed at the main entrance to the ERF, which will control HGV and other operational vehicle access. There will also be a visitor centre located adjacent to this, which will provide a secure access to view the ERF from an elevated walkway and will integrate public access to the newly established wetland area.
- 9.1.6 The Project will also include the construction of a new railhead to the south of Flixborough Wharf, with the primary purpose of facilitating the delivery and export of materials to and from the Project to reduce the need for road vehicle movements and to increase capacity which will help to minimise rail movements overnight.

- 9.1.7 In order to facilitate the core elements proposed on the Project, it is proposed to stop up Stather Road from Flixborough Industrial Estate to the existing surface water pumping station situated 160 metres north of Neap House. A New Access Road is proposed between Stather Road and the B1216 Ferry Road West, which is intended to serve both the Project as well as the existing Flixborough Industrial Estate and Flixborough Wharf area.
- 9.1.8 As a result of these stopping up proposals, the existing Bus Route 60 will be diverted along the New Access Road, which has been agreed in principle with NLC. This bus diversion is unlikely to have a significant impact on bus journey times.
- 9.1.9 In addition, it will be necessary to relocate the existing main access to Flixborough Wharf (RMS Trent Ports), which is currently located 250 metres west of Bellwin Drive, to First Avenue via Bellwin Drive, which is currently used as their secondary access point. This has been agreed in principle with RMS Trent Ports as part of the ongoing discussions between the Applicant and RMS Trent Ports.
- 9.1.10 It is also proposed to provide a new layby in the vicinity of the existing surface water pumping station to allow for a full-size articulated vehicle (16.5m in length) to turn around when Stather Road has been stopped up.
- 9.1.11 Highway improvements are proposed on First Avenue at the entrance to Flixborough Wharf to allow for two-way HGV movements, together with the provision of double yellow lines along both sides of First Avenue between Flixborough Wharf and Second Avenue (which is within the RMS Port's ownership) to ensure unrestricted two-way vehicle access.
- 9.1.12 The proposed New Access Road will connect to the B1216 Ferry Road West via a new 3-arm roundabout located approximately mid-way between the A1077 and Neap House Roundabout. At its northern end a new priority junction with ghost island arrangement is proposed to join Stather Road, which ties in with the Bellwin Avenue access. These junction layouts have been agreed in principle with NLC.
- 9.1.13 A new 3m wide shared pedestrian / cycle footway is proposed along the eastern side of the New Access Road, which will extend westbound along Stather Road and connect to the existing footways on Bellwin Drive as well as along the northern side of the B1216 Ferry Road West, connecting westward to Neap House and eastward to the A1077. A new toucan crossing facility is proposed at the A1077 / B1216 Ferry Road West signal junction to enable pedestrians and cyclists to cross the A1077.
- 9.1.14 A new section of 3m shared pedestrian / cycle footway is also proposed along First Avenue between Bellwin Drive and Flixborough Wharf in order to enhance pedestrian /cycle connections in this area.

- 9.1.15 These pedestrian / cycle improvements will improve pedestrian and cycle connectivity at the Project as well as for the surrounding area. It will also seek to encourage the use of public transport travel modes with local bus stops within walking distance and Scunthorpe and Althorpe railway stations within a 20-30-minute cycle ride.
- 9.1.16 It is intended that the New Access Road would be constructed to adoptable highway standards to enable it to form part of the public highway maintained by NLC.
- 9.1.17 The collision analysis shows that the local highway network does not have a significant collision record.
- 9.1.18 It is proposed to provide a total of 78 cycle parking spaces for the core elements proposed on the Project, with 54 secure spaces for employees and 24 sheltered spaces for visitors, which is in accordance with NLC cycle parking guidance. This cycle parking provision allows for a potential increase in employee cycle modes in the future should this be required.
- 9.1.19 The proposed car parking has been provided based on the bespoke operations for the core elements proposed on the Project. A total of 150 car parking spaces are proposed, including 9 disabled parking spaces. This will include a minimum of 3 car parking spaces with electric vehicle charging facilities in accordance with NLC's emerging Local Plan. Provision will also be made for 8 motorcycle spaces.
- 9.1.20 In terms of freight transport, due to the strategic location of the Project adjacent to the River Trent and the freight rail connection, there is an opportunity to adopt river and/or rail-based transport of freight.
- 9.1.21 Options for using these rail/river modes have been explored whilst taking account of any practical constraints and commercial factors and this assessment is contained in the preliminary Navigational Risk Assessment (NRA) and Rail Operations Report (ROR) submitted as part of the DCO application.
- 9.1.22 The Project will include the construction and operation of a new railhead to the south of Flixborough Wharf, with the primary purpose of facilitating the delivery and export of materials to and from the Project to reduce the need for road vehicle movements and to increase capacity which will help to minimise rail movements overnight.
- 9.1.23 For the purpose of the transport assessment, a worst-case (robust) assumption has been adopted, which assumes that all freight would be transported by road during operation. This approach has been agreed in principle with NLC and NH.

- 9.1.24 Freight transport movements associated with the Project are expected to be Heavy Goods Vehicle (HGVs) movements, which take place Monday to Saturday, typically between 06:00 and 20:00.
- 9.1.25 The highway impact assessment has shown that the anticipated increase in traffic on the Strategic Road Network (SRN) is not expected to be significant and below National Highways threshold requirements for further / detailed assessment.
- 9.1.26 The capacity assessment of the proposed improvements at the A1077 / Ferry Road West signal junction, which incorporates a new toucan facility to enable pedestrians /cyclists to cross the A1077, shows that the junction is expected to operate satisfactorily in 2028 and 2033 with development traffic for both the AM and PM peak periods.
- 9.1.27 The proposed junctions at either end of the New Access Road are also expected to operate satisfactorily with ample spare capacity in 2028 (year of opening) and 2038.
- 9.1.28 The impact assessment on local walking, cycling and public transport networks is not shown to be significant.
- 9.1.29 A Travel Plan has been submitted with the planning application, which is an established way to promote and support sustainable travel. The Travel Plan provides an outline of sustainable travel measures tailored to the core elements proposed on the Project together with a plan for implementing and monitoring these measures. It also includes targets to increase public transport use, cycling and walking.
- 9.1.30 An Outline CLP has also been submitted with the application, which includes a number of measures to help mitigate the impact of construction activities, including a traffic management plan to define construction vehicle routes.

9.2 Conclusion

- 9.2.1 Based on the assessment outlined in this report, it is concluded that the proposals fully comply with prevailing transport policy guidance and that the development proposals are appropriate for the location.
- 9.2.2 In conclusion, there are no reasons why the development proposals should not be granted planning permission on transport grounds.

Appendix A National Highways and NLC Scoping Consultation

Jeanne Watrin

From: Natalie Maynard
Sent: 08 February 2021 16:50
To: Richard Evans
Cc: Victoria Lomas; Jeanne Watrin
Subject: FW: NLGEP - SCOPING
Attachments: AA.20.20.03 DevHU0058 TM001 Green Park Flixborough TA Scoping - CH2M Review (JP Issued).pdf

Follow Up Flag: Follow up
Flag Status: Completed

FYI email below – we need to provide a little more explanation to HE (refer to their original response attached) – they require confirmation of the actual increase on the SRN links so they can understand whether there are any increases greater than 30 trips ? (hopefully not)

Can you maybe add this to the table for the SRN (in the next day or so ?) so we can confirm this to back to HE ASAP - thanks

Kind Regards,

Natalie Maynard

Associate
BuroHappold Engineering | City Systems | Transport & Mobility
71 Newman Street, London W1T 3EQ

BURO HAPPOLD



I work Monday/Tuesday/Thursday until 4pm and Wednesday/Friday until 2pm

From: Geoghegan, Simon [REDACTED]
Sent: 08 February 2021 16:18
To: Natalie Maynard [REDACTED]
Cc: Ali, Sunny [REDACTED]
Subject: NLGEP - SCOPING

****External Email. This email originated from outside Buro Happold.****

Natalie

Following your response at the end of last week, I have now spoken with my Transport Consultant, and he comments:

In terms of transparency and scrutiny by wider stakeholders, if Buro Happold are of the opinion that the SRN should not be included within the study area, then it should be included within the reporting for Highways England to review and comment formally. It is noted that the development proposals have been scaled back in terms

of trip generating potential in the peak hours from when Highways England were initially approached for comment through scoping.

Whilst the information provided is useful for high-level considerations of the rationale that Buro Happold have set out in their email, and I appreciate that percentage impact is a measure which tends to be used in Environmental Statement reporting, I would feel uncomfortable coming to a definitive view based on the information provided in said email. As such, our comments in the attached remain valid.

Furthermore, taking the SRN out of the study area may result in construction impacts not being fully considered.

I therefore suggest that you evidence your predicted impact on the SRN in your final report, even if you then conclude that the SRN is not significantly affected. This puts the matter on record and allows Highways England the chance to verify your conclusion. This will be more efficient than having to respond to challenges that may later be made.

Regards

During the Coronavirus Pandemic in common with many of my colleagues I am working from home and no messages should be left on the Lateral Phone Number. My **personal** mobile number is given below but this should only be given out to direct stakeholders with a business need.

Simon Geoghegan, Planning and Development

Highways England | Lateral | 8 City Walk | Leeds | LS11 9AT

Web: <http://www.highways.gov.uk>

This email may contain information which is confidential and is intended only for use of the recipient/s named above. If you are not an intended recipient, you are hereby notified that any copying, distribution, disclosure, reliance upon or other use of the contents of this email is strictly prohibited. If you have received this email in error, please notify the sender and destroy it.

Highways England Company Limited | General enquiries: 0300 123 5000 | National Traffic Operations Centre, 3 Ridgeway, Quinton Business Park, Birmingham B32 1AF | <https://www.gov.uk/government/organisations/highways-england> | info@highwaysengland.co.uk

Registered in England and Wales no 9346363 | Registered Office: Bridge House, 1 Walnut Tree Close, Guildford, Surrey GU1 4LZ

Consider the environment. Please don't print this e-mail unless you really need to.

Jeanne Watrin

From: Louisa Simpson [REDACTED]
Sent: 05 February 2021 10:51
To: Natalie Maynard
Subject: RE: Linc Lakes

****External Email. This email originated from outside Buro Happold.****

Hi Natalie,

Further to our discussions at the start of the week, the emerging new Local Plan ([A New Local Plan | North Lincolnshire Council \(northlincs.gov.uk\)](#)), which will run until 2038, only provides for 3,000 dwellings as part of the Lincolnshire Lakes within the plan period. It is envisaged that the remaining 3,000 will be brought forward in subsequent plan periods, but no timescales have been assigned to these yet. I would therefore recommend that the TA and EIA is based on 3,000 dwellings rather than the full 6,000.

I've now had chance to look at your e-mail regarding traffic flow data and can confirm that I'm happy with the approach used for the uplifted 2020 flows.

Kind regards

Louisa Simpson
Highway Development Services Team Leader
Assets & Infrastructure
North Lincolnshire Council



From: Natalie Maynard [REDACTED]
Sent: 01 February 2021 12:27
To: Louisa Simpson [REDACTED]
Subject: RE: Linc Lakes

Louisa – I spoke to HE and they confirmed that they would have assessed the full 6000 units for the motorway jncs (albeit that it was few years ago now) – he seemed to suggest that when we circulate our table shortly showing the percentage change in traffic on the various links across the network (so we can then agree the study area extent) maybe we should show this in relation to the 100%/6,000 units linc lakes (i.e. beyond 2038) as well as against the more realistic 50% (by 2038) that you've suggested...

Just need to understand how to deal with this from an EIA perspective too (as well as the TA) i.e. should they be assessing the full 100% (6,000) units for Linc Lakes or just the reduced 3,000 you suggest (or is this just for the highway capacity assessment ?)...hopefully your email will confirm

Kind Regards,

Natalie Maynard
Associate
BuroHappold Engineering | City Systems | Transport & Mobility

71 Newman Street, London W1T 3EQ



BURO HAPPOLD



I work Monday/Tuesday/Thursday until 4pm and Wednesday/Friday until 2pm

From: Natalie Maynard

Sent: 01 February 2021 11:51

To: Louisa Simpson

Subject: Linc Lakes

Hi Louisa – following our call this morning, when you send across your note, it would be useful to understand as part of this whether the assessment work that Linc Lakes have done for HE in relation to the motorway junctions included for 'up to 3000 units' only or whether they also did a horizon year assessment with the full 6,000 units ? i.e. has the new roundabout / their access junctions been designed to cater for the full 6,000 units / or just 3,000 ?

Kind Regards,

Natalie Maynard

Associate

BuroHappold Engineering | City Systems | Transport & Mobility

71 Newman Street, London W1T 3EQ



BURO HAPPOLD



I work Monday/Tuesday/Thursday until 4pm and Wednesday/Friday until 2pm

COVID-19 Update

The majority of Buro Happold employees are working remotely. We remain fully operational and committed to client delivery during this time. We use Teams and, where possible, will conduct meetings via this tool whilst we are working remotely. Office landlines are continuing to operate but may be busy so please use email wherever possible. If you need to speak directly to a member of our team, please continue to use their work mobile numbers, if available.

This transmission is confidential and intended solely for the person or organisation to whom it is correctly addressed. If you are not the intended recipient of this transmission, you should not take any action in reliance on it. Further, this transmission may contain confidential design and other information owned by Buro Happold Ltd. You should not copy, distribute, use, offer for sale or hire such information or in any way infringe the design and intellectual property rights of Buro Happold Ltd. It is intended that communication by email from Buro Happold Ltd or its employees is limited to communications connected to the services provided by Buro Happold Ltd. Buro Happold Ltd accepts no liability for any communications not connected to the services it provides. Computer viruses may be transmitted or downloaded onto your computer system via email communication. It is the recipient's responsibility to take any action necessary to prevent computer viruses being transmitted in this way. Accordingly, Buro Happold Ltd disclaims all responsibility which arises directly or indirectly from such transmission of computer viruses. Buro Happold Ltd. Registered in England: 2049511.

This e-mail expresses the opinion of the author and is not necessarily the view of the Council. Please be aware that anything included in an e-mail may have to be disclosed under the Freedom of Information Act and cannot be regarded as confidential. This communication is intended for the addressee(s) only. Please notify the sender if received in error. All Email is monitored and recorded.

Jeanne Watrin

From: Natalie Maynard
Sent: 11 January 2021 13:38
To: Louisa Simpson
Cc: Jeanne Watrin; Richard Evans; Geoghegan, Simon; Parsons, Jonathan/UWA
Subject: NLGEP - Review of Baseline Traffic Flow Data
Attachments: 046658 Table BH1.pdf; 210111_DfT AADT Flow Comparison.pdf; 210111_Derivation of TEMPRO Factors.pdf

Follow Up Flag: Follow up
Flag Status: Completed

Hi Louisa/Simon,

We have reviewed the pre-COVID traffic flow data for the A1077 / Ferry Road West / B1216 Ferry Road West Signal Junction and the A1077 / Holyrood Drive / Lunenburg Way roundabout and have compared this with the traffic survey data obtained in October 2020 - I attach a summary table (Table BH1) for your review and confirm the methodology used below:

Methodology

Pre-COVID Traffic Survey Data provided by NLC (dated 2014 and 2015)

Pre-COVID Traffic Survey data has been provided by NLC for the A1077 / Ferry Road West / B1216 Ferry Road West Signal Junction (Sky High survey dated 2014) and the A1077 / Holyrood Drive / Lunenburg Way roundabout (2015 survey data contained in Local Transport Projects TA).

This data has been used for comparison with the BH 2020 survey data.

It is noted that whilst 2019 traffic flow data was provided for the A1077 / A18 / M181 junction, this information was incomplete (no data available for the AM peak) and has therefore been excluded from this study.

Traffic Growth (2014/2015 to 2019)

In order to growth the 2014 and 2015 traffic survey data provided for these junctions, TEMPRO growth factors have been extracted for this area. The flow factors used are shown in the attached Table BH1 - the TEMPRO calculations are also attached for your information.

It is noted that the TEMPRO factors extracted for 2014 to 2019 are lower than the ones derived for 2015 to 2019 but this has been reviewed / checked within TEMPRO and is confirmed as being correct.

Comparison of Pre-COVID (2019) flows with 2020 flows

Table BH1 attached shows a comparison of the 2020 flow data obtained at both junctions by BH, compared with the pre-COVID 2019 flow data.

The data shows that the 2020 count data is lower when compared to the 2019 uplifted flows – Table BH1 attached shows the percentage difference together with an equivalent uplift factor – it also shows the average AM/PM factors derived from both sets of data (shown in blue), which are summarised in the table below.

	AM	PM
Proposed factors to be applied to 2020 traffic count data	1.196	1.155

For comparison, we have also looked at the 2019 AADT flows available at the nearby DfT sites and compared this with our 2020 AADT flows (see attached) - it indicates that the daily flows from our 2020 count are around 15% less than the 2019 (pre-COVID) data. This concurs with the assessment carried out above.

In order to bring the baseline traffic data in line with pre-COVID conditions, we propose to apply the factors shown above in blue to our 2020 traffic count data in order to give us '2020 Uplifted Baseline' traffic flows, which subject to your approval, will be used to represent the agreed (2020) baseline flows for our transport/environmental assessment work.

Please confirm this would be acceptable ?

Also, just to give you an update in terms of the flood assessment work that was ongoing when we had our scoping meeting in December 2020, I can confirm that the proposed development on the remainder of the NLGEP site (i.e. not forming part of this DCO application but separate planning application (s) in the future), will now include vertical farming/glasshouse development only and will not include a business park. I understand that the size of the vertical farming/glasshouse development is also being reduced (from that currently set out in the TA Scoping Study) but we await confirmation of the maximum parameter to adopt for the purpose of our assessment - we will confirm this to you shortly.

As you will appreciate, removal of the business park will significantly reduce the trip generation associated with this element of the proposals. It is therefore proposed to carry out junction capacity assessments within the DCO Study Area only (as shown on Figure 6.1 in the TA Scoping Report). Once the above baseline traffic flow data has been agreed, we intend to send you a summary table showing the anticipated change in traffic on the various road links (including the motorway slip roads for Highways England)

I trust the above is acceptable but should you have any queries please don't hesitate to contact myself or Jeanne Watrin.

Kind Regards,

Natalie Maynard

Associate

BuroHappold Engineering | City Systems | Transport & Mobility
71 Newman Street, London W1T 3EQ



I work Monday/Tuesday/Thursday until 4pm and Wednesday/Friday until 2pm

Jeanne Watrin

From: Natalie Maynard
Sent: 11 February 2021 17:04
To: Louisa Simpson
Cc: Jeanne Watrin; Victoria Lomas; Richard Evans
Subject: NLGEP DCO - TA Scope and Site Access discussion
Attachments: 210211_BH Site wide Indicative plan.pdf

Hi Louisa,
Thank you for your time earlier to discuss the site access proposals for the site.

I set out my notes below from today's meeting:

- Buro Happold (BH) presented the highway proposals set out in our design note (sent to NLC on Monday 8th February) and discussed how this ties in with the on-site proposals for the various elements of the DCO application – the plan attached to this email was also presented for discussion, to indicate the intended route of the New Link Road through the site – it also indicates the possible location of the future TCPA elements (comprising glasshouse and vertical farming)
- Louisa (NLC) confirmed that the New Link Road (NLR) connections to the highway - at the northern end via Stather Road and at southern end via a new roundabout on the B1216 are acceptable in principle. NLC confirmed that whilst there may be comments from their highways engineer in due course, she would expect that these would be design-related, which can be accommodated as the design progresses.
- BH discussed the shared footway proposals along the NLR and the proposed connection to Neap House and to Ferry West Road via the A1077, which includes a new toucan crossing facility at the A1077 / B1216 signal junction. NLC confirmed that these proposals look reasonable and based on a preliminary review of the LINSIG analysis results, agreed that the junction would appear to operate satisfactorily in the future situation with this toucan crossing in place.
- BH discussed the aspiration to possibly extend the shared footway along the A1077 eastwards to Skippingdale Roundabout – with a view to enhancing connections to/from the NCN Route 169 (located further east) - NLC confirmed that she would like to speak to her colleagues regarding this as she's not sure whether it would be desirable to provide a new footway at this location given the traffic volumes /HGV movements etc along the A1077 – NLC confirmed that there is an existing pedestrian /cycle connection to/from this NCN Route 169, which is located just south of the A1077, to the south of an existing industrial unit (OSI Food Solutions) which connects to/from Luneburg Way - pedestrians/cycles could potentially use this, together with the existing residential streets (quiet routes) to connect to Ferry West Road to the west – which may be more preferable to the A1077 - NLC will discuss this further with her colleagues and come back to BH on this
- BH briefly discussed the existing PRowS surrounding the site and the aspiration to possibly extend this east-west across the NLR to enhance connections in the area and provide a link to the riverside – NLC suggested that we make contact with Colin Wilkinson () to discuss this further
- BH then went on to discuss the traffic data / study area for the TA – confirming that NLC had agreed the approach proposed by BH for the 2020 uplifted flows to bring the baseline traffic data in line with pre-COVID conditions (BH email dated 11th January and NLC email dated 5th February) and that BH had sent across confirmation of the proposed study area for the TA (based on the percentage change in traffic anticipated on the various road links - BH email dated 5th February) – BH asked NLC if she was happy with the suggested Study Area and NLC confirmed it was acceptable
- In light of the above, BH queried whether NLC would now be in a position to submit a formal Scoping Response to confirm our agreement of the various items confirmed above – NLC confirmed

that she was in the process of doing this and hopes to send it to BH W/E 5th March - NLC confirmed that it should include any comments received from the highways engineer / other NLC depts

I trust I have covered everything above but please do let me know if I've missed anything

Enjoy your week off next week ☺

Kind Regards,

Natalie Maynard

Associate

BuroHappold Engineering | City Systems | Transport & Mobility

71 Newman Street, London W1T 3EQ



BURO HAPPOLD



I work Monday/Tuesday/Thursday until 4pm and Wednesday/Friday until 2pm

Jeanne Watrin

From: Louisa Simpson [REDACTED]
Sent: 08 April 2021 08:08
To: Natalie Maynard
Cc: Jeanne Watrin
Subject: North Lincs Green Energy Park - Scoping Report

Follow Up Flag: Follow up
Flag Status: Completed

****External Email. This email originated from outside Buro Happold.****

Hi Natalie,

I am writing to confirm that I am happy with the proposed approach set out in the Scoping Report.

I appreciate that you don't have full details of AILs at the moment and this is quite common. Your proposed suggestion to confirm that appropriate legislation will be followed and discussions held with the relevant authorities at the appropriate time is acceptable. This is something that I would expect a Construction Phase TMP to pick up in more detail.

With regards to the M181, the northern junction is nearing completion and as I understand it, HE will then progress the de-trunking the section of the M181 north of this junction. Work should start on the southern terminating junction later in 2021/22 and once this is completed, then the remainder of the M181 north of this junction will be de-trunked. I'm not entirely certain on the timescales for de-trunking as they are a bit vague at the moment but it is anticipated that the formal process for de-trunking for each section could take 12 – 18 months.

Kind regards

Louisa Simpson
Highway Development Services Team Leader
Assets & Infrastructure
North Lincolnshire Council

This e-mail expresses the opinion of the author and is not necessarily the view of the Council. Please be aware that anything included in an e-mail may have to be disclosed under the Freedom of Information Act and cannot be regarded as confidential. This communication is intended for the address(es) only. Please notify the sender if received in error. All Email is monitored and recorded. Please think before you print- North Lincolnshire Council greening the workplace.

Jeanne Watrin

From: Louisa Simpson [REDACTED]
Sent: 29 January 2021 13:45
To: Natalie Maynard
Cc: Jeanne Watrin
Subject: RE: A1077 Phoenix Parkway / B1216 Ferry Road West staggered junction

****External Email. This email originated from outside Buro Happold.****

Hi Natalie,

Sorry I've missed your calls.

There are no proposals for any improvements to the A1077/B1216 junction as part of the Lincolnshire Lakes proposals.

The signals were installed by NLC in 2015/16, primarily as a local safety scheme as there had been a significant number of accidents involving HGVs. The original intention was to construct a roundabout in this location as part of a large housing development which was proposed to the east of the A1077, between the A18 and B1216. This development never came forward and I believe the permission has now expired. The Lincolnshire Lakes assessments were carried out prior to the signalised junction being installed.

The proposals for the Lincolnshire Lakes have been amended over the last few years. Although the long-term aspiration is still to provide 6,000 houses, the emerging New Local Plan only provides provision for approximately 3,000 new dwellings before 2038. It is anticipated that the remaining dwellings will be constructed after 2038.

I hope this provides some clarity.

I'm around until 3pm today but otherwise should be available most of Monday if you want to have a quick chat.

Kind regards

Louisa Simpson
Highway Development Services Team Leader
Assets & Infrastructure
North Lincolnshire Council



From: Natalie Maynard [REDACTED]
Sent: 29 January 2021 08:22
To: Louisa Simpson [REDACTED]
Cc: Jeanne Watrin <[REDACTED]>
Subject: RE: A1077 Phoenix Parkway / B1216 Ferry Road West staggered junction

Hi Louisa – hope you're well - we're currently finalising our preliminary analysis for the proposed access arrangements for the new access road (particularly at the southern end with the B1216 / A1077), which we're under pressure to get across to you as soon as possible for discussion, with a view to obtaining your

agreement in principle in the next couple of weeks. Essentially so that we have a fixed option to take forward for our detailed assessments.

As part of this, we would welcome your feedback regarding Jeanne's query below ? Feel free to give me a call to discuss – I'm around all morning today until about 1230 if that's good for you...

We're basically keen to understand whether Lincolnshire Lakes are proposing any improvements at the B1216 / A1077 signal junction as part of their proposals ?

From my understanding of the information we have found so far, it appears that the signals were installed around 2015/2016 (by NLC ?) as there were issues with the previous priority junction (over capacity / accident problem etc) but our preliminary analysis is showing that the large volume of traffic generated by Linc Lakes will topple this signal junction in the future (2026 onwards - over capacity / large queues) so we were wondering if Linc Lakes had found this too as part of their work and therefore proposed some form of improvement ? they appear to have assessed the priority junction pre-2015 and suggested a roundabout improvement but we couldn't seem to find anything else / more up-to-date in relation to the signals

Hopefully speak to you later today

Kind Regards,

Natalie Maynard

Associate

BuroHappold Engineering | City Systems | Transport & Mobility

71 Newman Street, London W1T 3EQ

[Redacted]

[Redacted]

BURO HAPPOLD



I work Monday/Tuesday/Thursday until 4pm and Wednesday/Friday until 2pm

From: Jeanne Watrin [Redacted]
Sent: 28 January 2021 16:58
To: Louisa Simpson [Redacted]
Cc: Natalie Maynard [Redacted]
Subject: A1077 Phoenix Parkway / B1216 Ferry Road West staggered junction

Good afternoon Louisa,

I have tried to call you but the calls don't seem to go through unfortunately.
Could you call me back when you are free, [Redacted]

This is in regards to the staggered junction between A1077 Phoenix Parkway and B1216 Ferry Road West. We would like to know when the junction was improved as well as the reason why it the improvements were required. We have found a programme of works from NLC (attached) which seems to indicate that the works were put forward as part of a Local Safety Scheme – has there been any feasibility study and/or modelling undertaken before the signalisation of the junction? Or was the junction improvements included as a result of a nearby development?

Kind regards,
Jeanne

Jeanne Watrin MSc MTPS MCIHT

Jeanne Watrin

From: Louisa Simpson [REDACTED]
Sent: 22 January 2021 14:26
To: Jeanne Watrin
Cc: Victoria Lomas
Subject: RE: NLGEP - Committed Developments
Attachments: Proposed Residential and Employment Developments, Scunthorpe STA Final Issue 1.pdf

****External Email. This email originated from outside Buro Happold.****

Hi Jeanne,

I've added some comments in red in the table below, which may or may not be helpful!

The only other committed developments that should be considered are the Lincolnshire Lakes northern section (PA/2013/1000 and PA/2013/1001). The permissions have lapsed but the aspiration remains for this development to come forward.

I'm happy with the proposed approach to calculating trip rates, where no information currently exists.

Kind regards

Louisa Simpson
Highway Development Services Team Leader
Assets & Infrastructure
North Lincolnshire Council



From: Jeanne Watrin [REDACTED]
Sent: 22 January 2021 11:37
To: Louisa Simpson [REDACTED] >
Cc: Victoria Lomas [REDACTED]
Subject: NLGEP - Committed Developments

Good morning Louisa,

As part of the TA scoping note, we had included a list of the committed developments we are proposing to include within our cumulative assessment / future baseline.

The list of committed developments is the following:

Name	Reference	Type of Development	Forecast Year	Status
Lincolnshire Lakes	PA/2017/1386; PA/2015/0628	Residential	Highway works have commenced – development due to be	Under Construction. Permission granted for

			complete by 2028	PA/2017/1386 – work due to start in 2021. Permission not yet granted for PA/2015/0628 – awaiting agreement of the S106.
Glanford Park Football Stadium extension	PA/2018/1388, PA/2018/1389, PA/SCR/2018/10	Stadium and Residential	Unknown	Unknown Permission granted. Unknown when work will start. Residential is outline permission.
Land off Jack Brownsword Way	PA/2020/660	Mixed-Use Development	2024 opening year; 2025 design year	Unknown TA submitted with the application.
Normanby Enterprise Park	PA/2020/1115; PA/2020/1595; PA/2020/113	Industrial	Unknown	Unknown. A TA was produced to support the original application in 2015 (see attached)
Land at the Glebe	Screening opinion (Ref.: SCR/2020/2)	Residential	Unknown	Unknown No application has been submitted yet.
Land Off, Burringham Road, Ashby Parklands, Scunthorpe	PA/2020/1333	Residential	2024 base	Unknown. A TA was submitted with the planning application.
Land off Normanby Road (adjacent Conesby Quarry), Scunthorpe	PA/SCR/2020/8	Industrial	Unknown	EIA Screening

Could you let us know whether we should include others?

Some of the committed developments have limited information, for example the Land at the Glebe is a Housing Land Allocation and has no TA / trip generation / trip distribution data.

We are proposing to obtain trip rates from TRICS and distribute them onto the network using the observed turning count data percentages.

Could you let us know whether that is acceptable?

Kind regards,
Jeanne

Jeanne Watrin MSc MTPS MCIHT

Appendix B Collision Data

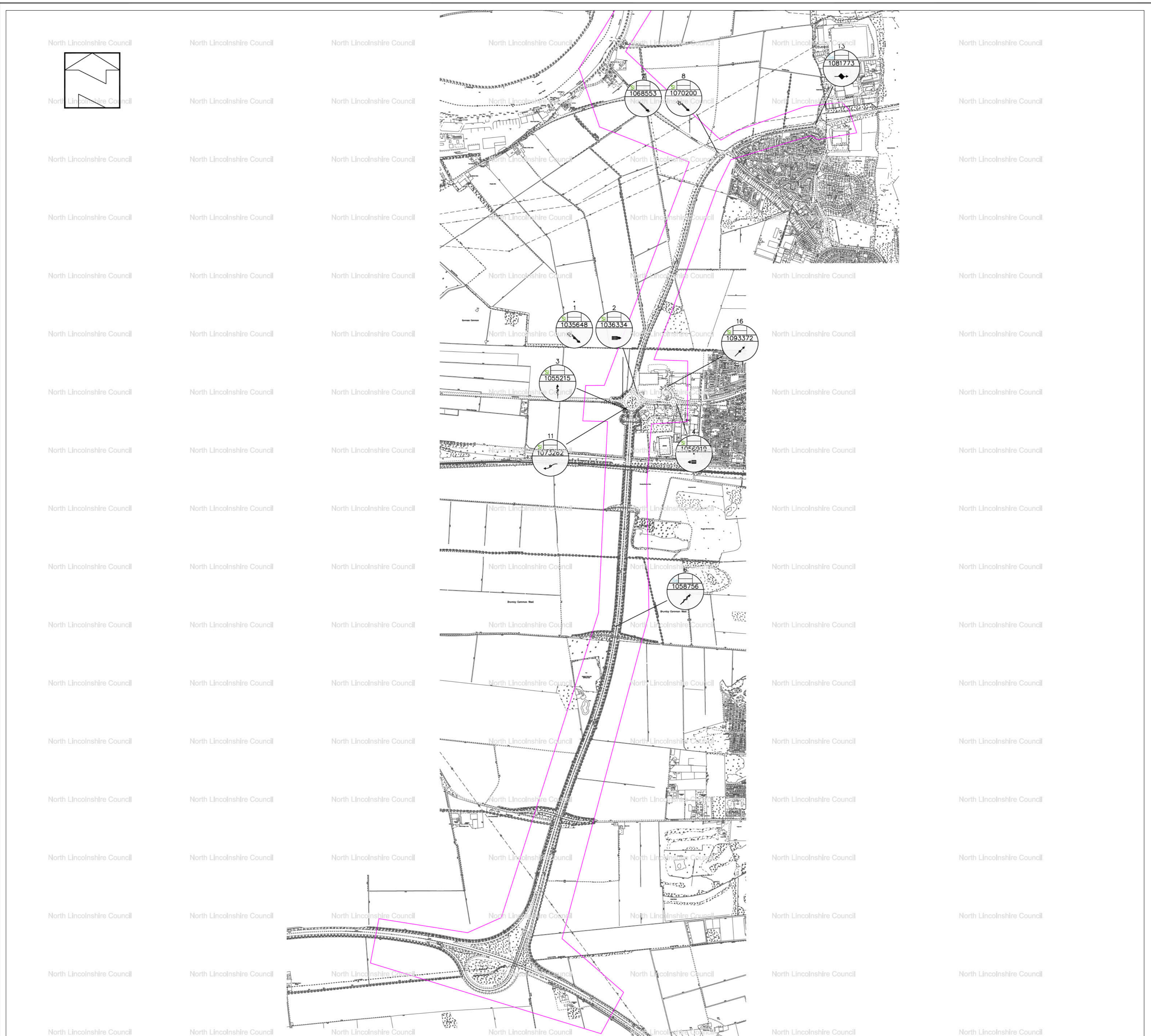

Reference Number	1035 648	1036 334	1055 215	1056 919	1058 756	1068 553	1070 200	1073 262	1081 773	1093 372	
Date / Day	We14	Fr16	Su13	We16	Tu22	Fr18	We14	Fr09	Sa28	We08	
Month	Apr	Apr	Jun	Jun	Jun	Jun	Jul	Jul	Aug	Sep	
Year	2021	2021	2021	2021	2021	2021	2021	2021	2021	2021	
Time	0558	1140	0727	1625	0754	1730	1727	1036	0640	1445	
Severity	SI	SI	SI	SI	Se	SI	SI	SI	Se	SI	
Dark / Lit											
Weather Conditions											
Road Surface											
Special Conditions											
Carriageway Hazards											
Vehicle Manoeuvres											
Vehicle	1 5 e	32 34	45 48	48 48	55 55	31 31	77 77	54 54	24 24	33 33	
Vehicle	2 6 t	34 34	48 48	48 48	55 55	31 31	77 77	54 54	24 24	33 33	
Vehicle	3 7 c	34 34	48 48	48 48	55 55	31 31	77 77	54 54	24 24	33 33	
Vehicle	4 8	34 34	48 48	48 48	55 55	31 31	77 77	54 54	24 24	33 33	
Casualty /age											
Failed to Give-Way											
Signal Ignored											
Loss of Control											
Hit Object IN C'way											
Hit Object OFF C'way											
Vehicle Left C'way											
Breath Test											
Contributory Factors	1/2	V1 *C1 * 405 999	V2**V2** 406 308	V1** 602	V1** 706	V1 *V1 * 405 410	V2**V2 * 308 405	V1 * 406	V1** 405	V2**V1** 706 701	V2 *V2 * 308 405
	3/4										
* possible, ** very likely	5/6										
School No./Ref.	1										
User Fields	2										
	3										
	4										

REV	DETAILS	APPROVED BY	DATE APPROVED

North Lincolnshire Council Head of Service Assets and Infrastructure, Operations Chris Ramsbottom	Based upon the Ordnance Survey mapping with the permission of Ordnance Survey on behalf of the Controller of Her Majesty's Stationery Office, © Crown Copyright. Unauthorized reproduction infringes Crown Copyright and may lead to prosecution or civil proceedings. NORTH LINCOLNSHIRE COUNCIL 2018 0100023500	
	DRAWING TITLE Injury Related Accident Data (14.01.2021 to the 10.09.2021)	
	DRAWN BY PROJECT TITLE	SCALE DRAWING NUMBER

The Ordnance Survey map data included with this publication is provided by North Lincolnshire Council under license from Ordnance Survey in order to fulfill its public function to act as a planning authority. Persons viewing this mapping should contact Ordnance Survey copyright for advice where they wish to license Ordnance Survey map data for their own use.

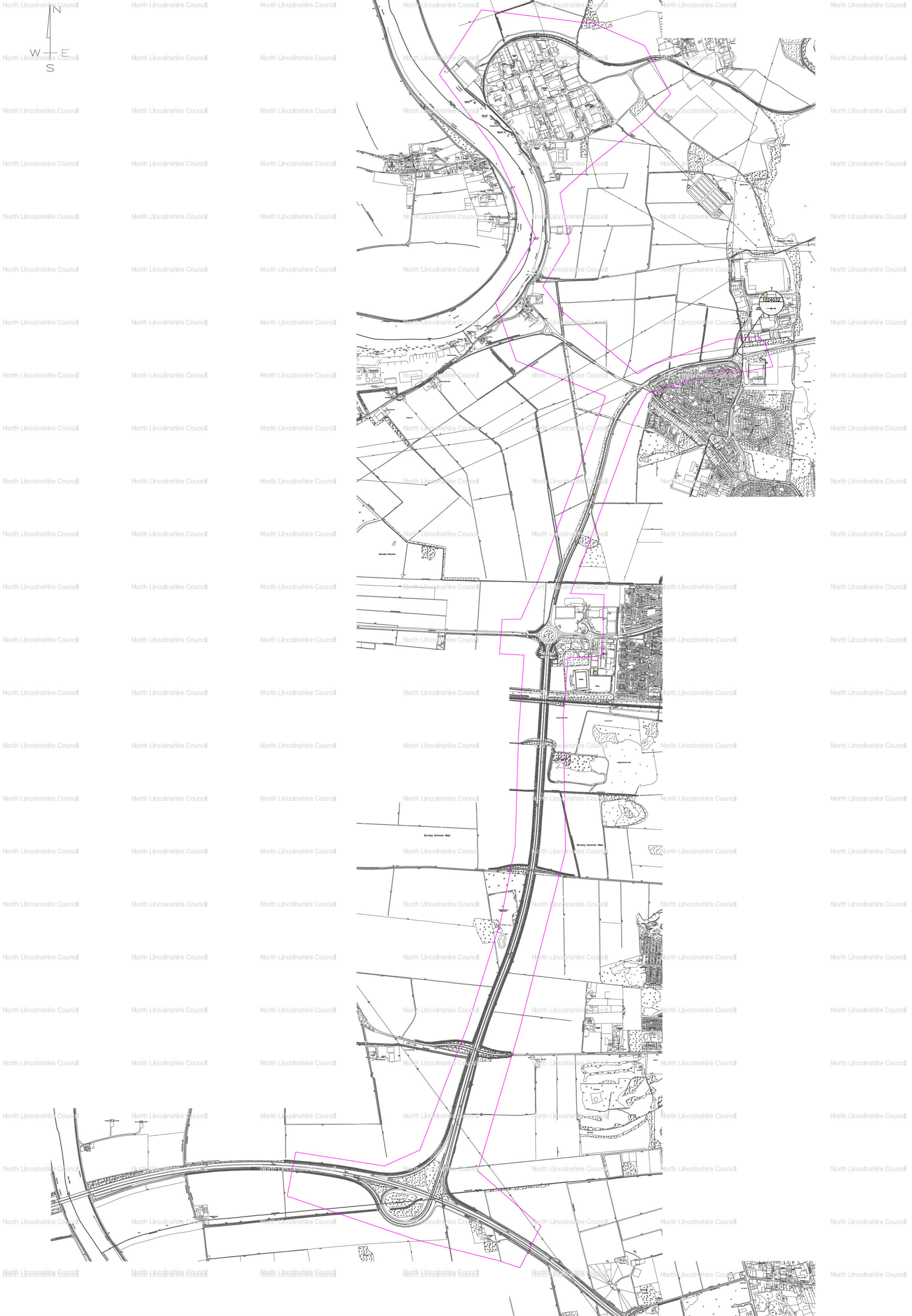
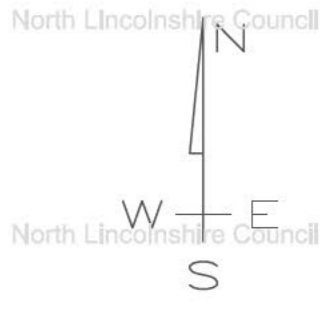

REV	DETAILS	APPROVED BY	DATE APPROVED
North Lincolnshire Council Head of Service Assets and Infrastructure, Operations Chris Ramsbottom		Based upon the Ordnance Survey mapping with the permission of Ordnance Survey on behalf of the Controller of Her Majesty's Stationary Office. © Crown Copyright. Unauthorised reproduction infringes Crown Copyright and may lead to prosecution or civil proceedings. NORTH LINCOLNSHIRE COUNCIL 2018 010023560	
DRAWING TITLE 5 Years Injury Related Accident Data (14.01.2021 to the 21.03.2021)			
DRAWN BY	SCALE	CHECKED BY	DATE CHECKED
PROJECT TITLE		DRAWING NUMBER	REV
<small>The Ordnance Survey map data included within this publication is provided by North Lincolnshire Council under license from Ordnance Survey in order to fulfil its public function to act as a planning authority. Persons viewing this mapping should contact Ordnance Survey copyright for advice where they wish to reuse Ordnance Survey map data for their own use.</small>			

Appendix C Traffic Flow Diagrams

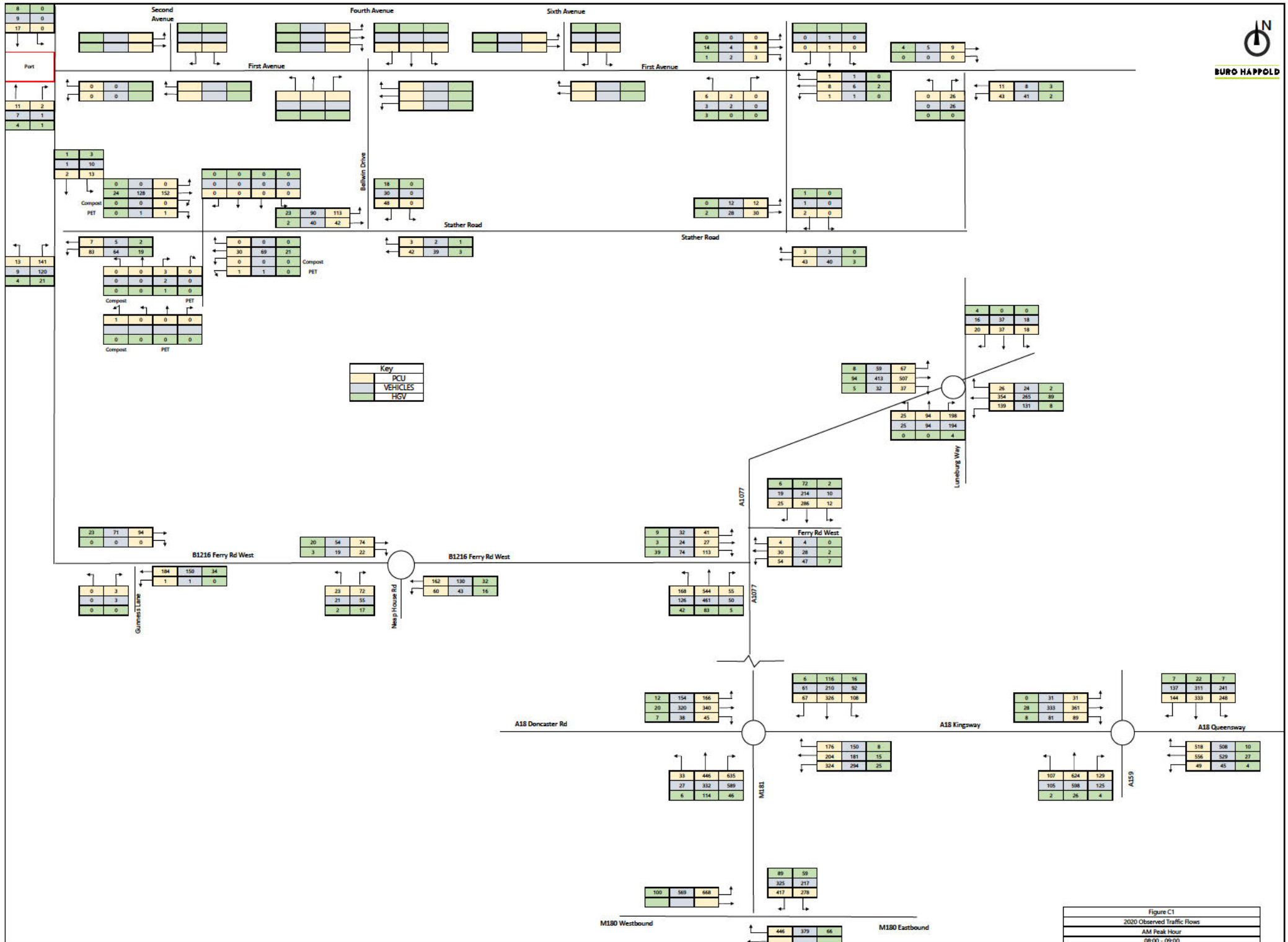

Key		
	PCU	
	VEHICLES	
	HGV	

Figure C1
 2020 Observed Traffic Flows
 AM Peak Hour
 08:00 - 09:00

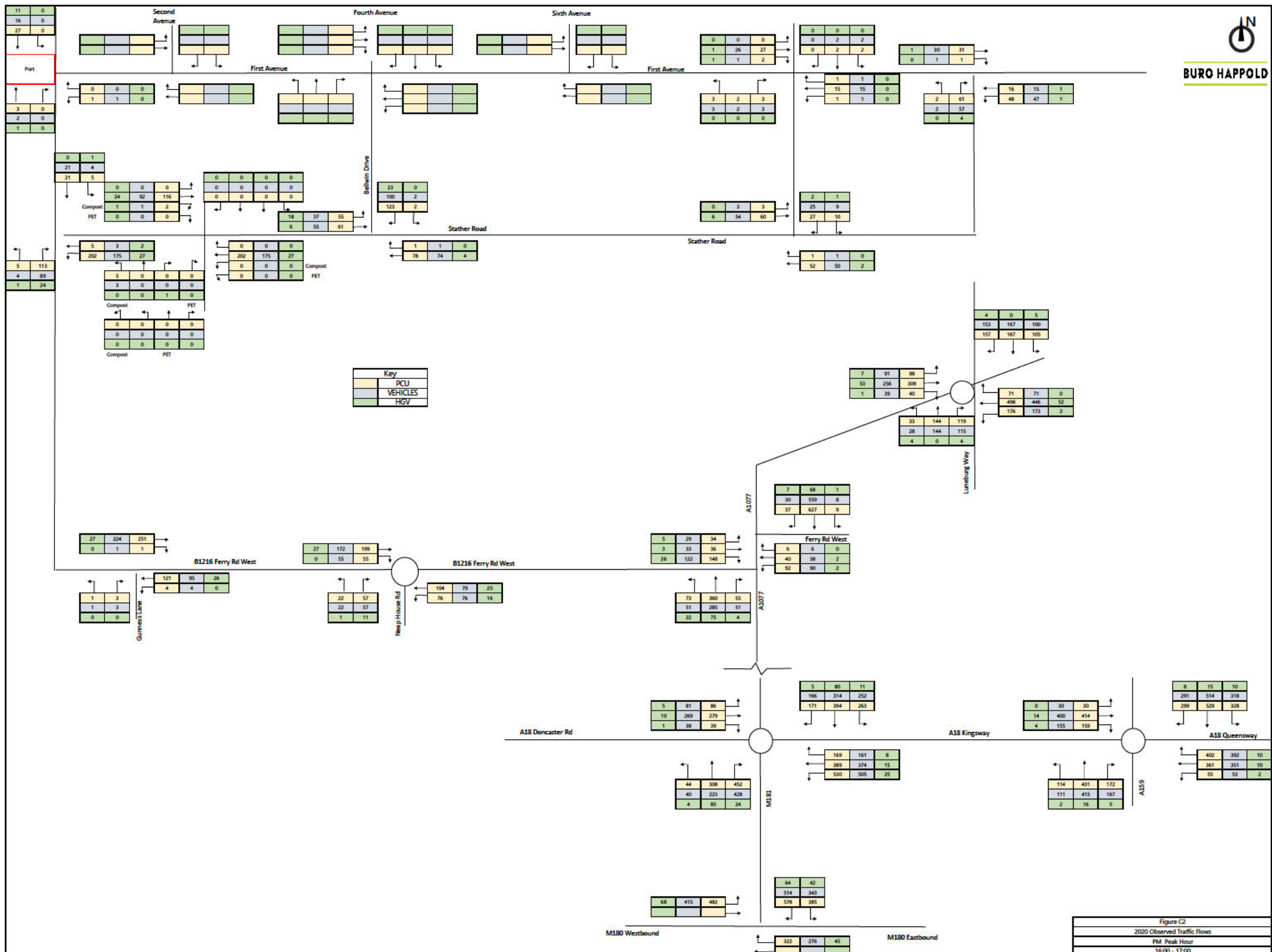

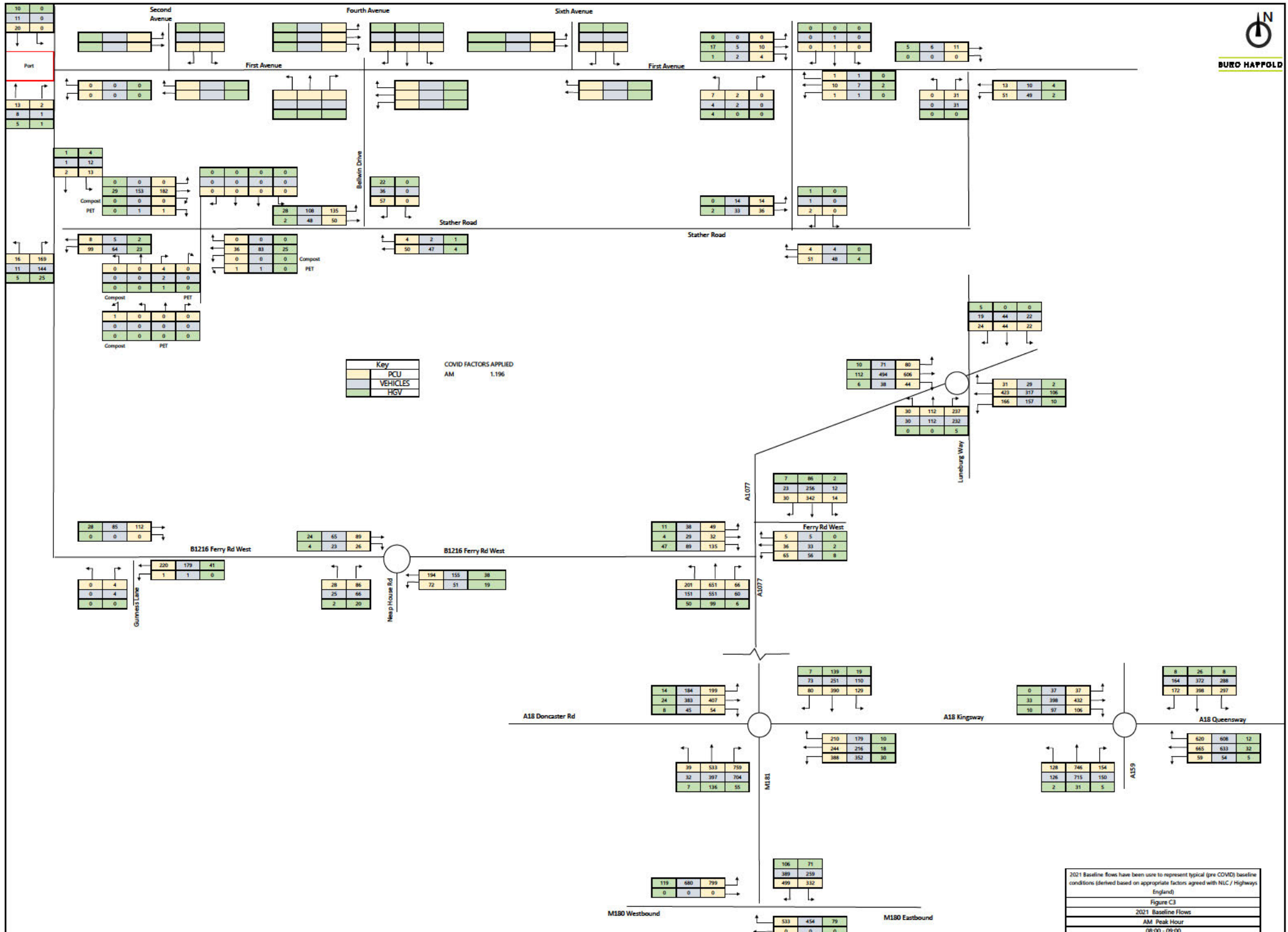

Key
 PCU
 VEHICLES
 HGV

COVID FACTORS APPLIED
 AM 1.196

2021 Baseline Flows have been used to represent typical (pre COVID) baseline conditions (derived based on appropriate factors agreed with NLC / Highways England)
 Figure C3
 2021 Baseline Flows
 AM Peak Hour
 08:00 - 09:00

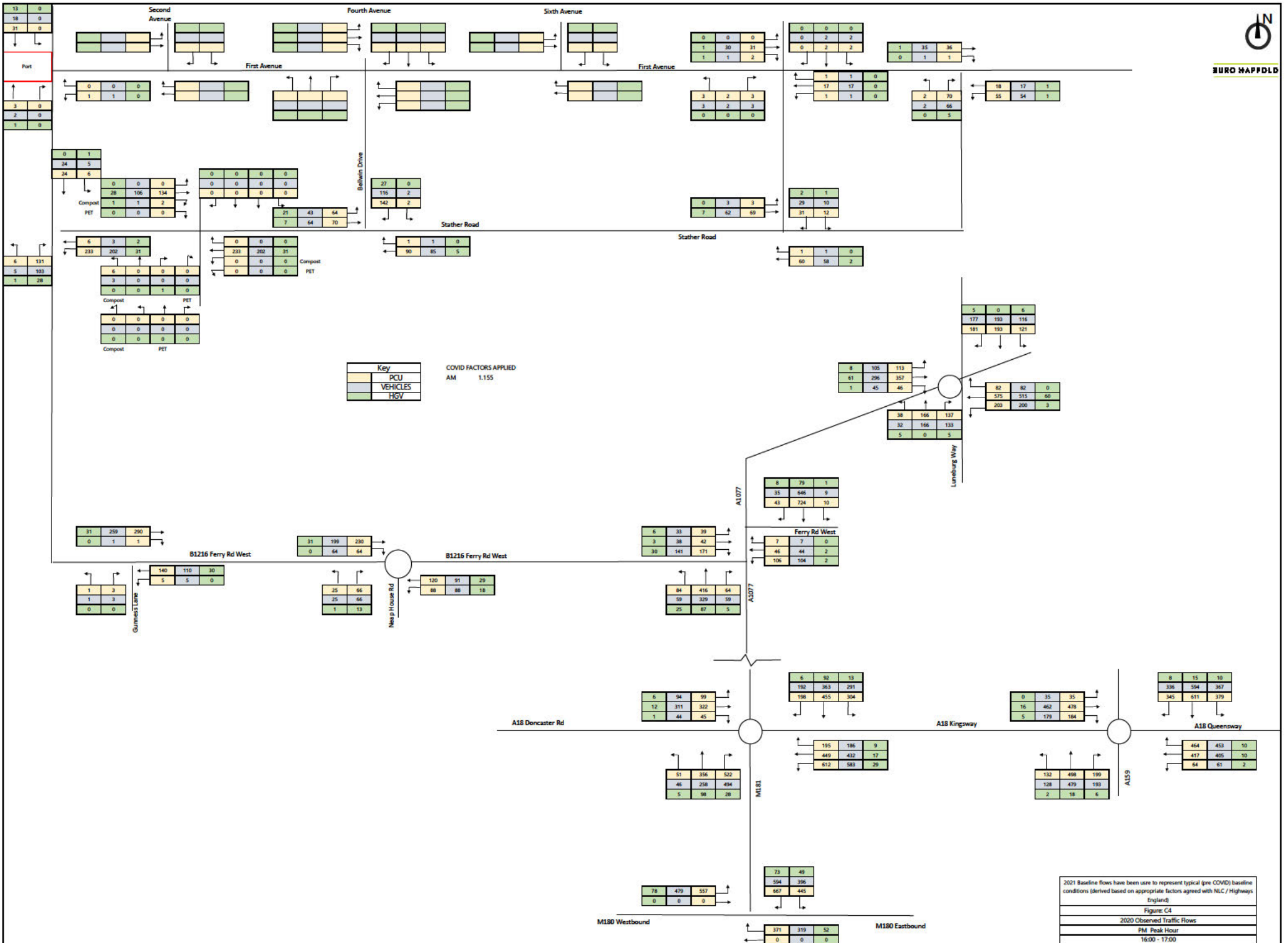

Key		
	PCU	
	VEHICLES	
	HGV	

COVID FACTORS APPLIED
AM 1.155

2021 Baseline flows have been used to represent typical (pre COVID) baseline conditions (derived based on appropriate factors agreed with NLC / Highways England)
Figure: C4
2020 Observed Traffic Flows
PM Peak Hour
16:00 - 17:00

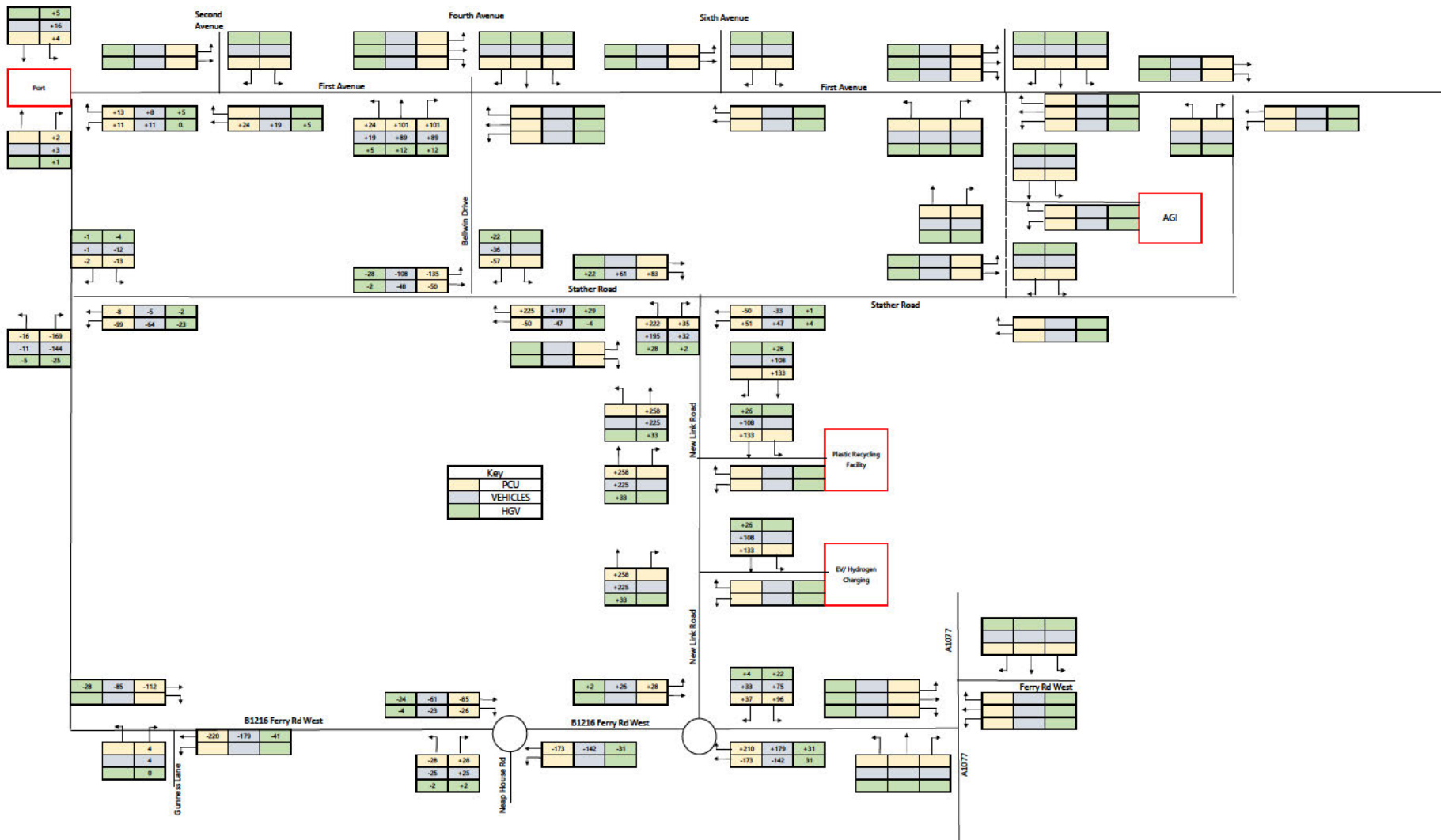

Figure C5a
 Stather Road Stopping Up Redistribution of traffic
 AM Peak Hour
 08:00 - 09:00

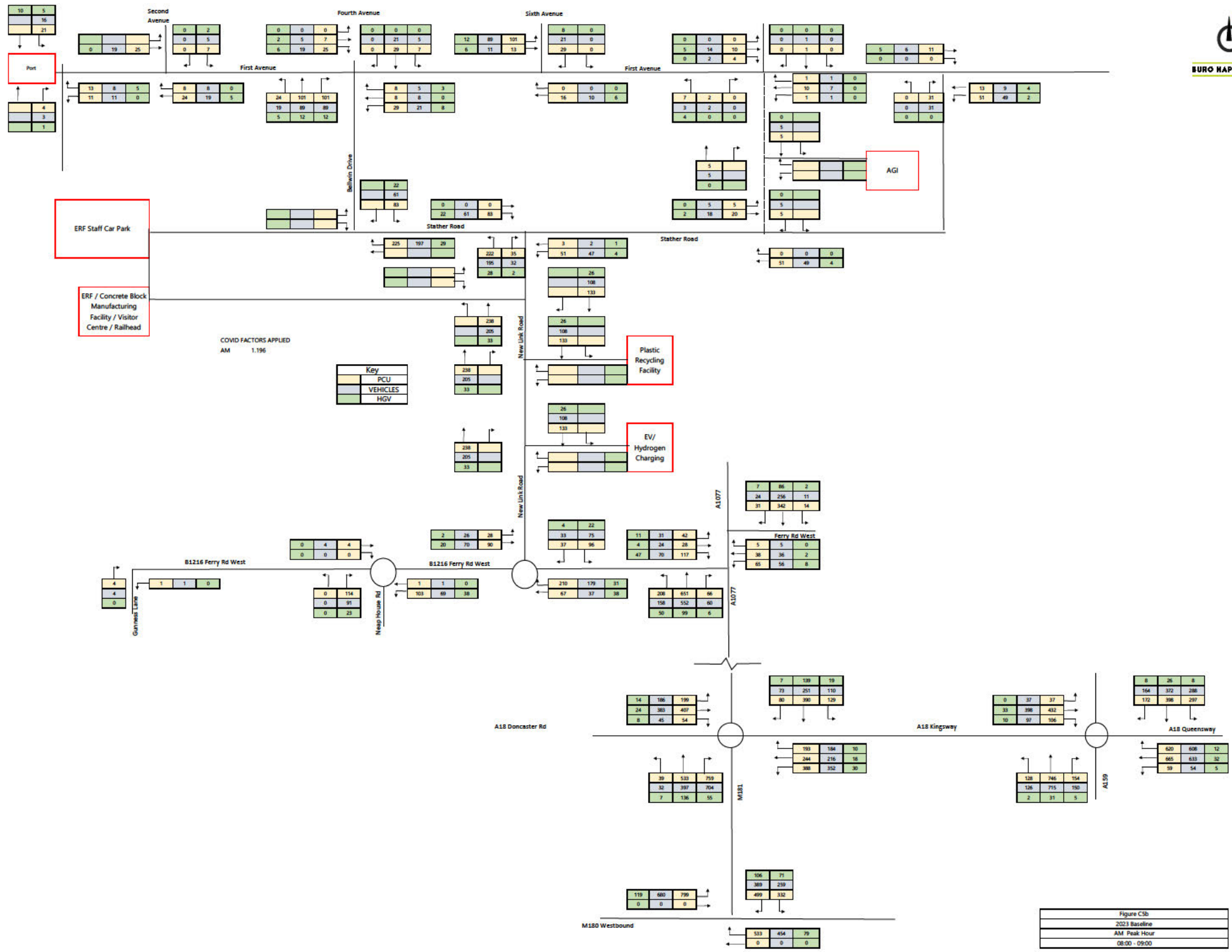
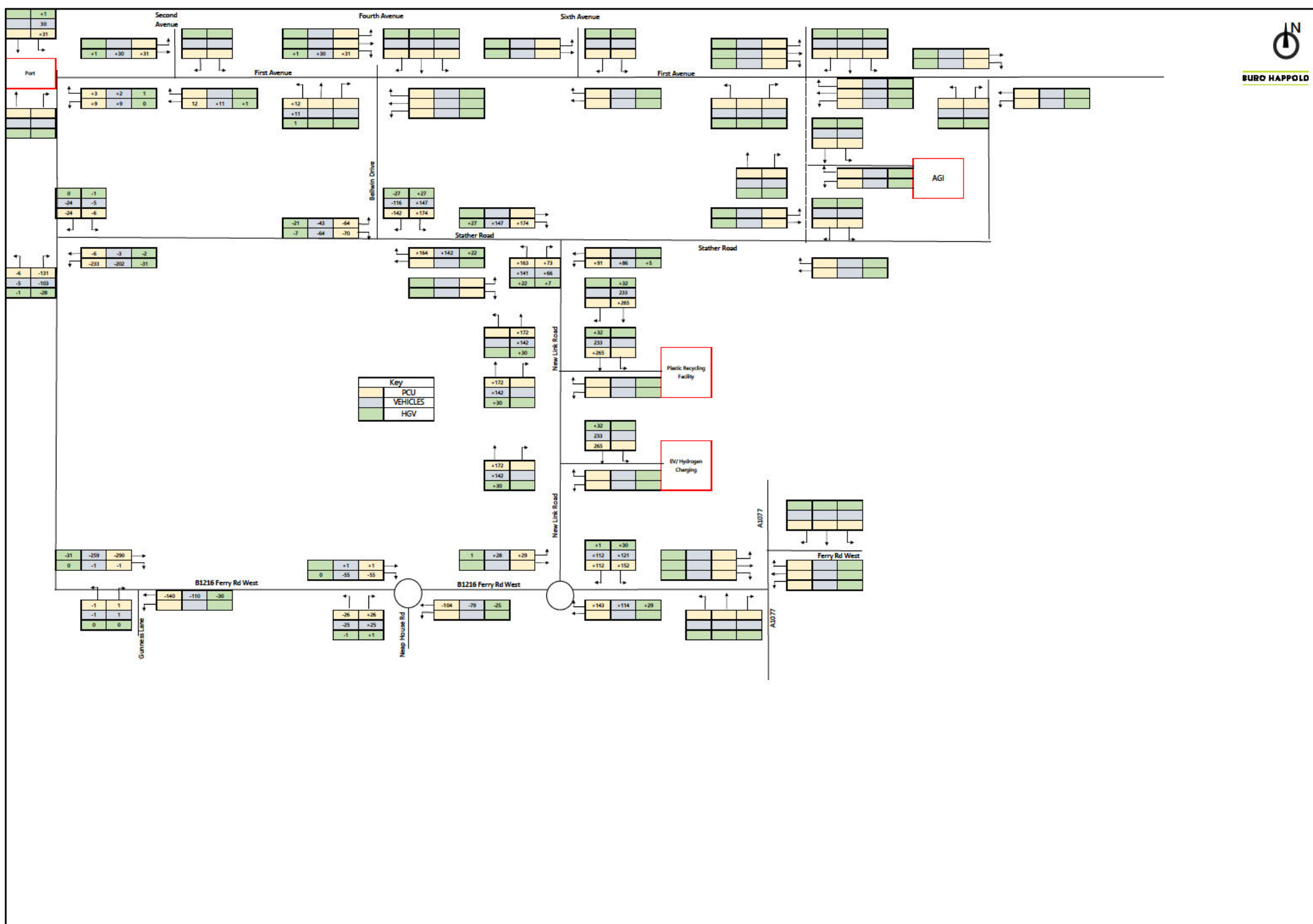

Figure C5b
2023 Baseline
AM Peak Hour
08:00 - 09:00



Key		
	PCU	
	VEHICLES	
	HGV	

Figure C6a
Stather Road Stopping Up Redistribution of traffic
PM Peak Hour
16:00 - 17:00



BURO HAPPOLD

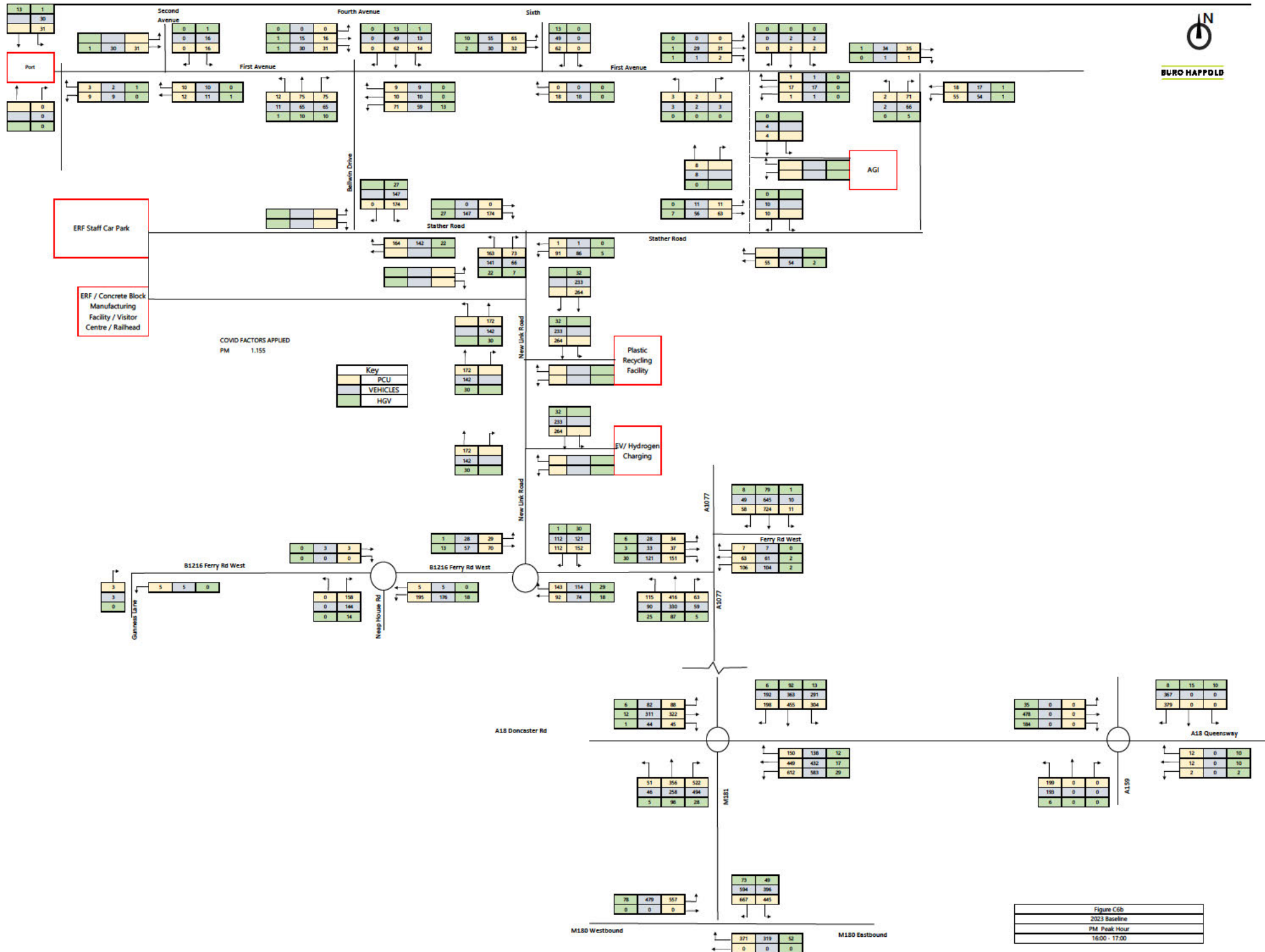

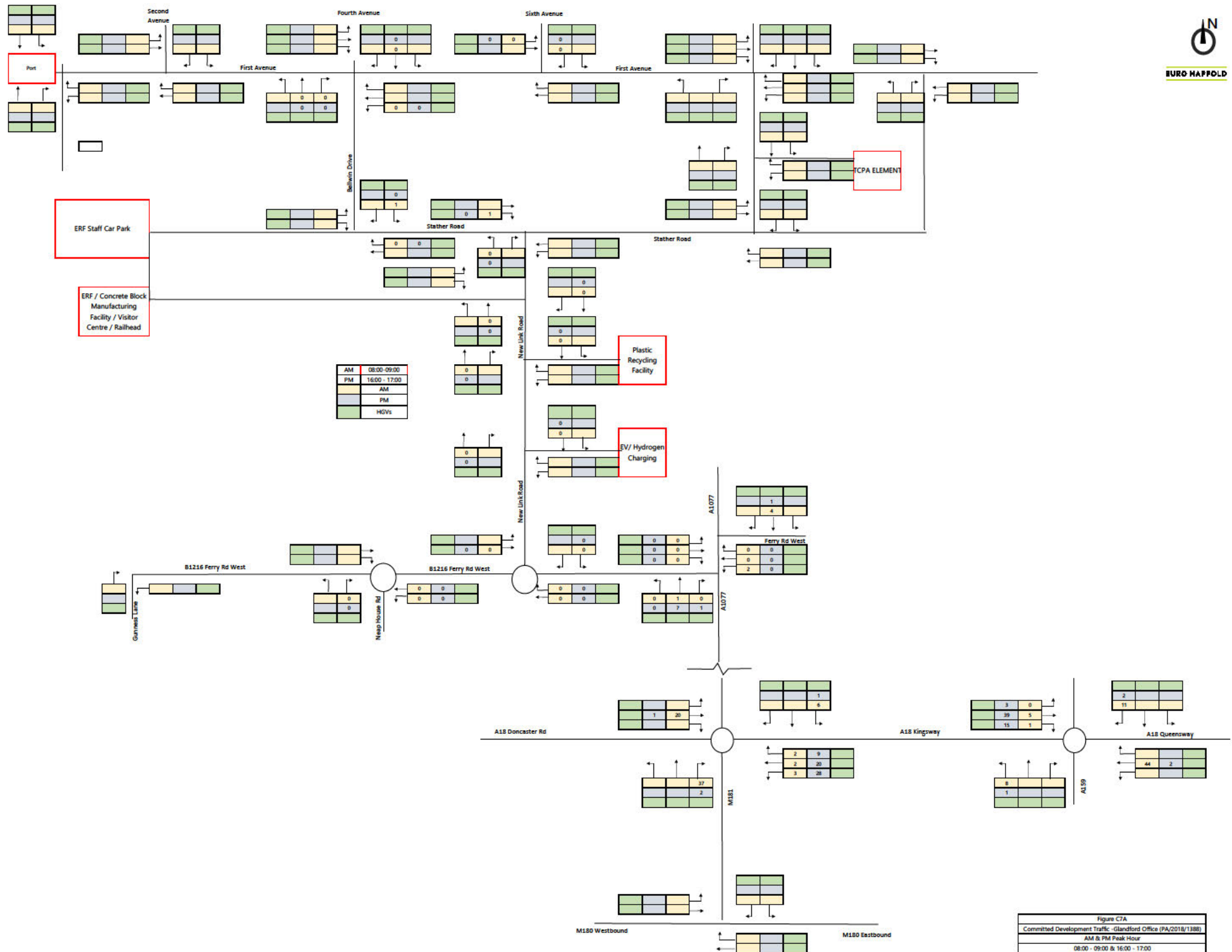

Figure C7A
 Committed Development Traffic - Glandford Office (PA/2018/1388)
 AM & PM Peak Hour
 08:00 - 09:00 & 16:00 - 17:00

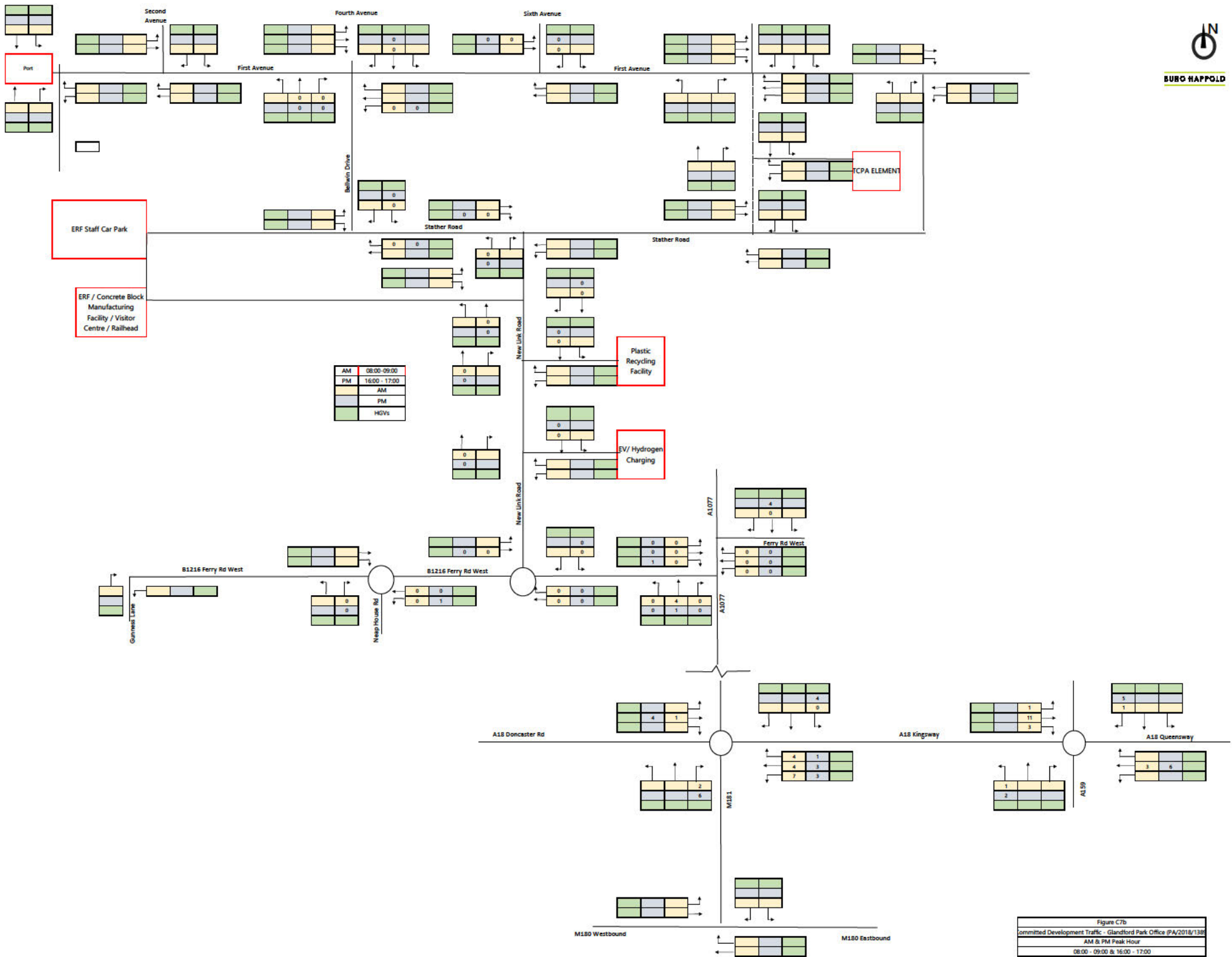

Figure C7b
 Committed Development Traffic - Glandford Park Office (PA/2018/138)
 AM & PM Peak Hour
 08:00 - 09:00 & 16:00 - 17:00

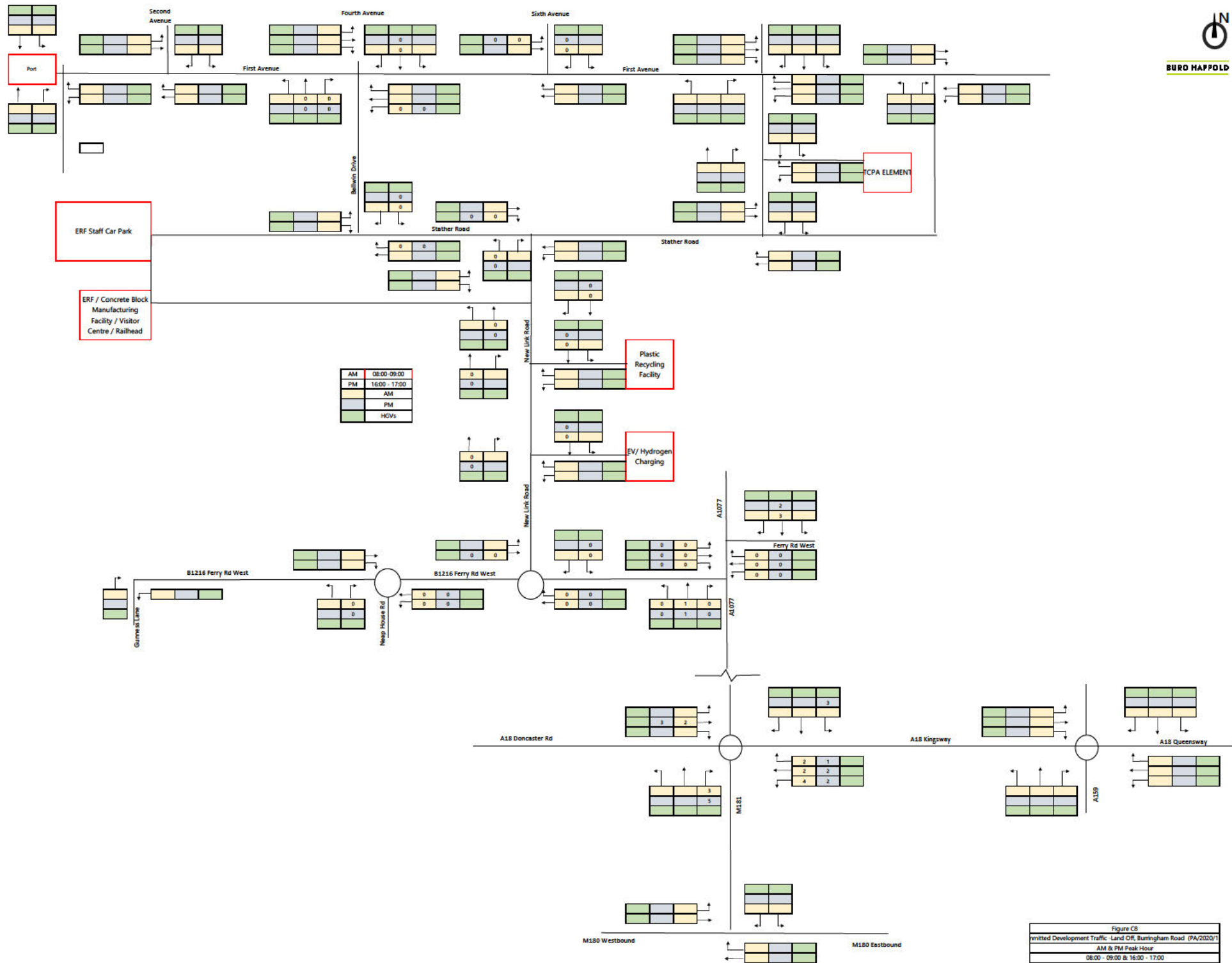

Figure C8
 emitted Development Traffic: Land Off, Birmingham Road (PA/2020/1)
 AM & PM Peak Hour
 08:00 - 09:00 & 16:00 - 17:00

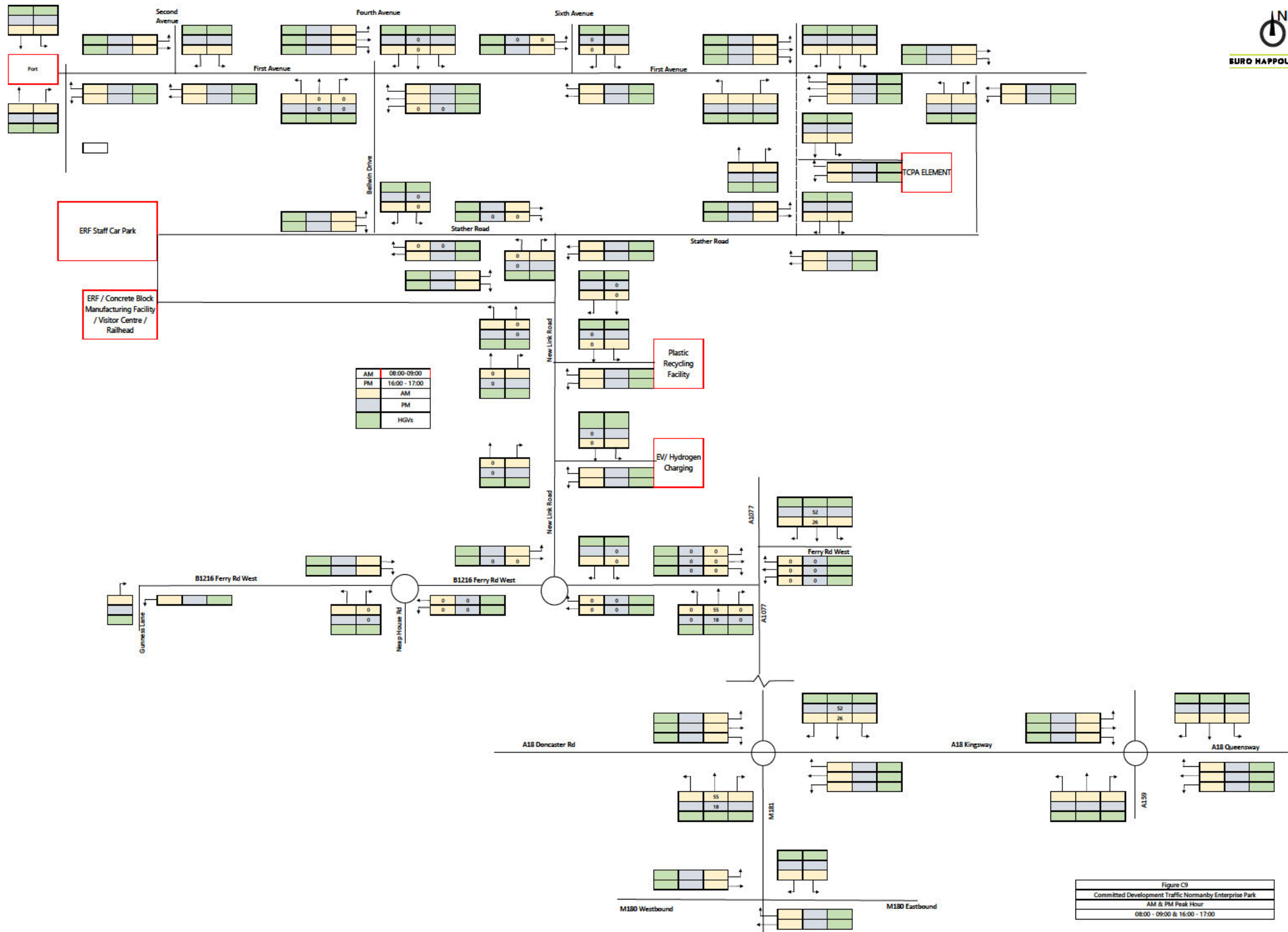

Figure C9
Committed Development Traffic Normanby Enterprise Park
AM & PM Peak Hour
08:00 - 09:00 & 16:00 - 17:00

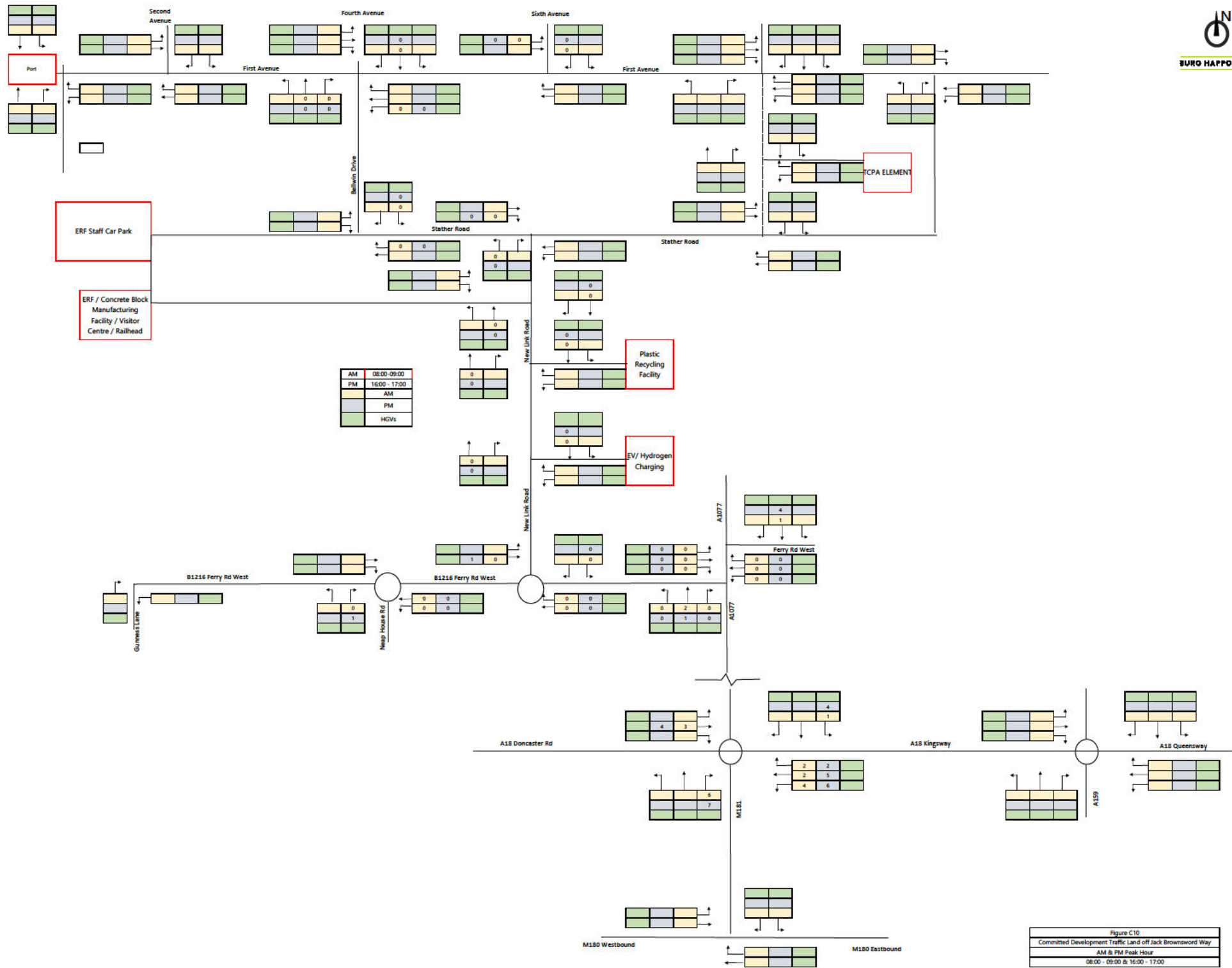

Figure C10
Committed Development Traffic Land off Jack Brownsword Way
AM & PM Peak Hour
08:00 - 09:00 & 16:00 - 17:00

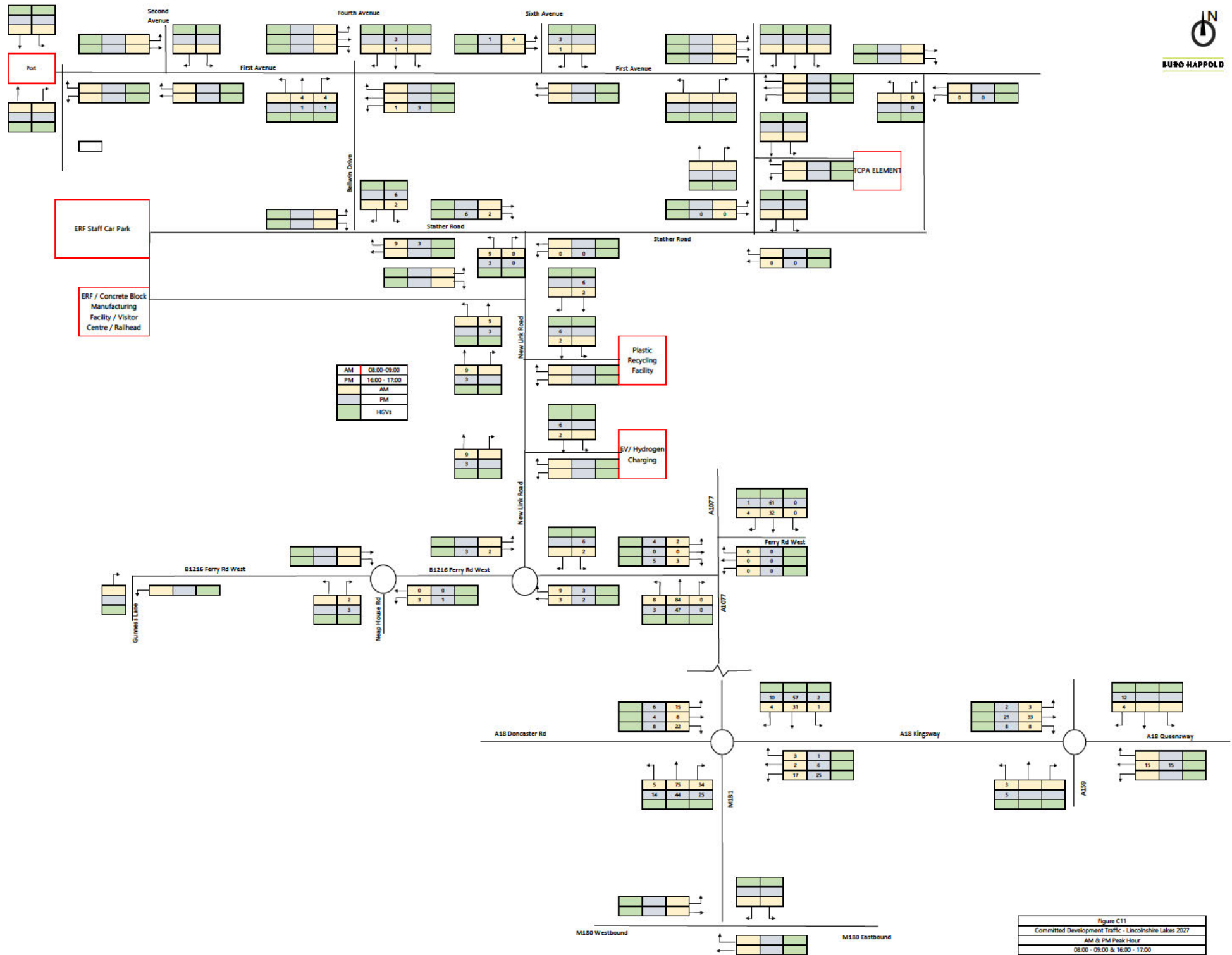

Figure C11
Committed Development Traffic - Lincolnshire Lakes 2027
AM & PM Peak Hour
08:00 - 09:00 & 16:00 - 17:00

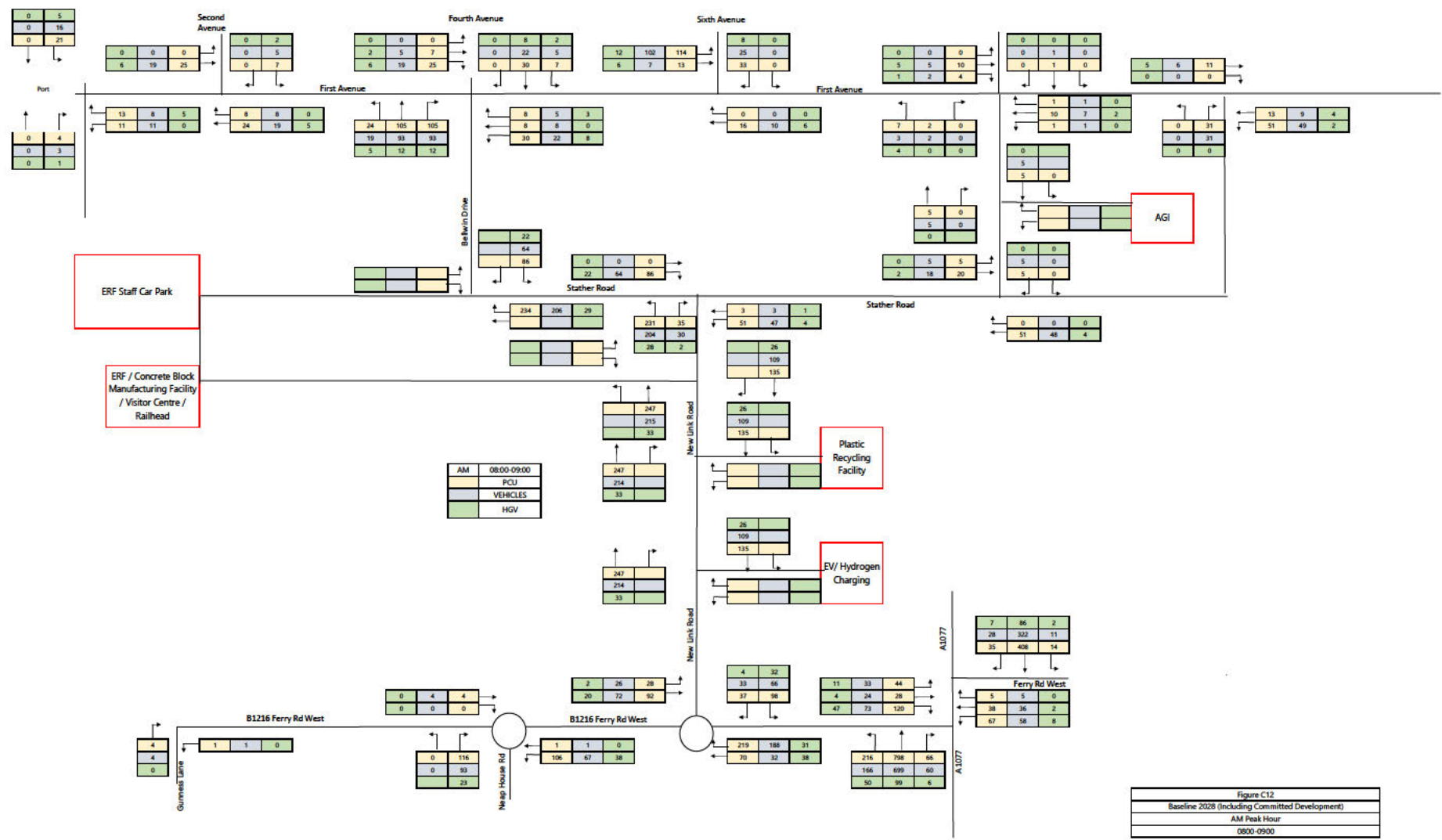
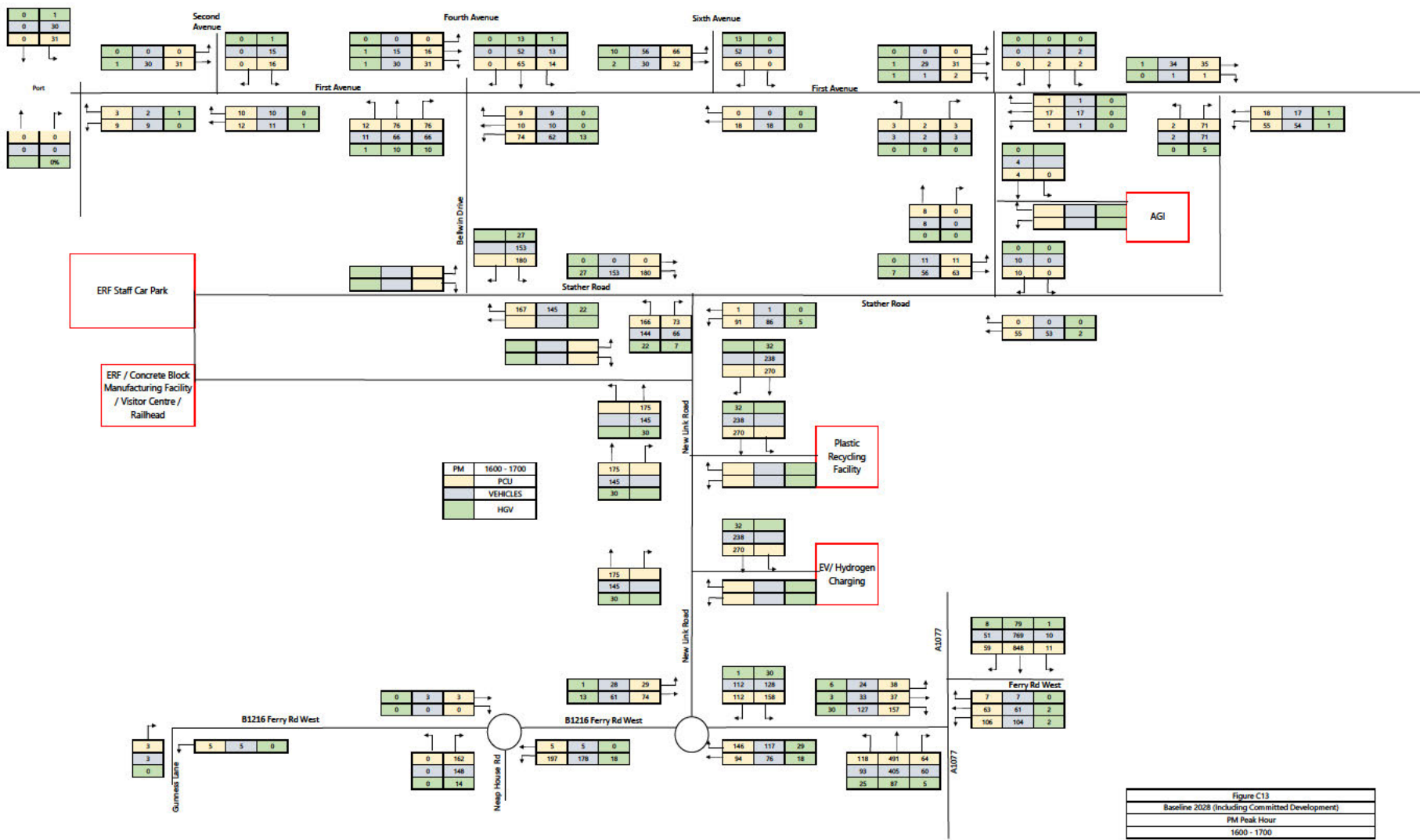
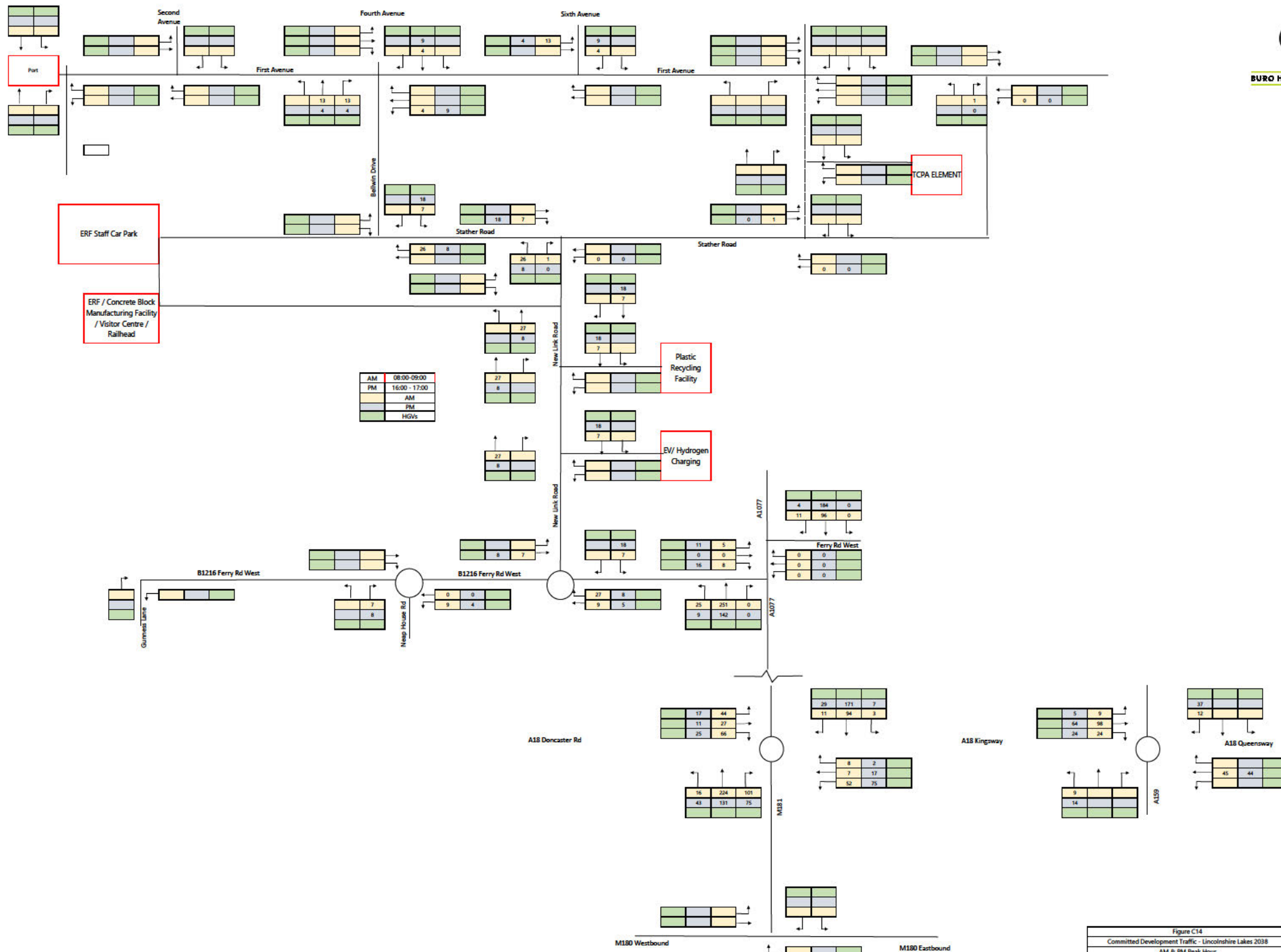

Figure C12
Baseline 2028 (Including Committed Development)
AM Peak Hour
0800-0900





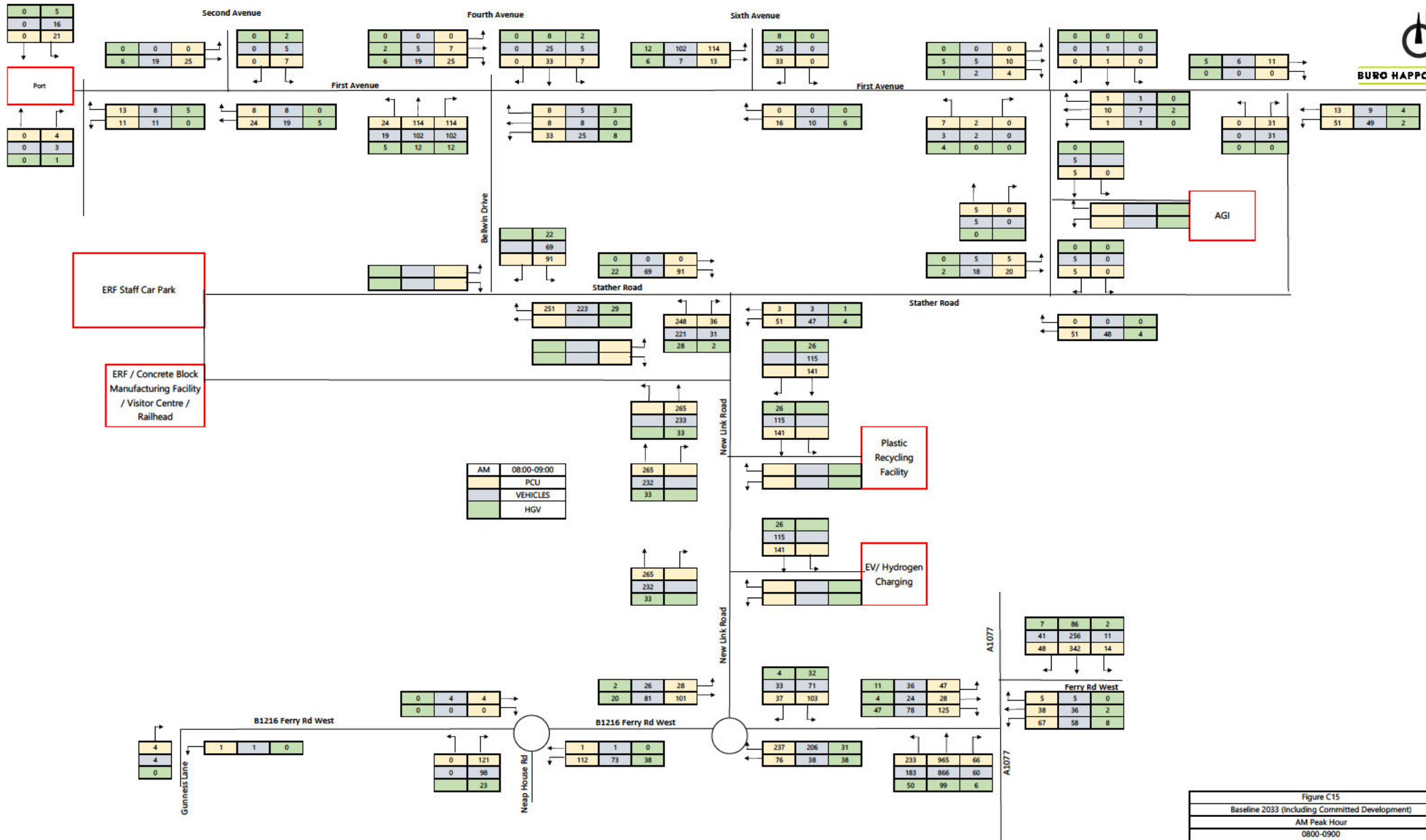

Figure C15
Baseline 2033 (Including Committed Development)
AM Peak Hour
0800-0900

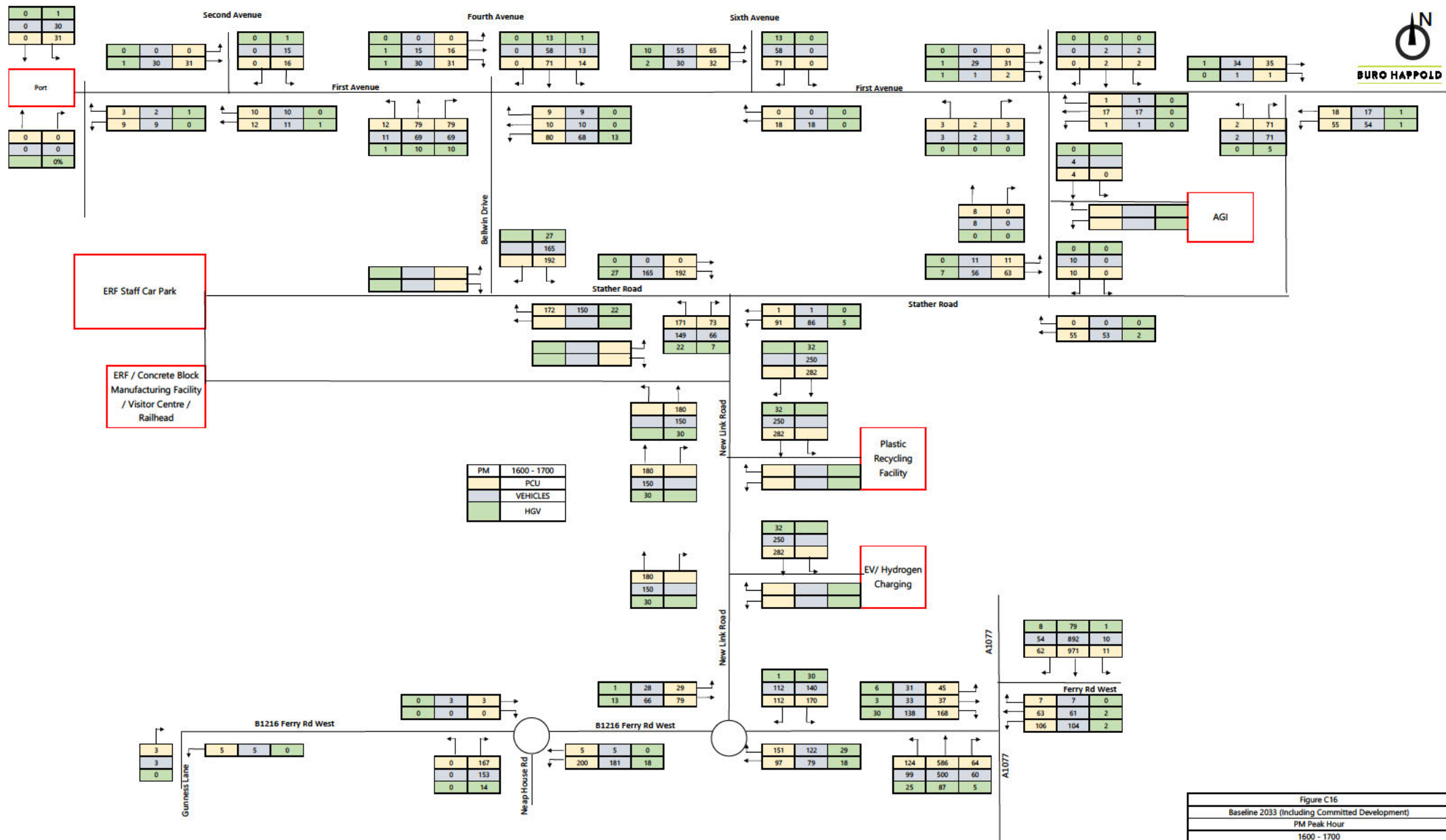

Figure C16
Baseline 2033 (Including Committed Development)
PM Peak Hour
1600 - 1700

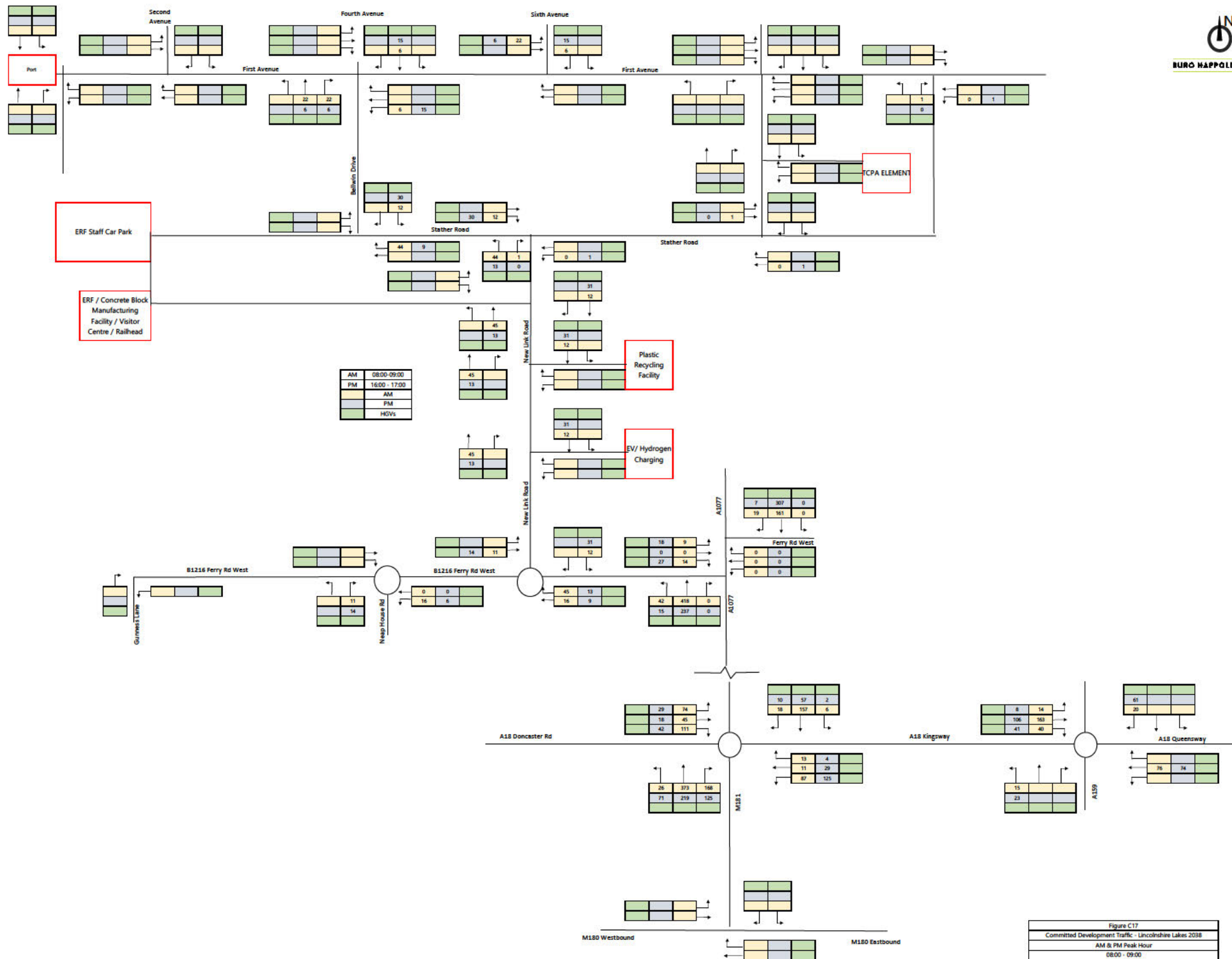

Figure C17
 Committed Development Traffic - Lincolnshire Lakes 2038
 AM & PM Peak Hour
 08:00 - 09:00

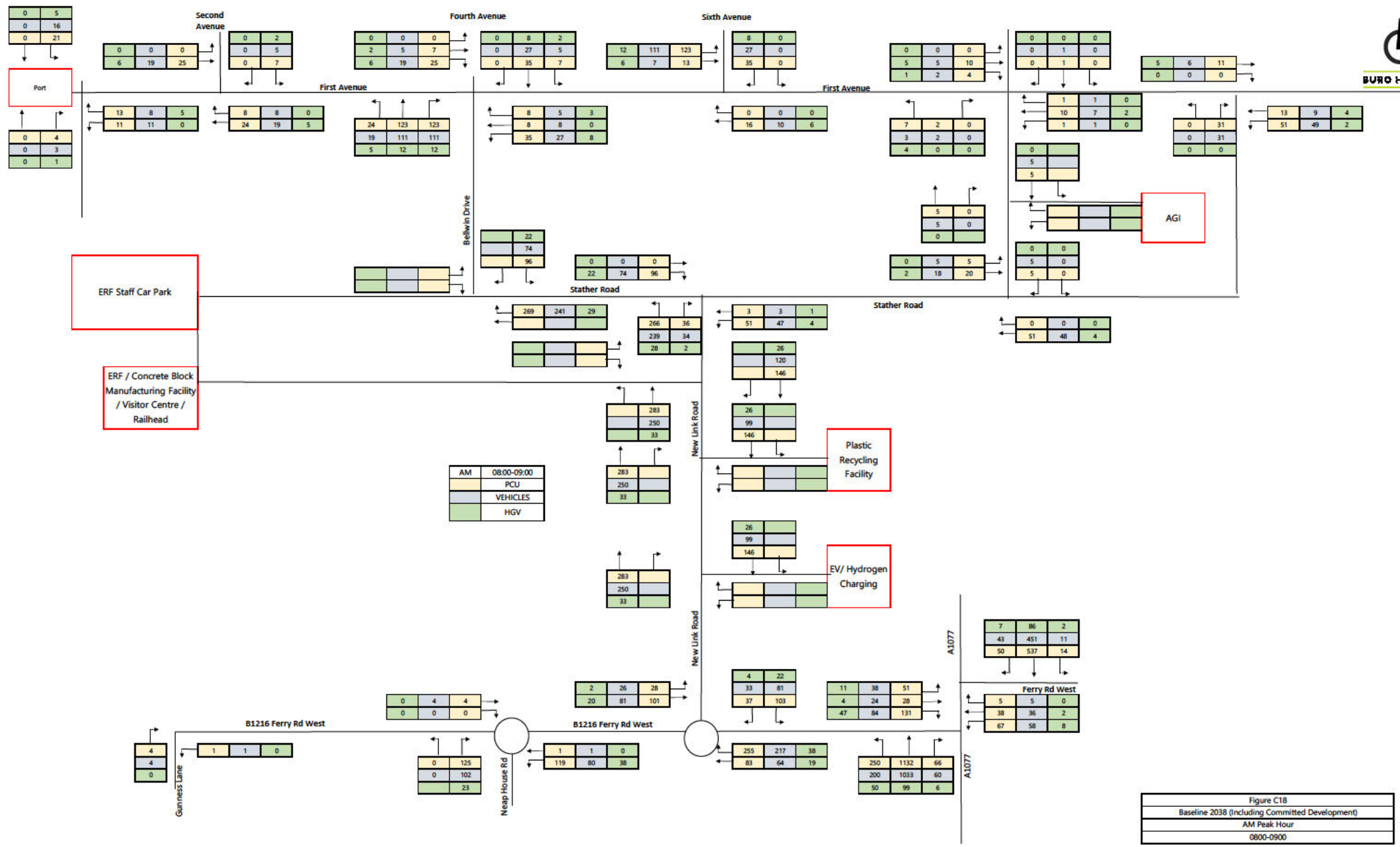

Figure C18
 Baseline 2038 (including Committed Development)
 AM Peak Hour
 0800-0900

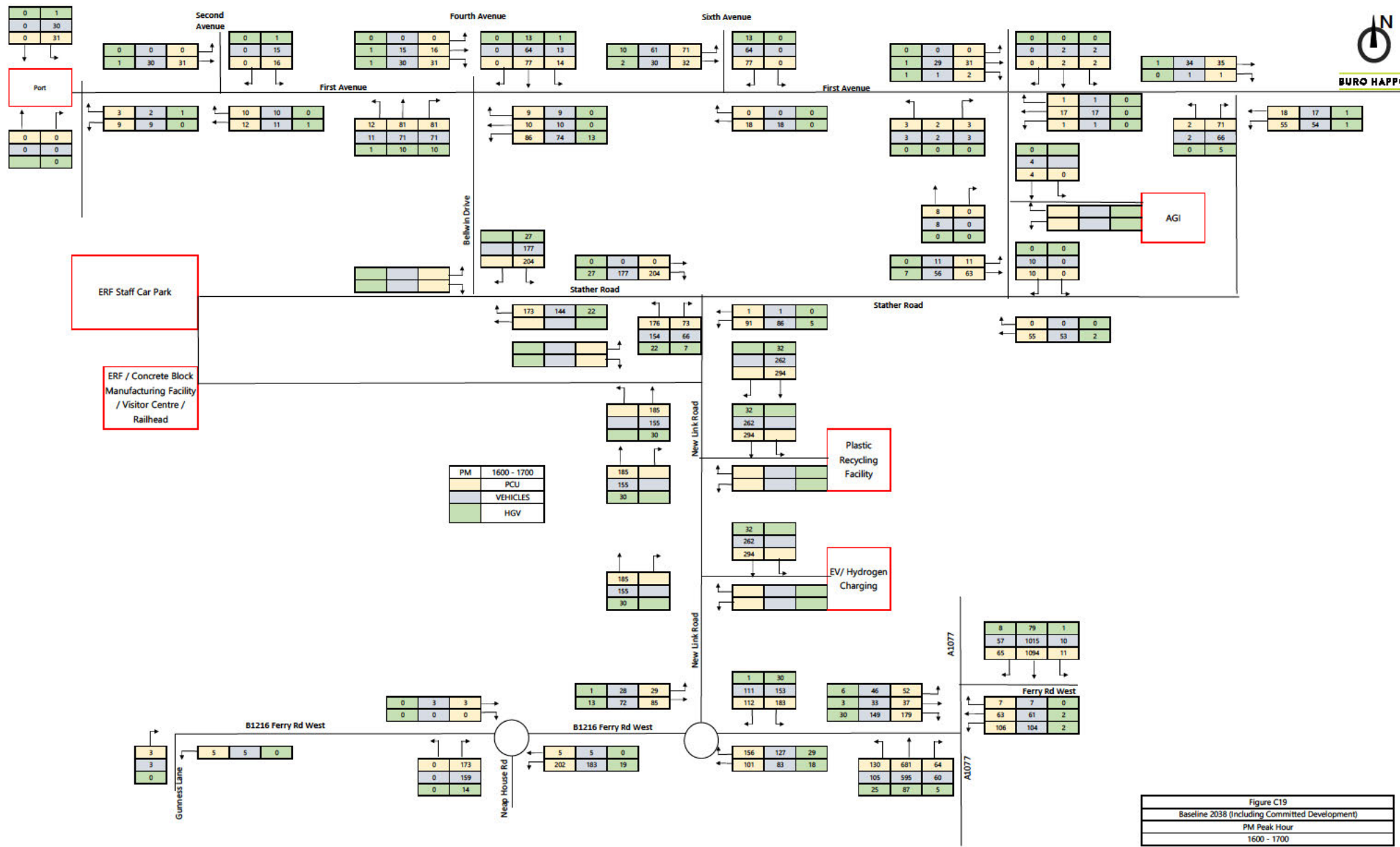

Figure C19
 Baseline 2038 (Including Committed Development)
 PM Peak Hour
 1600 - 1700

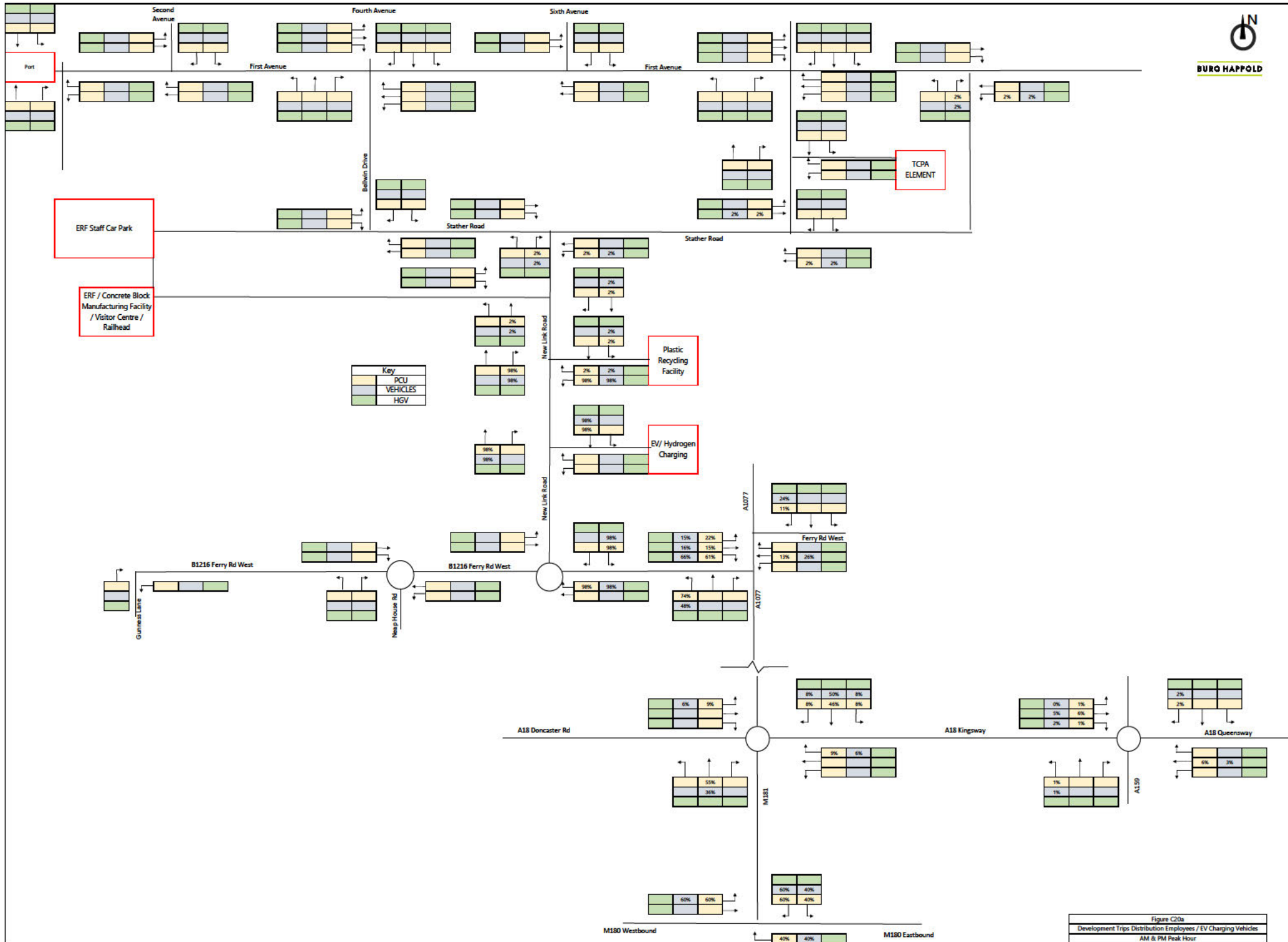
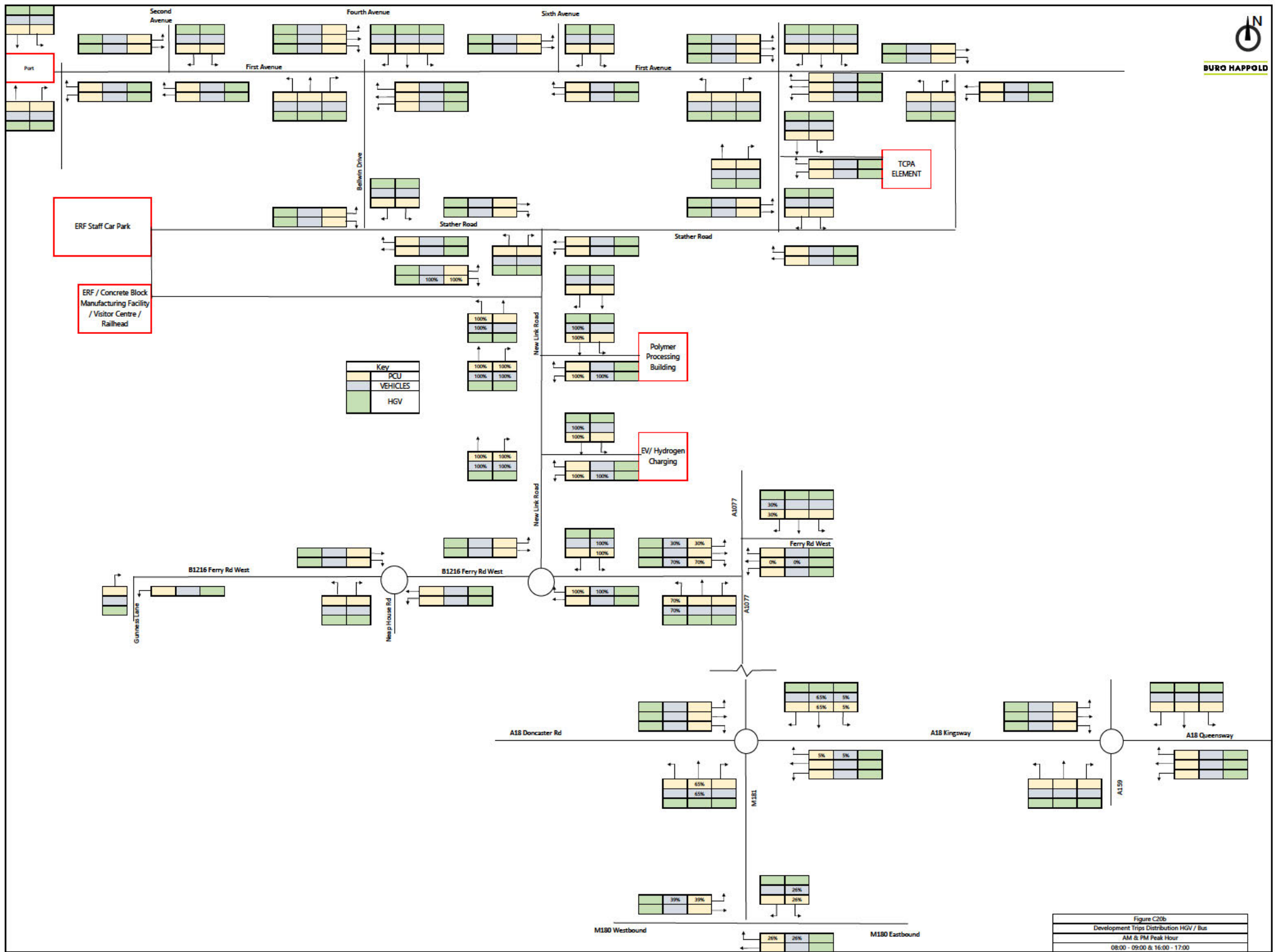
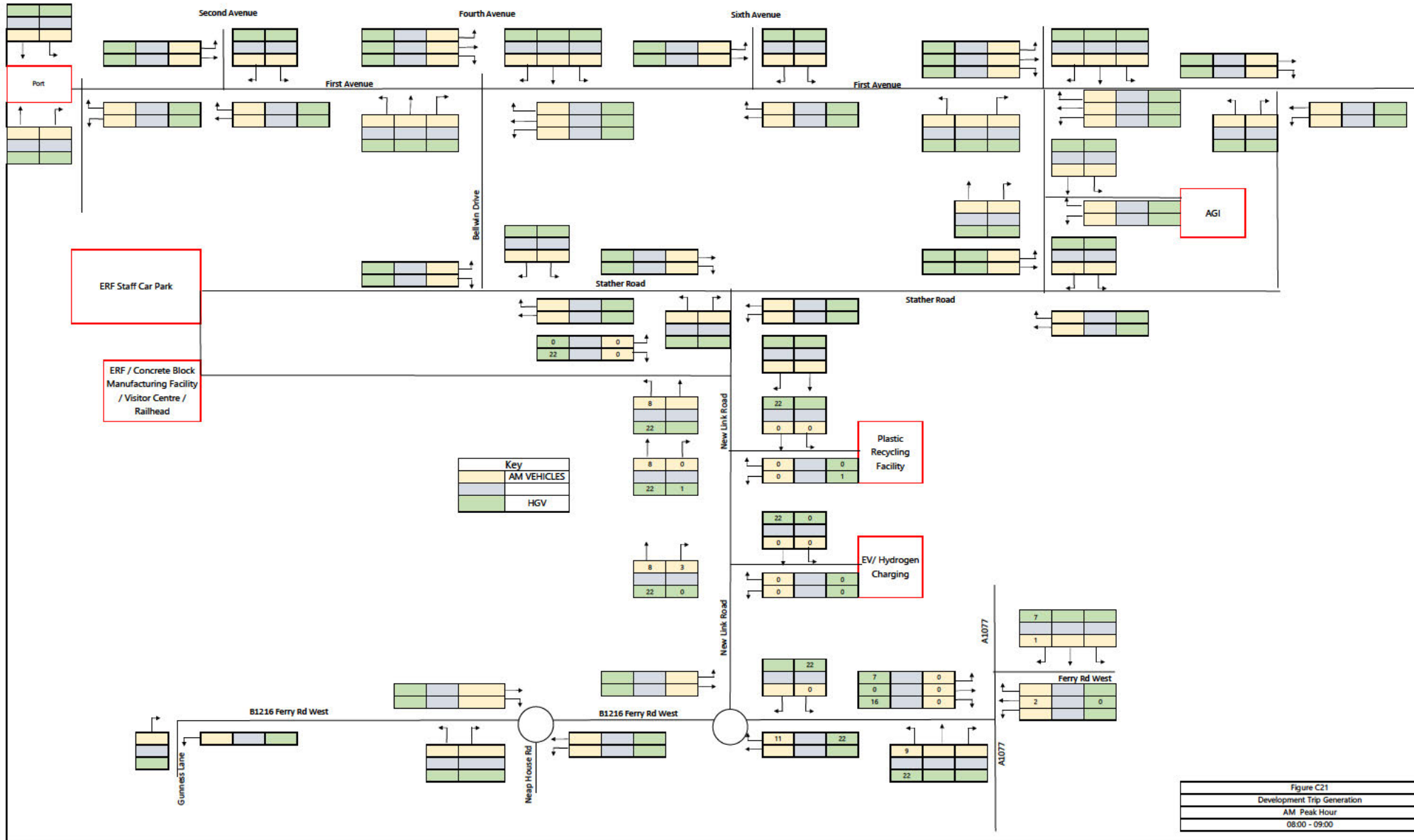

Figure C20a
 Development Trips Distribution Employees / EV Charging Vehicles
 AM & PM Peak Hour



Key	
[Yellow Box]	PCU
[Grey Box]	VEHICLES
[Green Box]	HGV

Figure C20b
Development Trips Distribution HGV / Bus
AM & PM Peak Hour
08:00 - 09:00 & 16:00 - 17:00



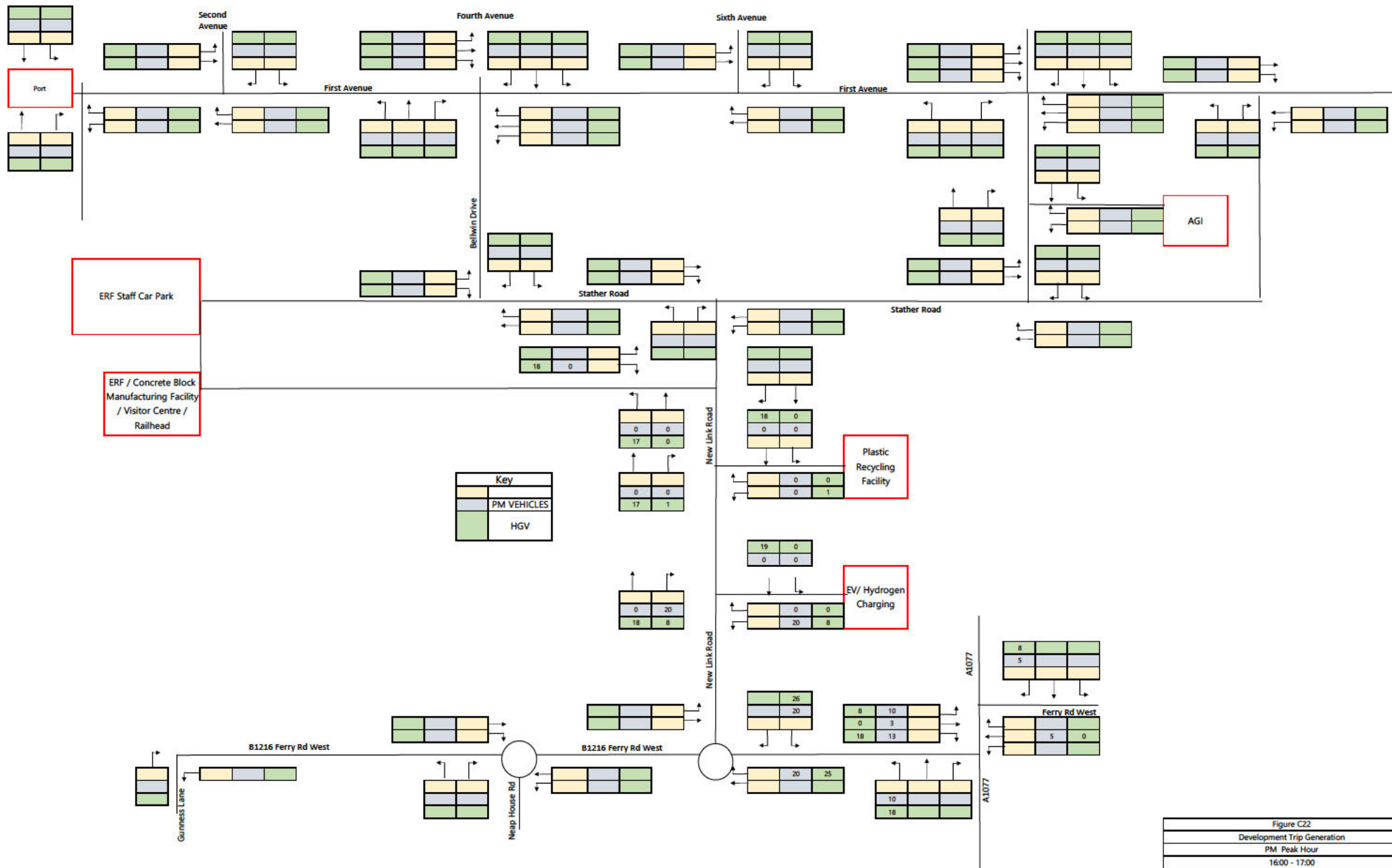



BURO HAPFOLD

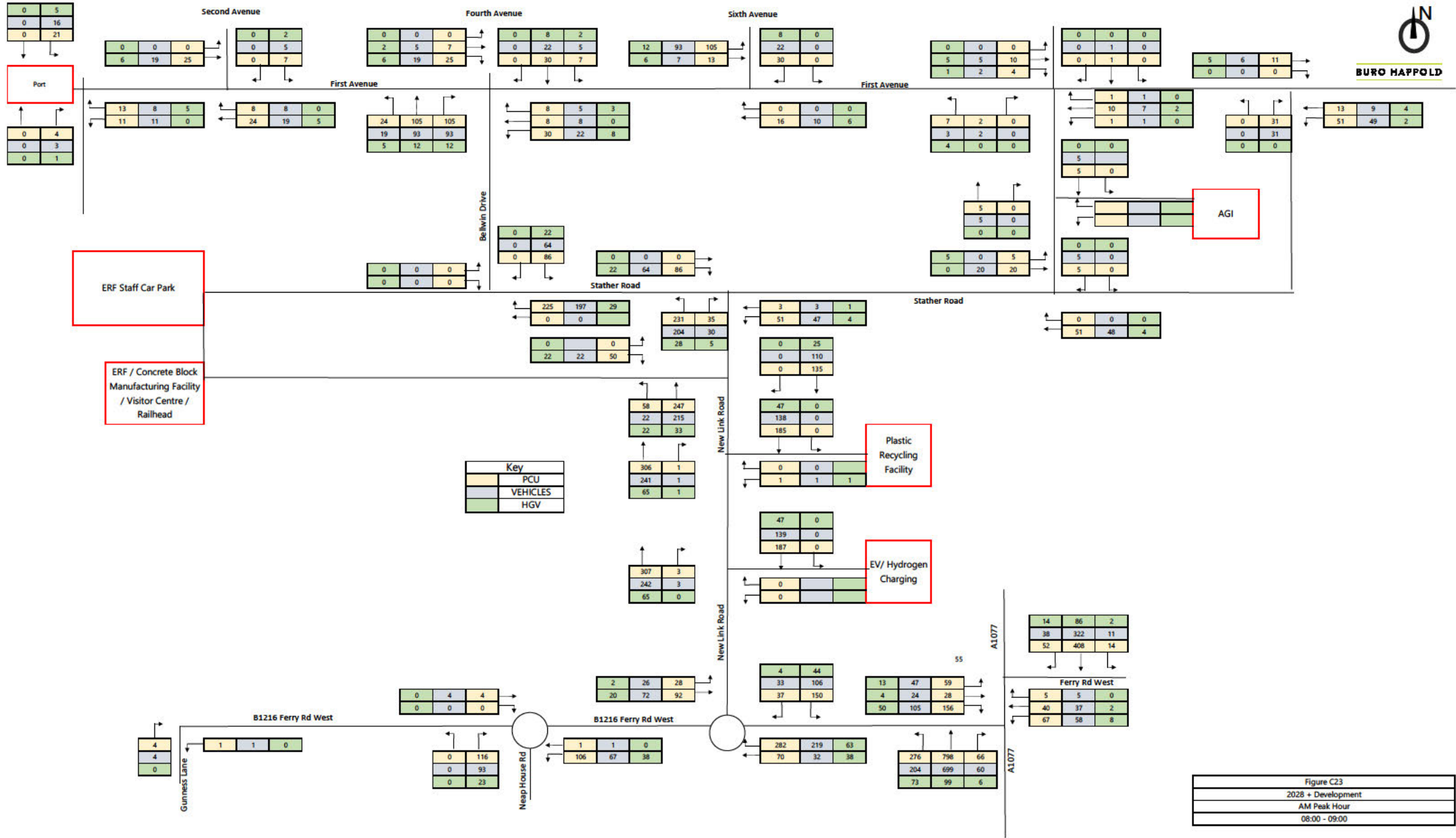

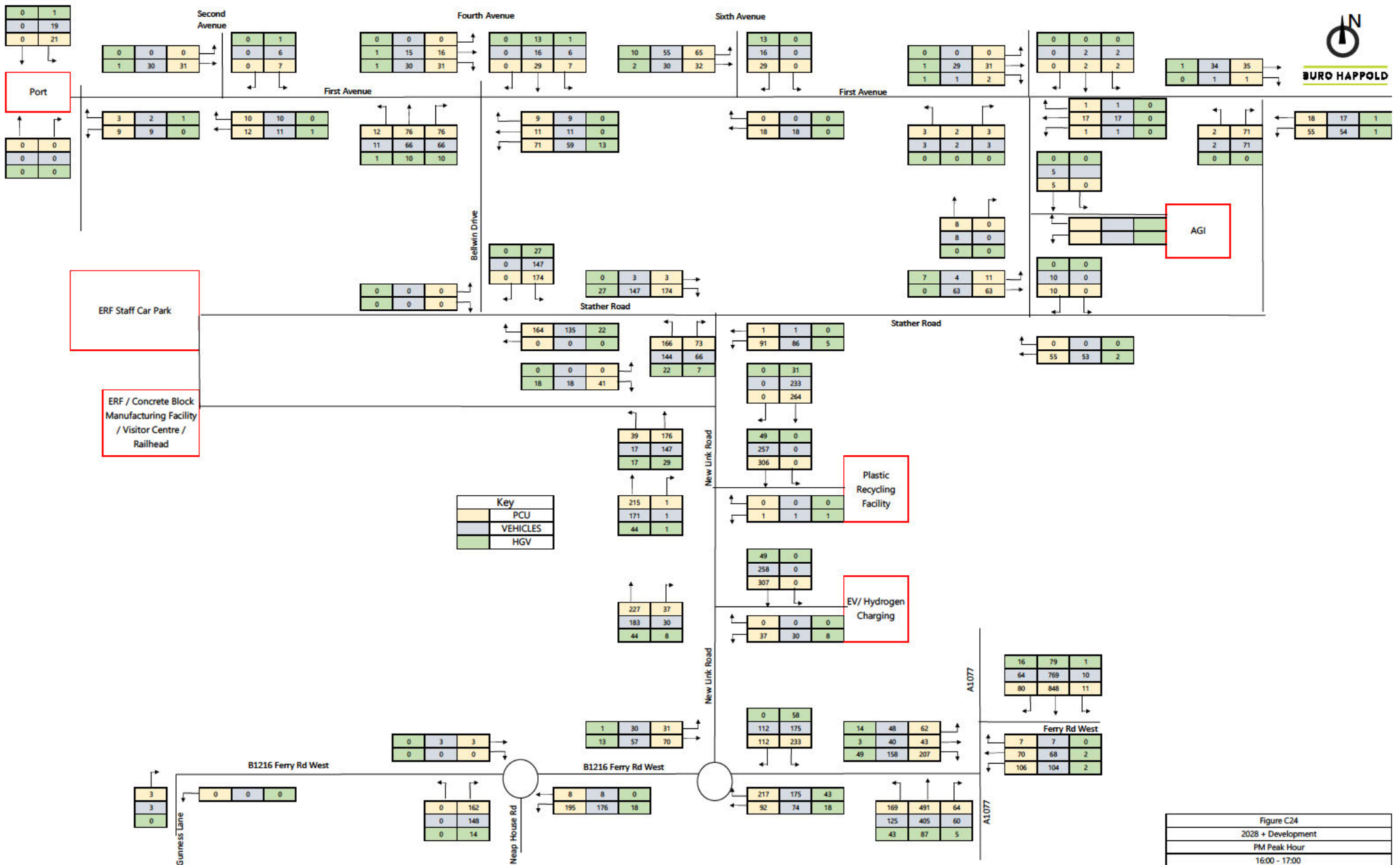
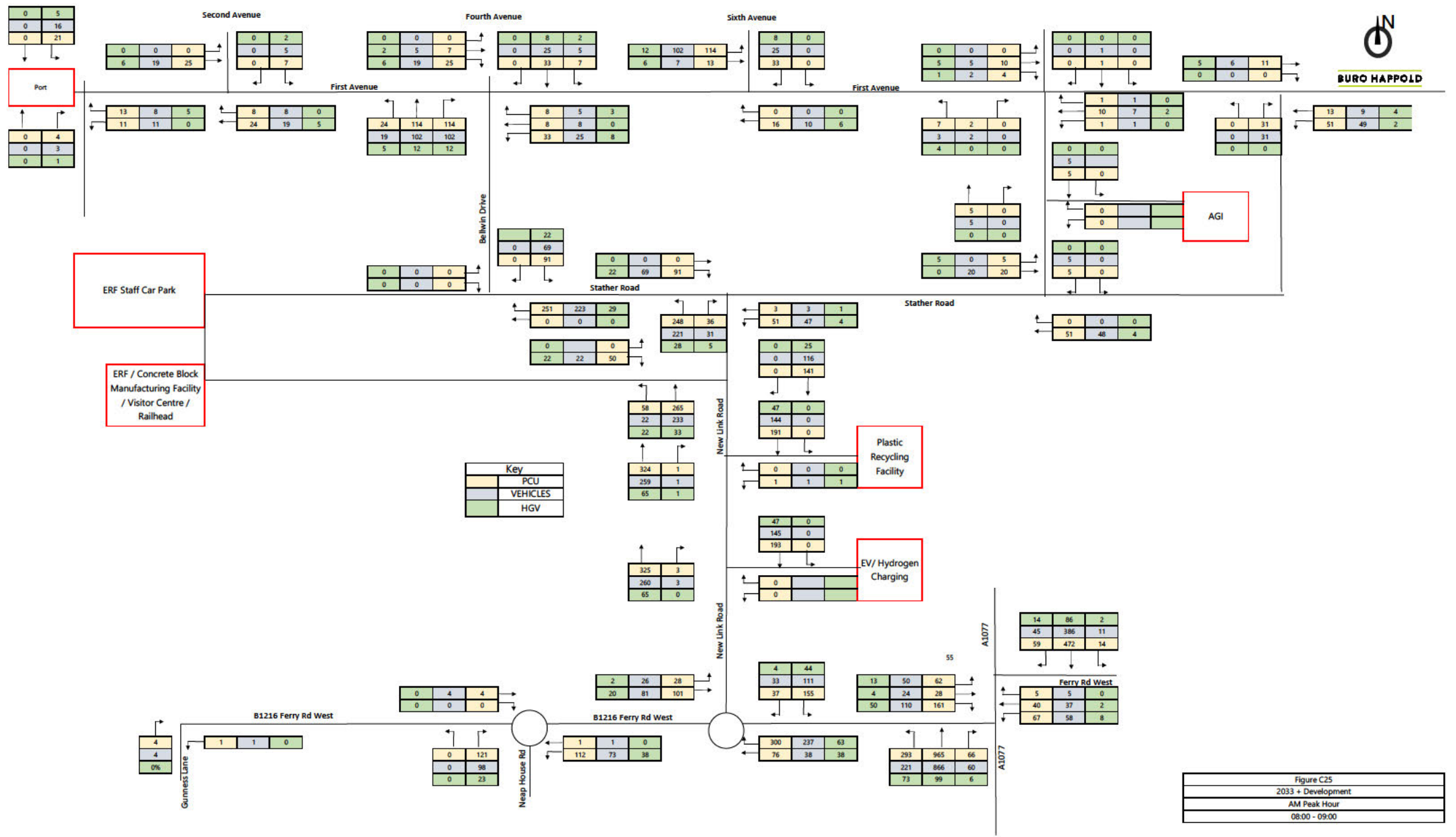
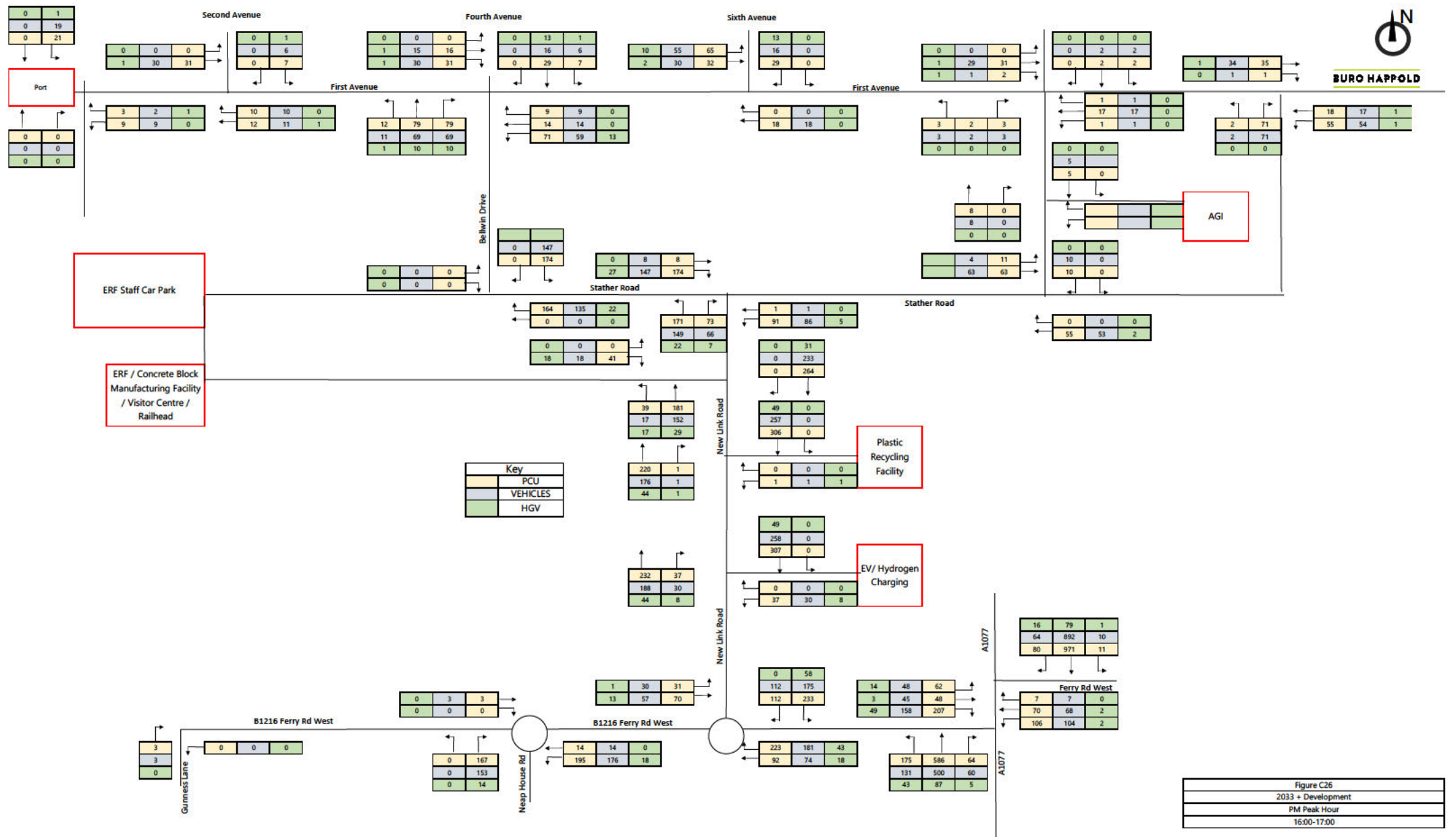
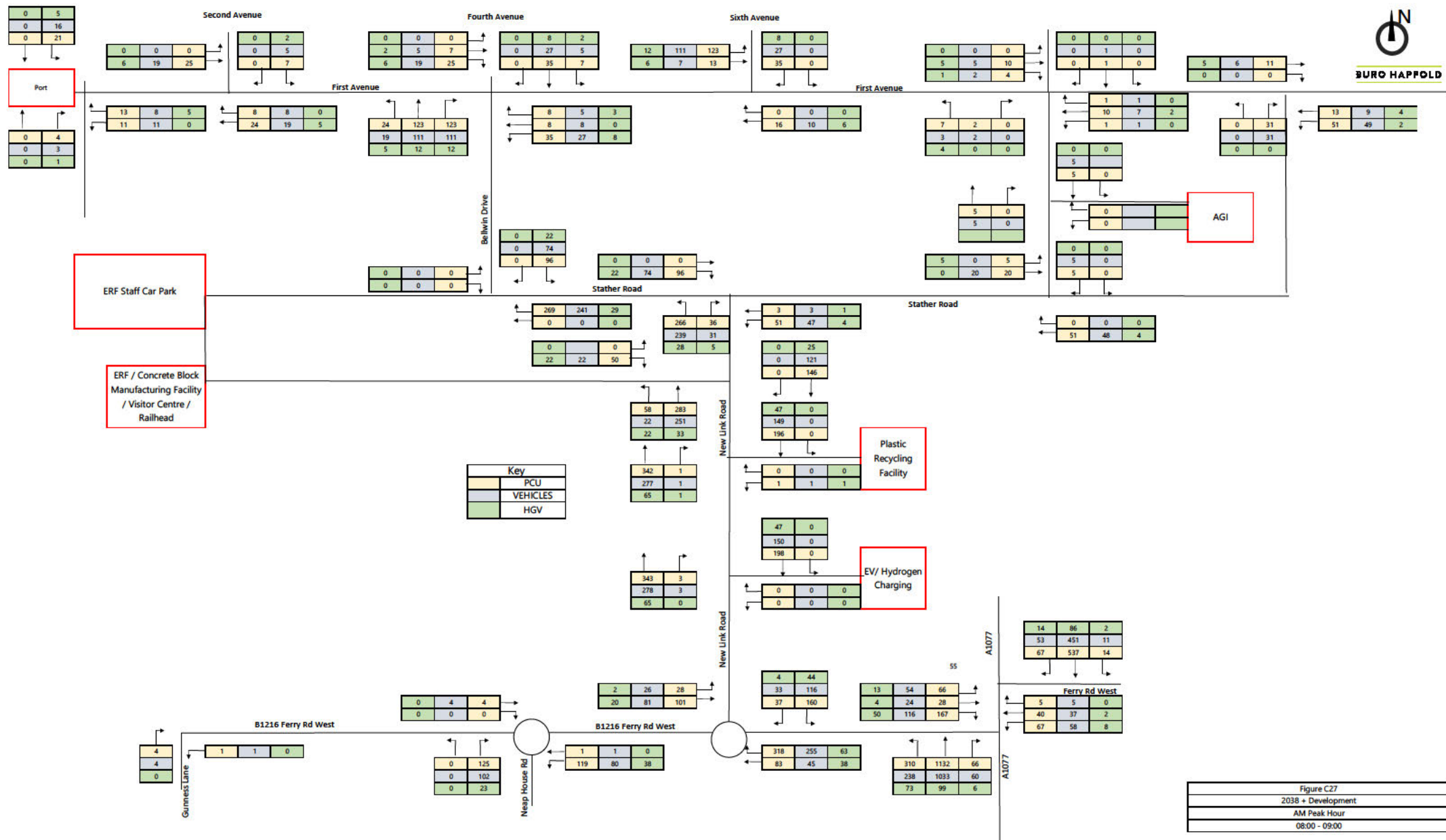

Figure C24
2028 + Development
PM Peak Hour
16:00 - 17:00







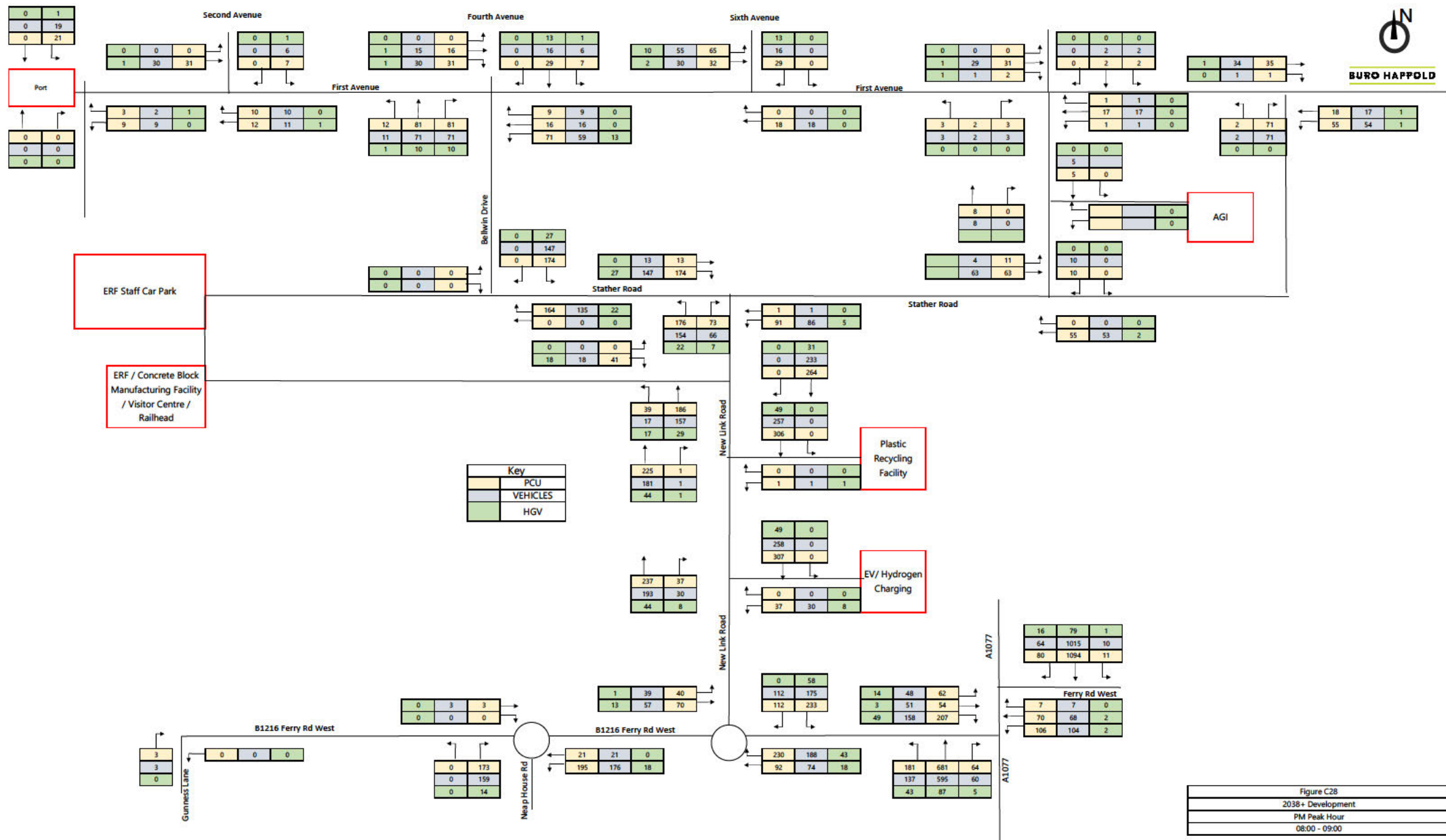
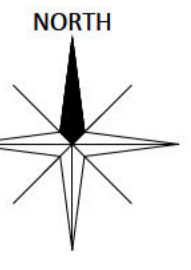
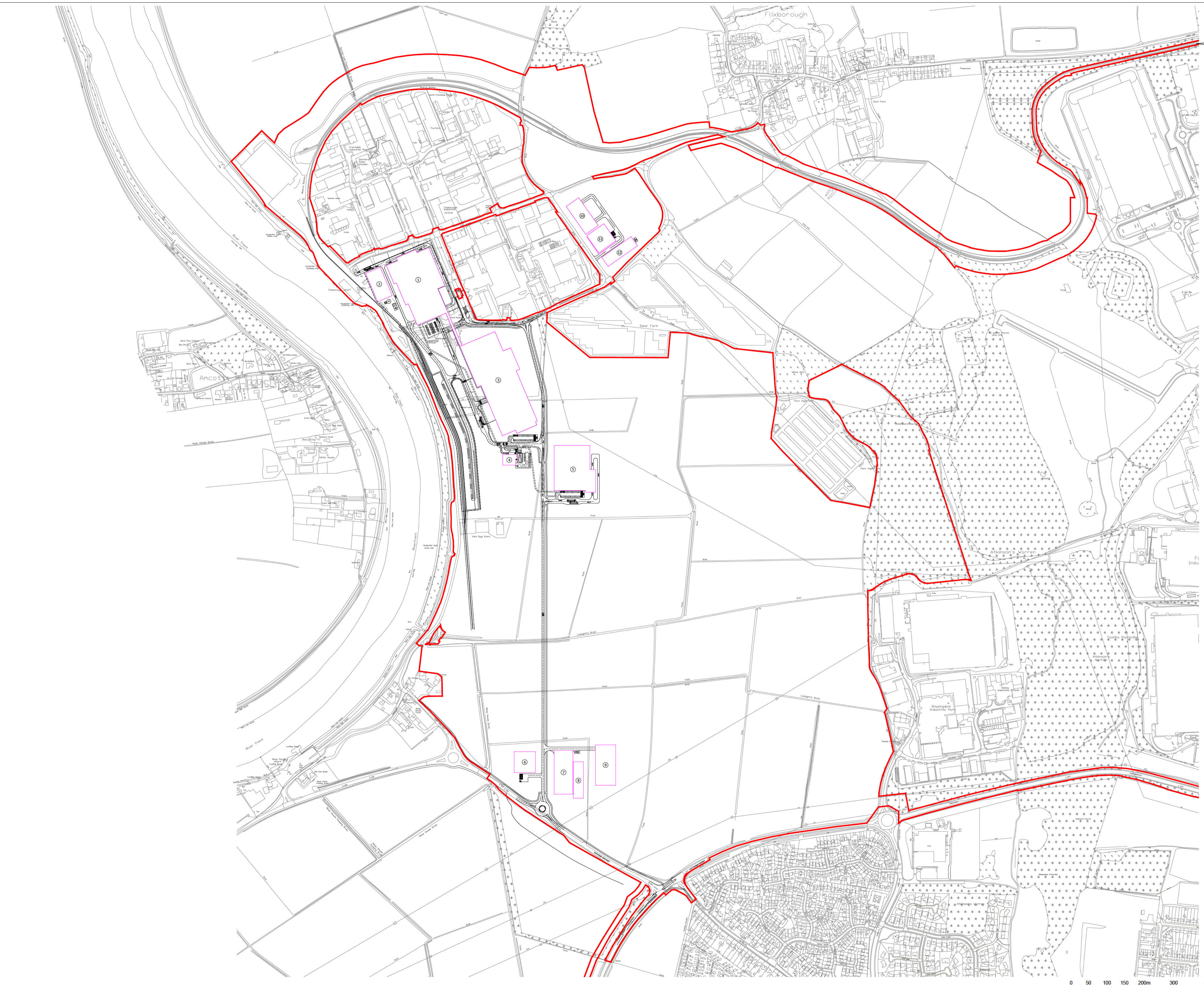

Figure C28
2038 + Development
PM Peak Hour
08:00 - 09:00

Appendix D Proposed Layout Plan at the Project



Planning Act 2008
The Infrastructure Planning
(Applications: Prescribed forms and Procedure) Regulations 2009
Regulation: 5(2)(c)

NOTES
OS Licensing information for OS CAD/GIS & raster data orders -
© crown copyright and database rights 2021 OS Licence 100035409

- LEGEND**
- ORDER LIMITS
 - ① ERF
 - ② CARBON CAPTURE
 - ③ ASH, FGTV REPROCESSING AND CONCRETE BLOCK MANUFACTURING
 - ④ VISITORS CENTRE
 - ⑤ PLASTICS RECYCLING FACILITY
 - ⑥ AGI
 - ⑦ VEHICLE REFUELLING STATION
 - ⑧ HYDROGEN PRODUCTION
 - ⑨ BATTERY STORAGE
 - ⑩ ERF SUBSTATIONS
 - ⑪ AGI
 - ⑫ HYDROGEN PRODUCTION

PD	FOR DCO SUBMISSION	17.02.22	AO1	DTW/CAB
Rev	Description	Date	Iss'd	Rev'd

DCO SUBMISSION

INFORMATION

Client

Level 33, Euston Tower, 296 Euston Road, London, NW1 3DF

LD A DESIGN GSDA FICHTNER ERM BORO HAPPOLD northern planners bowland ecology

Client: NORTH LINCOLNSHIRE GREEN ENERGY PARK LTD
 Consultant: FICHTNER CONSULTING ENGINEERS
 Project: NORTH LINCOLNSHIRE GREEN ENERGY PARK
 Dwg Title: INDICATIVE SITE LAYOUT

Planning Inspectorate No. EN010116	Scale@A1 1:5000	
Drawn/Designed By: AO1	Checked By: DTW	Approved By: CAB
Drawing No. NLGEP-FCE-XX-XX-DR-Y-5001	Revision PO	

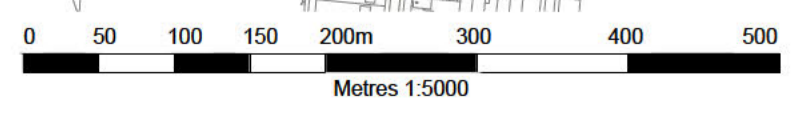

Appendix E Highway Stopping Up Plan for Stather Road

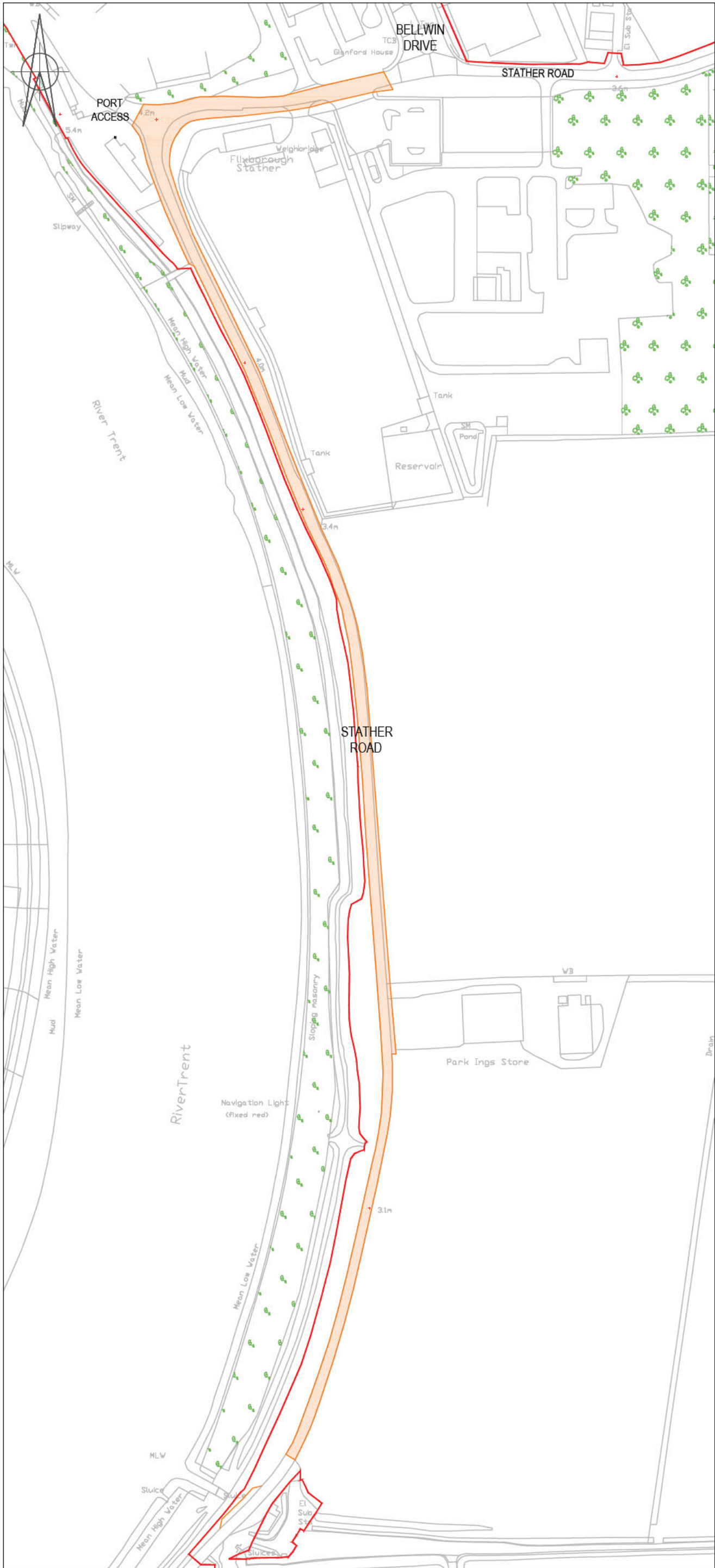

KEY

- AREA OF PUBLIC HIGHWAY TO BE STOPPED UP
- DCO LIMITS

DRAWING NOT TO SCALE

Copyright © 1976-2020 Buro Happold. All Rights Reserved

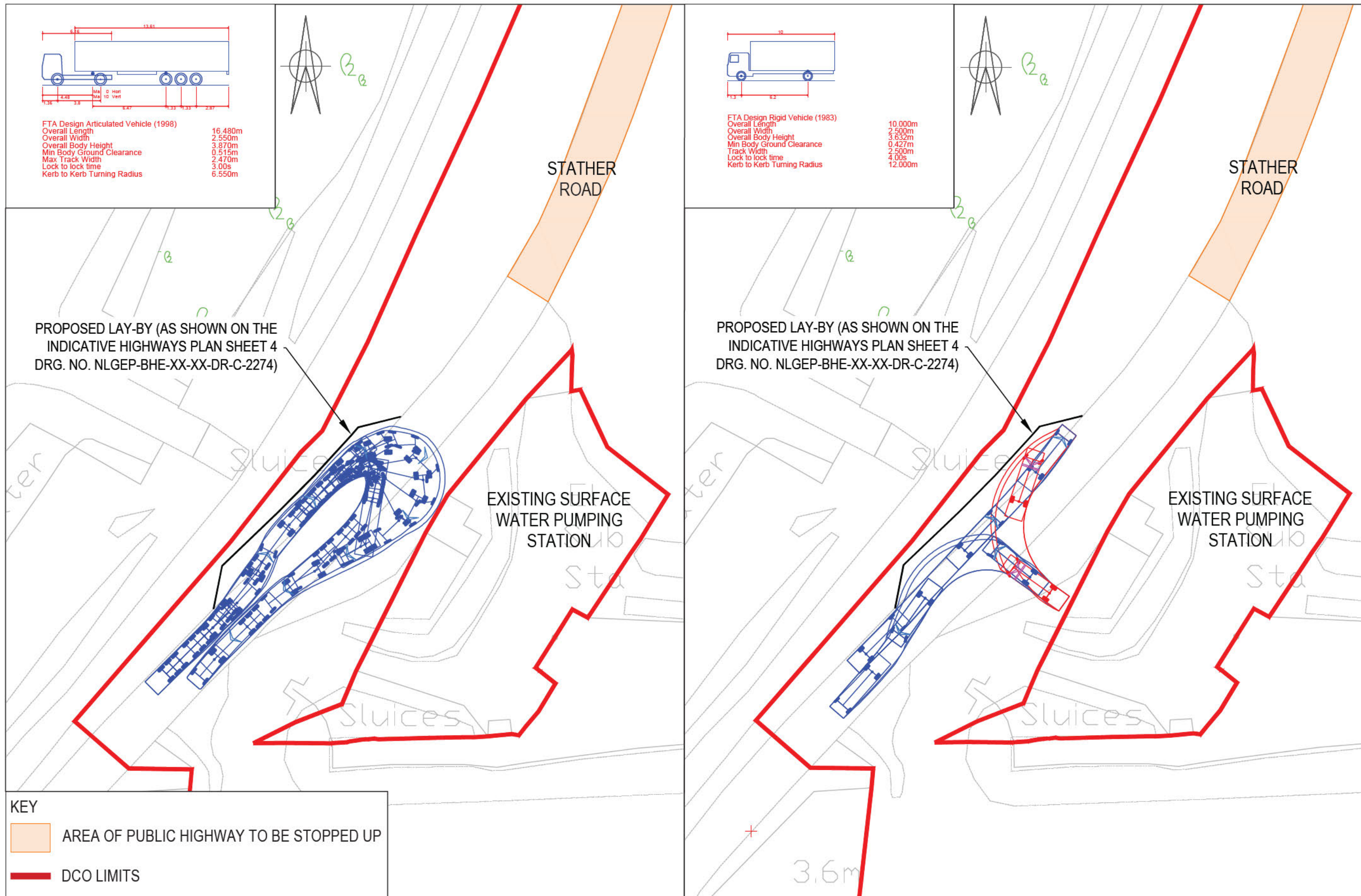

	Project: North Lincolnshire Green Energy Park (NLGEP)	Project Number: 0046658	Status: PRELIMINARY		
	Sketch Title: Proposed Lay-by at Existing Pumping Station Swept Paths Analysis: 16.5m Articulated Vehicle and 10m Rigid Vehicle	Sketch Number: SK06	Date: 18/01/22	Initials: JW	Revision: 001

Appendix F Proposed Highway Improvements

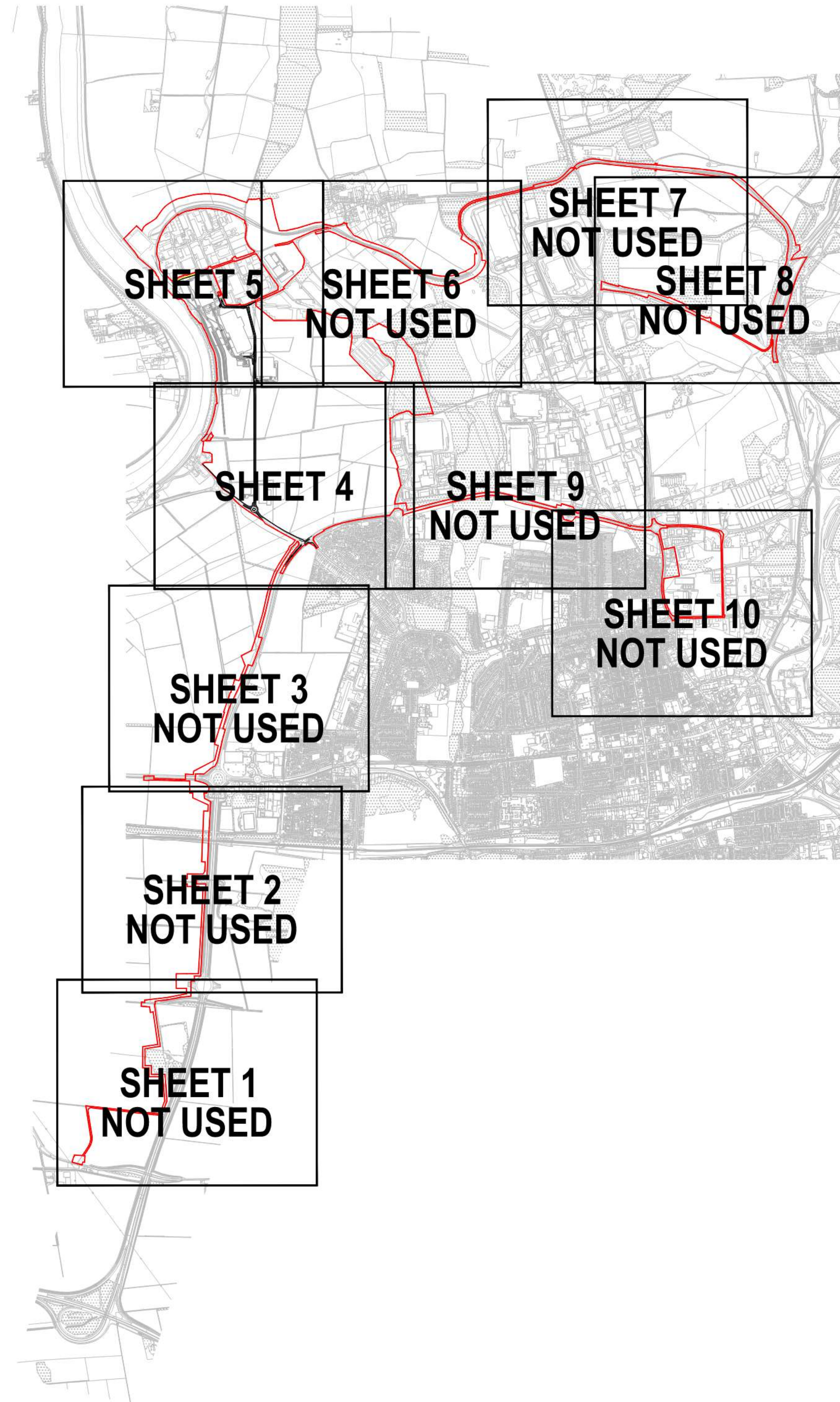
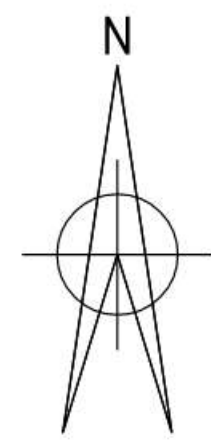

NOTES:

1. THIS DRAWING SHOULD BE READ IN CONJUNCTION WITH ALL OTHER RELEVANT DRAWINGS AND SPECIFICATIONS.
2. DRAWINGS BASED ON THE FOLLOWING BACKGROUND INFORMATION:
 - ORDNANCE SURVEY MAPS RECEIVED © CROWN COPYRIGHT AND DATABASE RIGHTS 2021 OS LICENCE 100035409
3. THE COMPLETENESS OF THE UNDERGROUND SERVICE INFORMATION CANNOT BE GUARANTEED AND THEREFORE OTHER SERVICES MAY EXIST.

LEGEND

PROPOSED	
	SITE BOUNDARY
	PROPOSED HIGHWAY LAYOUT
	PROPOSED WAITING TIME RESTRICTION
2.80	PROPOSED INDICATIVE LEVELS (mAOD) THAT CAN DEVIATE UP TO 1m HIGHER OR LOWER (BUT NO LESS THAN THE MINIMUM FRA RECOMMENDED LEVELS)

P0	ISSUED FOR DCO SUBMISSION	09.05.2022	FR	CB	CB
Rev	Description	Date	Iss'd	Rev'd	App'd

DCO SUBMISSION

Project Stage

INFORMATION

Status of Drawing

Client



Level 33, Euston Tower, 296 Euston Rd., London, NW1 3DP



Client: NORTH LINCOLNSHIRE GREEN ENERGY PARK LTD

Consultant: BURO HAPPOLD

Project: NORTH LINCOLNSHIRE GREEN ENERGY PARK

Dwg Title: INDICATIVE HIGHWAYS PLAN OVERALL SHEET

Planning Inspectorate No. EN010116 Scale@A1 1:20000

Drawn/Designed By: J.SLEEMAN Checked By: C.BYRNE Approved By: C.BYRNE

Drawing No. NLGEP-BHE-XX-XX-DR-C-2270 Revision P0

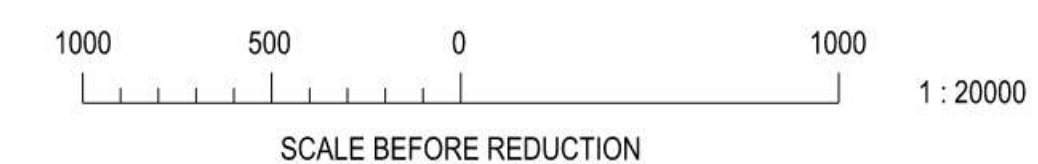

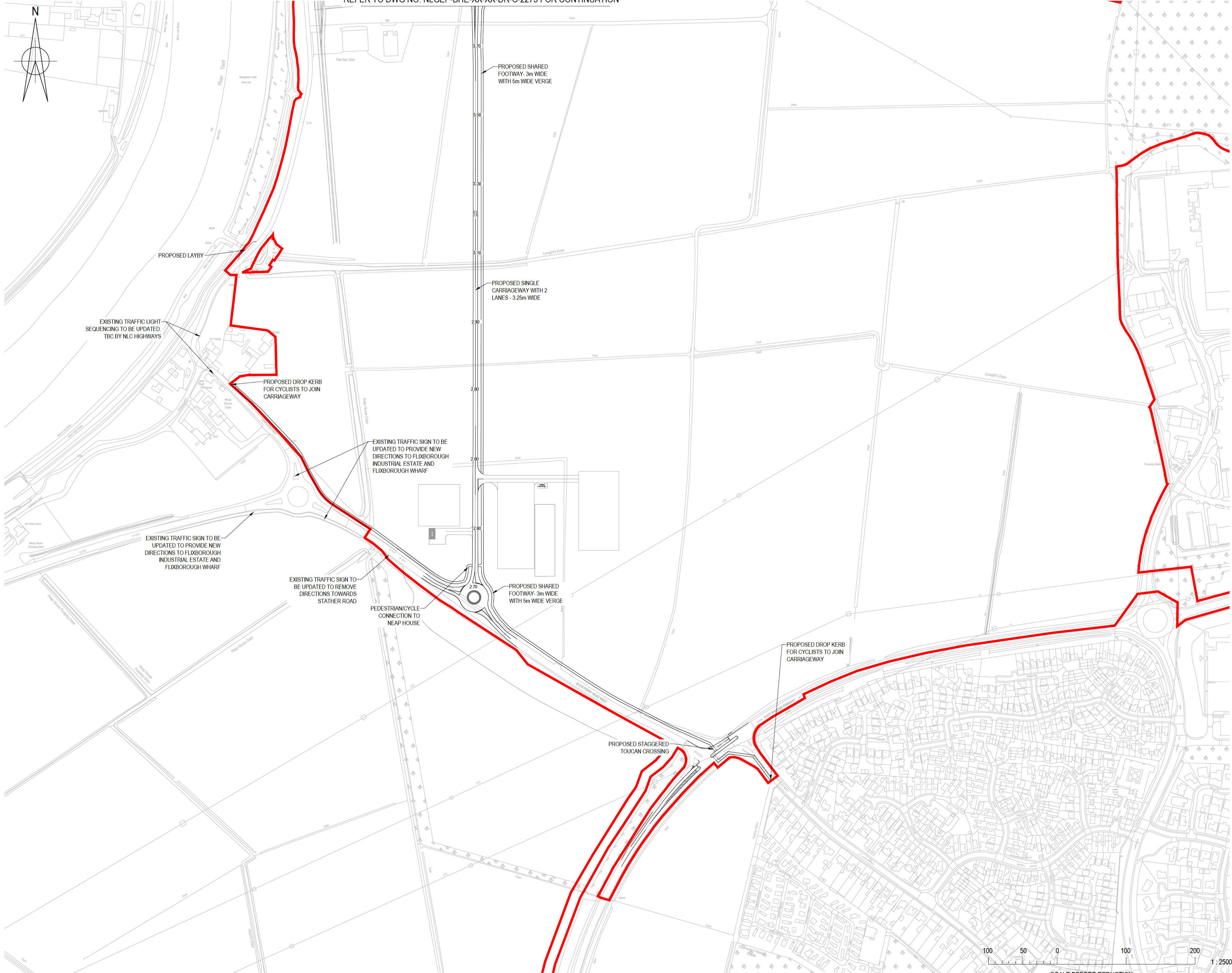

- NOTES:**
- THIS DRAWING SHOULD BE READ IN CONJUNCTION WITH ALL OTHER RELEVANT DRAWINGS AND SPECIFICATIONS.
 - DRAWINGS BASED ON THE FOLLOWING BACKGROUND INFORMATION:
 - ORDNANCE SURVEY MAPS RECEIVED © CROWN COPYRIGHT AND DATABASE RIGHTS 2021 OS LICENCE 100035409
 - THE COMPLETENESS OF THE UNDERGROUND SERVICE INFORMATION CANNOT BE GUARANTEED AND THEREFORE OTHER SERVICES MAY EXIST.

LEGEND

PROPOSED

	SITE BOUNDARY
	PROPOSED HIGHWAY LAYOUT
	PROPOSED WAITING TIME RESTRICTION
2.80	PROPOSED INDICATIVE LEVELS (mAOD) THAT CAN DEVIATE UP TO 1m HIGHER OR LOWER (BUT NO LESS THAN THE MINIMUM FRA RECOMMENDED LEVELS)

P0	ISSUED FOR DCO SUBMISSION	09.05.2022	FR	CB	CB
Rev	Description	Date	Iss'd	Rev'd	App'd

DCO SUBMISSION

Project Stage

INFORMATION

Status of Drawing

Client

Client: NORTH LINCOLNSHIRE GREEN ENERGY PARK LTD
 Consultant: BURO HAPFOLD
 Project: NORTH LINCOLNSHIRE GREEN ENERGY PARK
 Dwg Title: INDICATIVE HIGHWAYS PLAN SHEET 4

Planning Inspectorate No. EN010116	Scale@A1 1:2500	
Drawn/Designed By J.SLEEMAN	Checked By C.BYRNE	Approved By C.BYRNE
Drawing No. NLGEP-BHE-XX-XX-DR-C-2274	Revision P0	

Filepath: S:\1\2500\Projects\CAD\2022\NLGEP\BHE-XX-XX-DR-C-2275\BHE-XX-XX-DR-C-2275_Plan_P1.dwg
 Date: 09/05/2022 10:58:10 AM

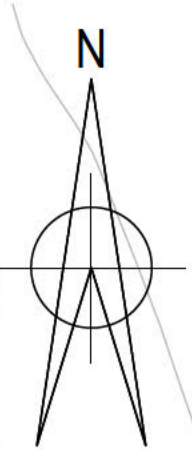

- NOTES:**
1. THIS DRAWING SHOULD BE READ IN CONJUNCTION WITH ALL OTHER RELEVANT DRAWINGS AND SPECIFICATIONS.
 2. DRAWINGS BASED ON THE FOLLOWING BACKGROUND INFORMATION:
 - ORDNANCE SURVEY MAPS RECEIVED @ CROWN COPYRIGHT AND DATABASE RIGHTS 2021 OS LICENCE 100035409
 3. THE COMPLETENESS OF THE UNDERGROUND SERVICE INFORMATION CANNOT BE GUARANTEED AND THEREFORE OTHER SERVICES MAY EXIST.

LEGEND

PROPOSED	
	SITE BOUNDARY
	PROPOSED HIGHWAY LAYOUT
	PROPOSED WAITING TIME RESTRICTION
2.80	PROPOSED INDICATIVE LEVELS (mAOD) THAT CAN DEVIATE UP TO 1m HIGHER OR LOWER (BUT NO LESS THAN THE MINIMUM FRA RECOMMENDED LEVELS)

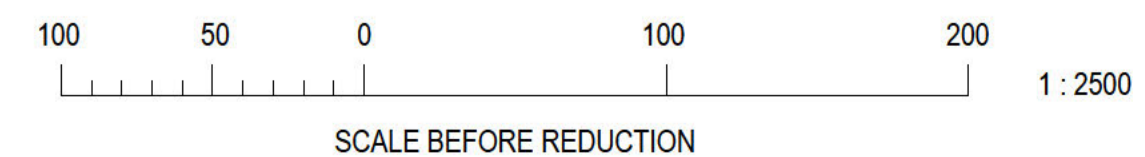
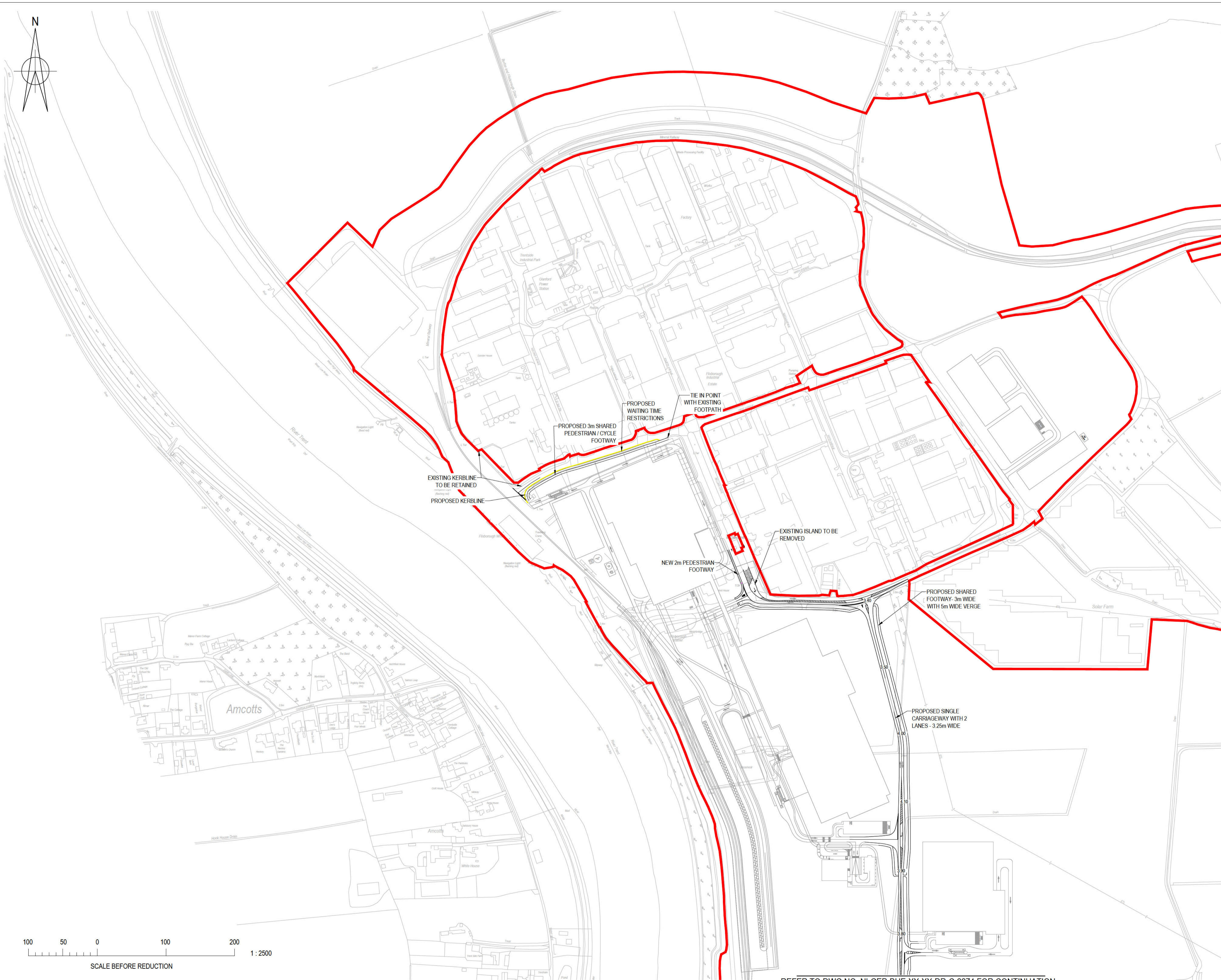

P0	ISSUED FOR DCO SUBMISSION	09.05.2022	FR	CB	CB
Rev	Description	Date	Iss'd	Rev'd	App'd

DCO SUBMISSION

Project Stage

INFORMATION

Status of Drawing

Client

NORTH LINCOLNSHIRE GREEN ENERGY PARK
Level 33, Euston Tower, 296 Euston Road, London, NW1 3DF

LD A DESIGN GSDA FICHTNER ERM

BURO HAPFOLD northern planners bowland ecology

Client **NORTH LINCOLNSHIRE GREEN ENERGY PARK LTD**
 Consultant **BURO HAPFOLD**
 Project **NORTH LINCOLNSHIRE GREEN ENERGY PARK**
 Dwg Title **INDICATIVE HIGHWAYS PLAN SHEET 5**

Planning Inspectorate No. EN010116	Scale@A1 1:2500
Drawn/Designed By J.SLEEMAN	Checked By C.BYRNE
Approved By C.BYRNE	Revision P0
Drawing No. NLGP-BHE-XX-XX-DR-C-2275	

REFER TO DWG NO. NLGP-BHE-XX-XX-DR-C-2274 FOR CONTINUATION

Appendix G Vehicle Swept Path Analysis

PLASTIC RECYCLING FACILITY

EAT EXCHANGER BUILDING

POST PROCESSED STORAGE

STORAGE AREA
PRE-PROCESSED MATERIAL

ADMIN



Standard Design Vehicle (SDV)
 Overall Length: 4.800m
 Overall Width: 2.200m
 Overall Body Height: 1.950m
 Min Body Ground Clearance: 0.200m
 Track Width: 2.200m
 Lock to lock time: 4.00s
 Wall to Wall Turning Radius: 4.000m

CYCLE SHELTER

WEIGHBRIDGE

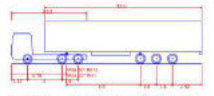

Max Legal Length (MLL) Articulated Vehicle (16.5m)
 Overall Length: 16.500m
 Overall Width: 2.500m
 Overall Body Height: 3.850m
 Min Body Ground Clearance: 0.411m
 Max Track Width: 2.500m
 Lock to lock time: 6.00s
 50% to 50% Turning Radius: 8.500m

BURO HAPPOLD

Project: North Lincolnshire Green Energy Park
 Sketch Title: Plastic Recycling Facility Tracking

Project Number: 046658
 Sketch Number: 0046658/TRK01

Status:
 Date: 05/10/2021
 Initials: VL
 Revision:

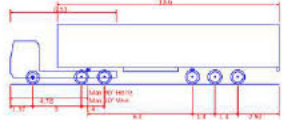
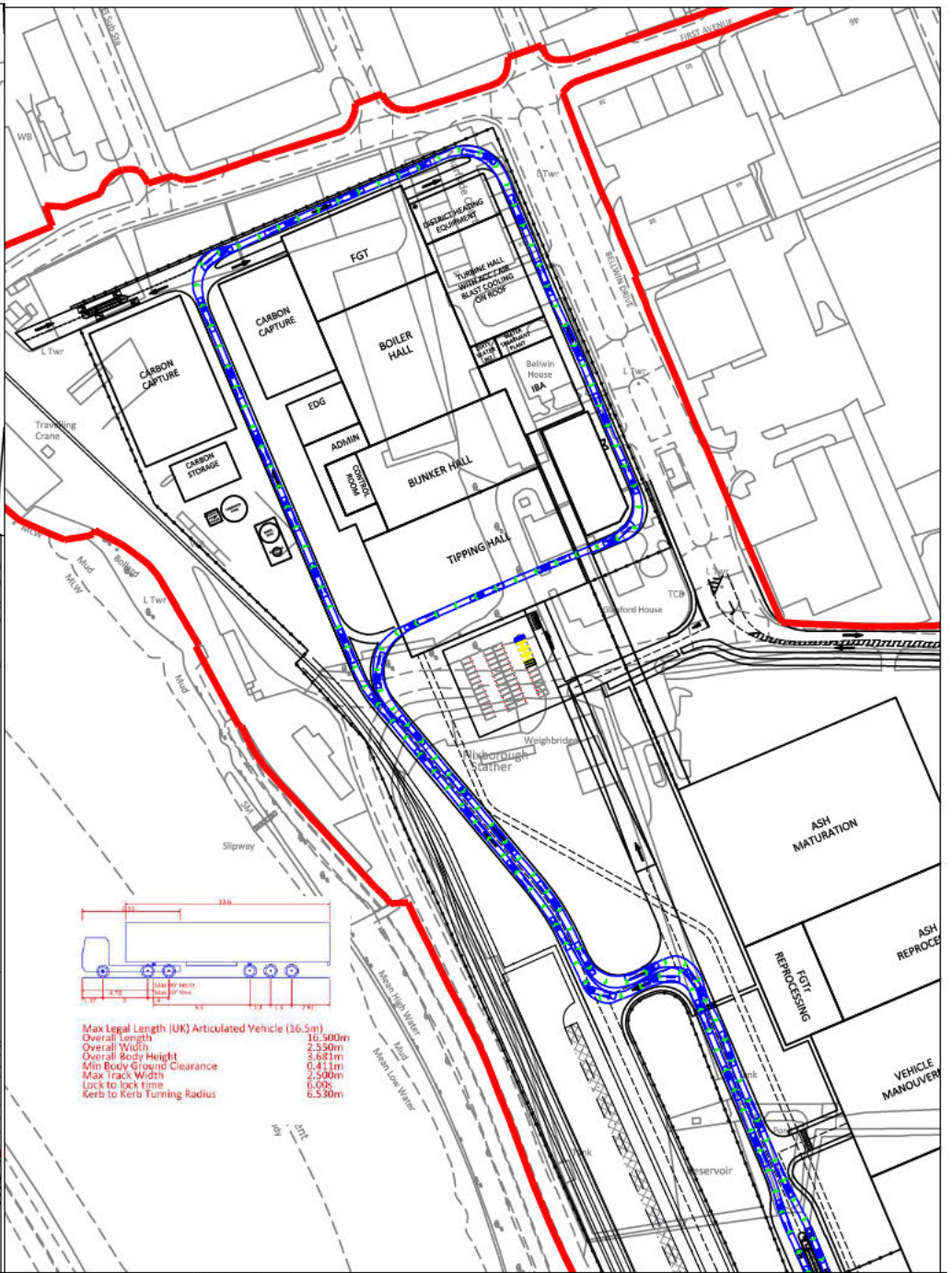
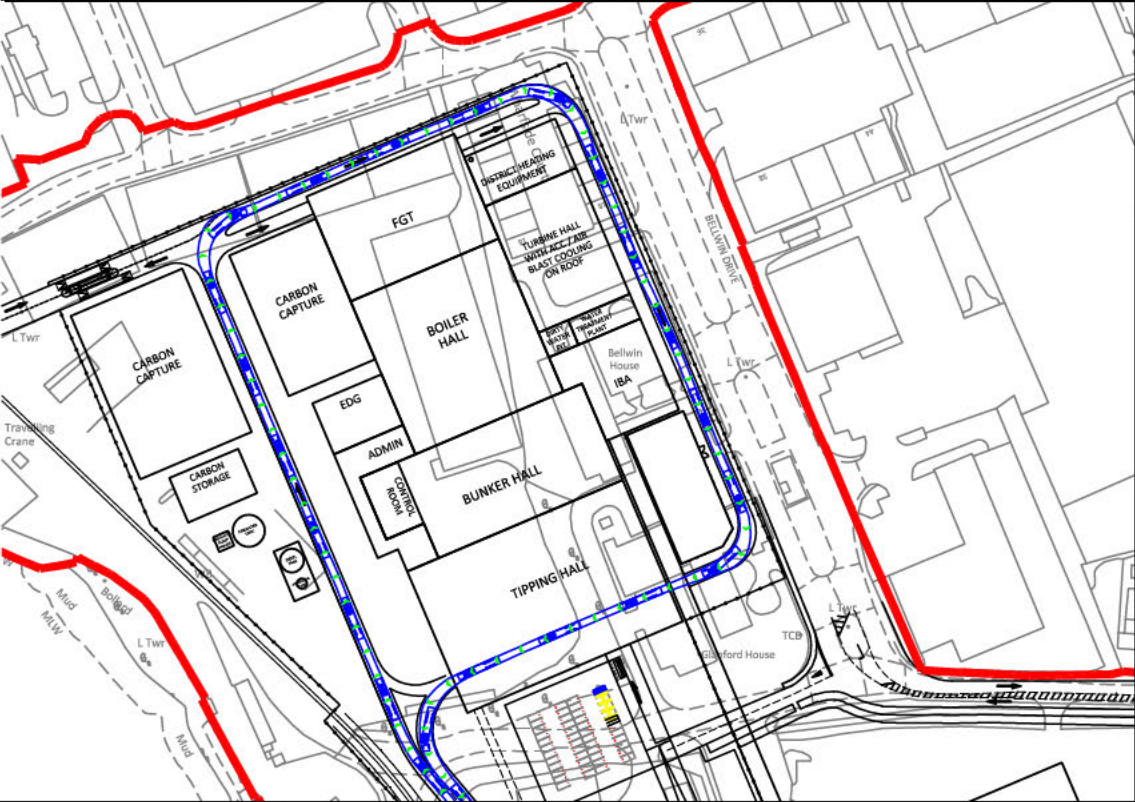
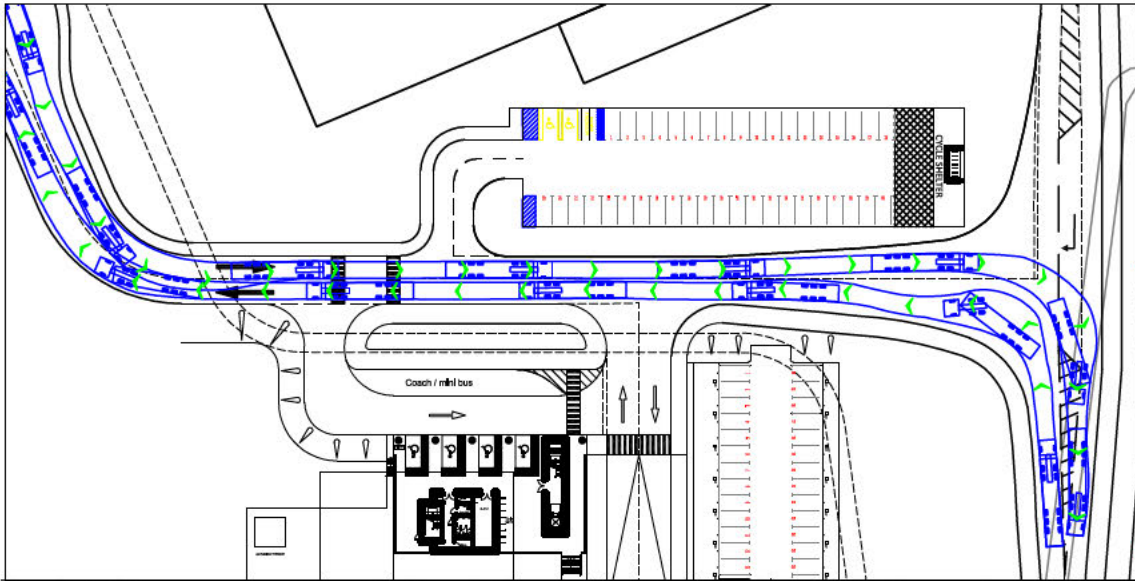

Max Legal Length (UK) Articulated Vehicle (16.5m)
 Overall Length 16.500m
 Overall Width 2.530m
 Overall Body Height 3.631m
 Min Body Ground Clearance 0.411m
 Max track Width 2.500m
 Lock to lock time 6.00s
 Kerb to Kerb Turning Radius 6.530m

	Project: North Lincolnshire Green Energy Park	Project Number: 046658	Status:		
	Sketch Title: ERF Building Tracking	Sketch Number: 0046658/TRK02	Date: 05/10/2021	Initials: VL	Revision:

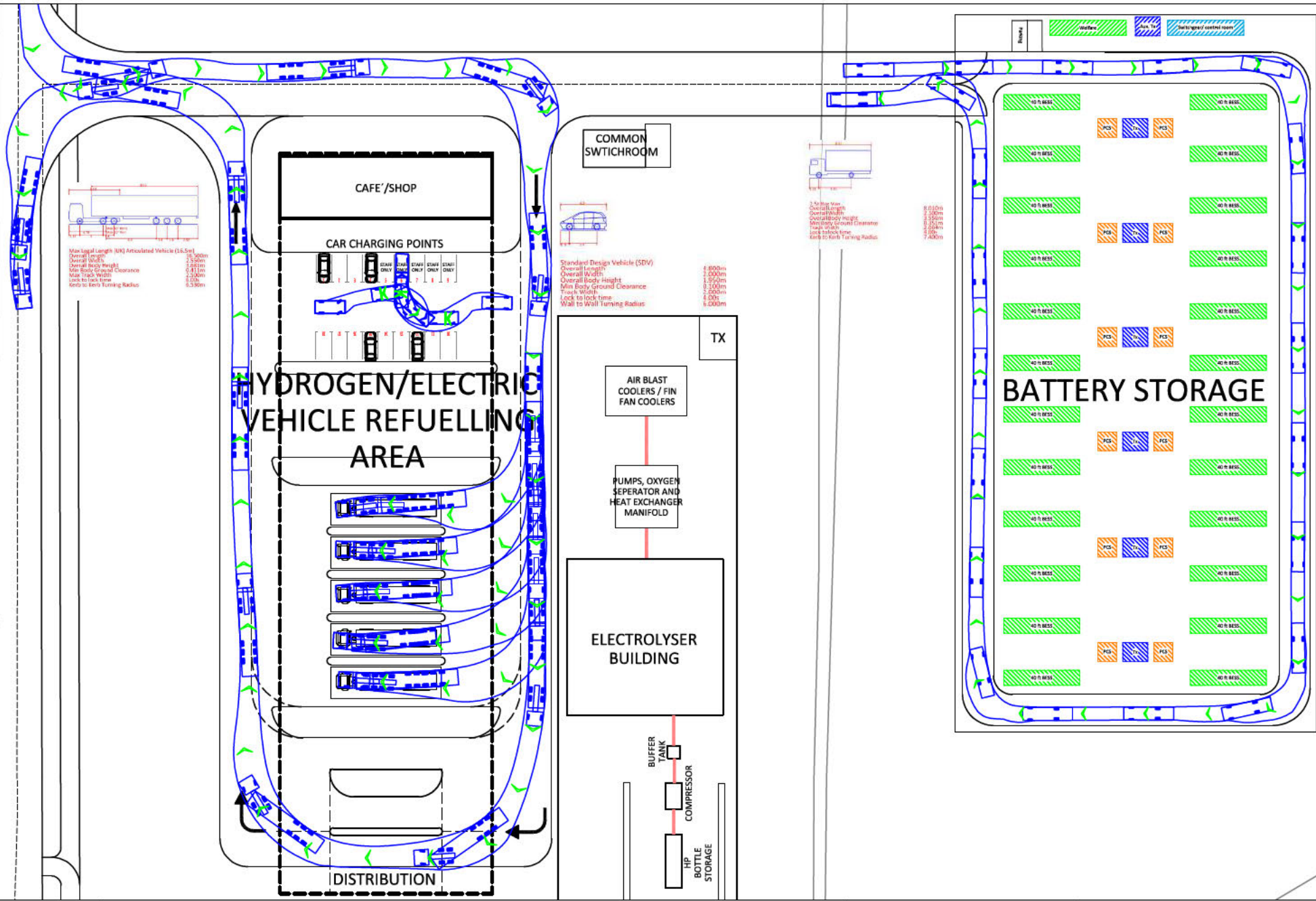

Project: North Lincolnshire Green Energy Park

Sketch Title: Electric Vehicle and Hydrogen Re-fuelling Station Tracking

Project Number: 046658

Sketch Number: 0046658/TRK03

Status:

Date: 05/10/2021

Initials: VL

Revision:

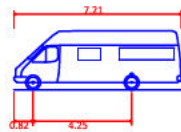
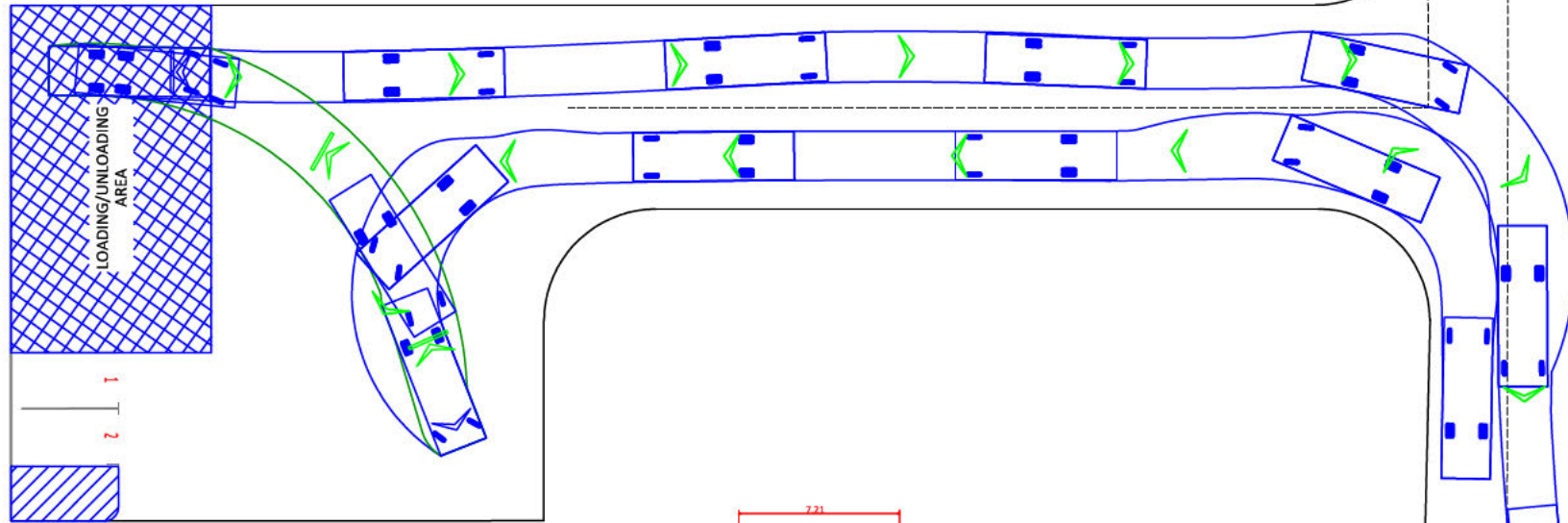

7.5t Panel Van
 Overall Length 7.210m
 Overall Width 2.192m
 Overall Body Height 2.544m
 Min Body Ground Clearance 0.316m
 Track Width 1.865m
 Lock to lock time 4.00s
 Kerb to Kerb Turning Radius 7.400m



Project: North Lincolnshire Green Energy Park

Project Number: 046658

Status:

Sketch Title: Gas AGI Building South of Site Tracking

Sketch Number: 0046658/TRK04

Date: 05/10/2021

Initials: VL

Revision:

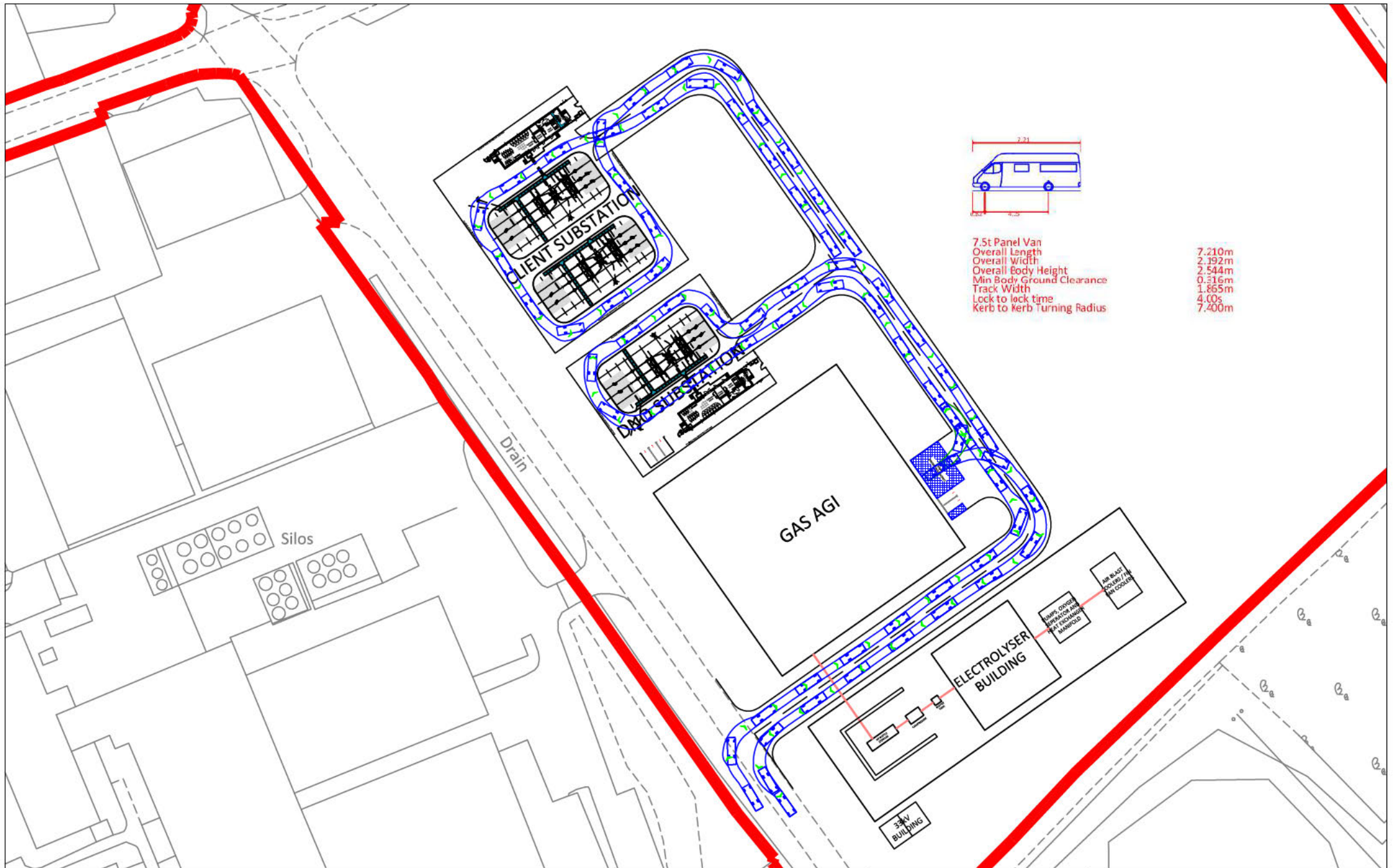

Project: North Lincolnshire Green Energy Park

Sketch Title: GAS AGI North of Site Tracking

Project Number: 046658

Sketch Number: 0046658/TRK05

Status:

Date: 05/10/2021

Initials: VL

Revision:

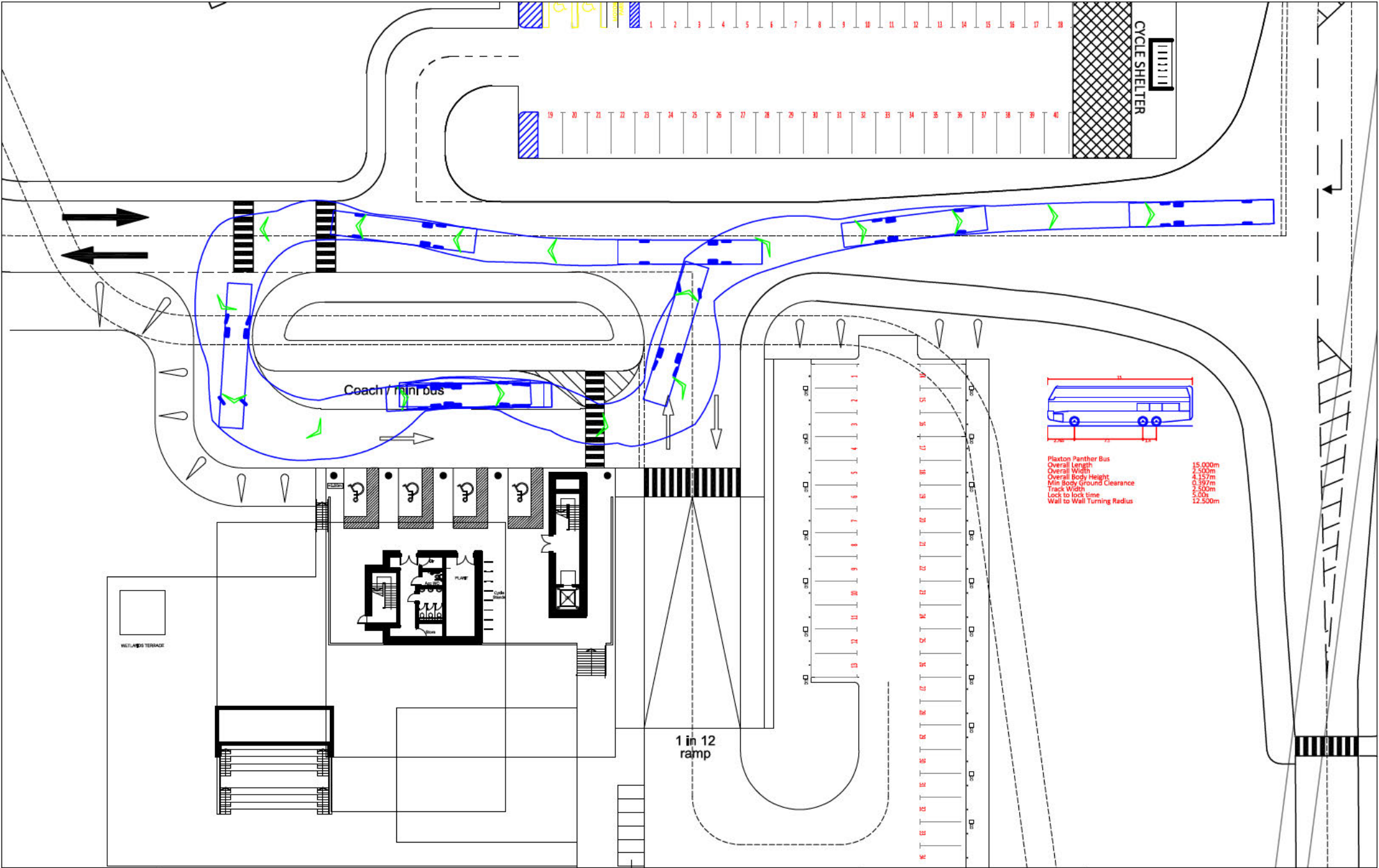

	Project:	North Lincolnshire Green Energy Park	Project Number:	046658	Status:	
	Sketch Title:	Visitor Centre Tracking	Sketch Number:	0046658/TRK06	Date:	05/10/2021
					Initials:	VL
					Revision:	

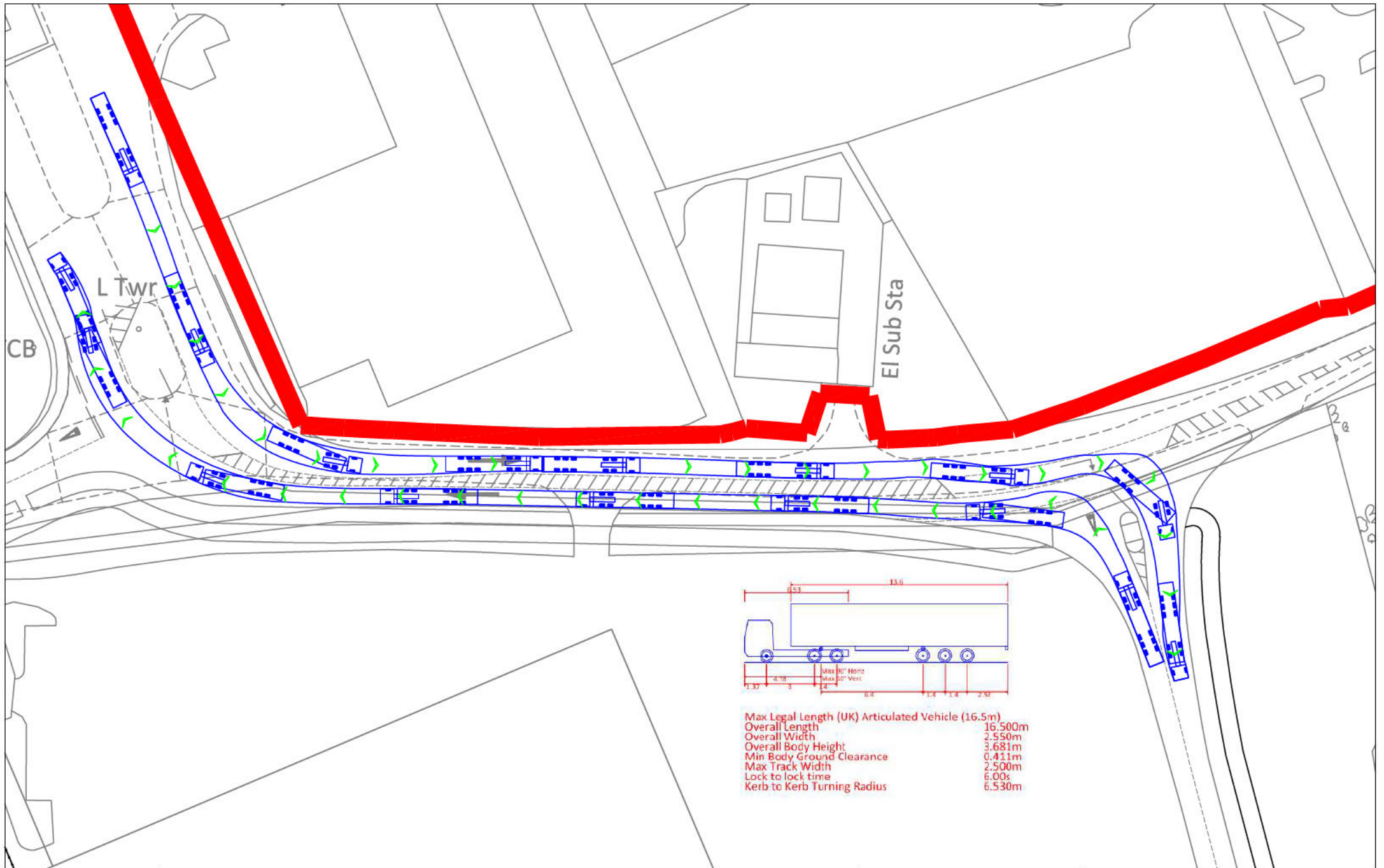

	Project: North Lincolnshire Green Energy Park	Project Number: 046658	Status:		
	Sketch Title: New Link Road / Stather Road Priority Junction	Sketch Number: 0046658/TRK07	Date: 05/10/2021	Initials: VL	Revision:

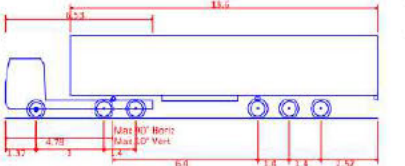
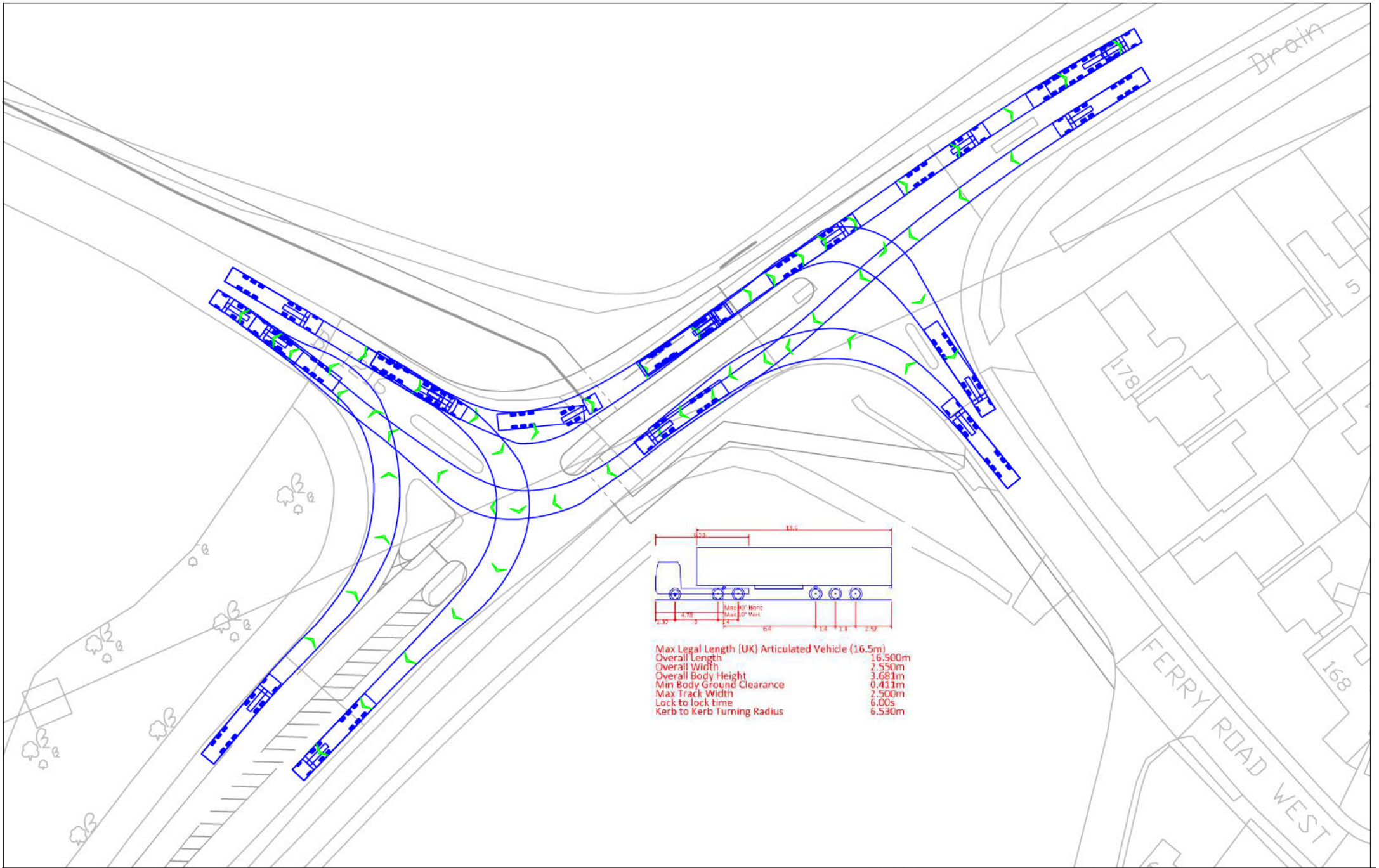

Max Legal Length (UK) Articulated Vehicle (16.5m)
 Overall Length 16.500m
 Overall Width 2.550m
 Overall Body Height 3.681m
 Min Body Ground Clearance 0.411m
 Max Track Width 2.500m
 Lock to lock time 6.00s
 Kerb to Kerb Turning Radius 6.530m

	Project: North Lincolnshire Green Energy Park	Project Number: 046658	Status:	
	Sketch Title: A1077 / Ferry Road West Signalised Junction Tracking	Sketch Number: 0046658/TRK08	Date: 05/10/2021	Initials: VL

Appendix H Percentage Impact Assessment

NLGEP DCO Application - Percentage Change in Traffic on Local Highway Network

Junction	Time	Link Name	2020 Observed Flows	2022 Baseline *	2028 Baseline (10%LL) **	2028 Baseline (CD) + Dev	Dev	2028 - % change	2033 Baseline (30% LL)	2033 Baseline (CD) + Dev	Dev	2033 - % change	2038 Baseline (50% LL) **	2038 Baseline (CD) + Dev	Dev	2038 - % change
Skippingdale Roundabout	AM	A1077 South	810	969	1309	1324	15	1%	1543	1558	15	1%	1793	1808	15	1%
		Holyrood Drive	247	296	318	319	1	0%	340	341	1	0%	363	363	1	0%
		A1077 North	1044	1248	1680	1693	13	1%	1885	1898	13	1%	2100	2113	13	1%
	PM	Luneburg Way	512	612	749	750	1	0%	755	756	1	0%	771	772	1	0%
		A1077 South	1012	1169	1454	1477	23	2%	1681	1704	23	1%	1904	1927	23	1%
		Holyrood Drive	725	838	874	874	1	0%	925	925	1	0%	973	974	1	0%
A1077 South / A18 / A1077	AM	A1077 North	1161	1341	1692	1704	12	1%	1853	1865	12	1%	2013	2025	12	1%
		Luneburg Way	665	768	879	889	10	1%	894	904	10	1%	908	919	10	1%
		A1077 South	1490	1782	2436	2467	32	1%	2804	2836	32	1%	3181	3212	32	1%
		A18 Doncaster Road	781	934	1103	1106	3	0%	1216	1219	3	0%	1331	1334	3	0%
	PM	A1077	999	1194	1675	1714	40	2%	1931	1970	40	2%	2196	2236	40	2%
		A18 Kingsway	1626	1945	2303	2308	5	0%	2434	2439	5	0%	2566	2571	5	0%
M181 / M180	AM	A1077 South	1548	1787	2325	2355	31	1%	2672	2702	31	1%	2797	2827	31	1%
		A18 Doncaster Road	967	1116	1248	1253	5	0%	1343	1348	5	0%	1399	1404	5	0%
		A1077	1196	1382	1789	1830	41	2%	2028	2068	41	2%	1997	2037	41	2%
		A18 Kingsway	1989	2297	2583	2588	5	0%	2708	2713	5	0%	2823	2829	5	0%
	PM	M180 (West) to M181	836	999	1041	1044	3	0%	1084	1087	3	0%	1127	1130	3	0%
		M180 (East) to M181	194	233	408	422	14	4%	592	606	14	2%	775	790	14	2%
M181 to M180 (West)	M181 to M180 (West)	558	667	760	771	11	1%	875	886	11	1%	989	1001	11	1%	
	M181 to M180 (East)	127	152	173	176	3	2%	200	203	3	1%	227	230	3	1%	
	M180 (West) to M181	543	627	657	662	5	1%	699	704	5	1%	741	746	5	1%	
	M180 (East) to M181	185	214	304	320	15	5%	429	444	15	4%	556	571	15	3%	
M181 to M180 (East)	M181 to M180 (West)	712	822	962	970	8	1%	1102	1110	8	1%	1068	1075	8	1%	
	M181 to M180 (East)	218	252	294	296	2	1%	335	338	2	1%	325	327	2	1%	

* 2021 Baseline flows include COVID factor adjustment agreed with NLC/HE

** 2028 Baseline includes 600 dwellings for Linc Lakes, 2038 includes 3,000 dwellings for Linc Lakes

Appendix I LINSIG Results - A1077 / B1216 Ferry Road West Signal Junction

Full Input Data And Results
Full Input Data And Results

User and Project Details

Project:	Scunthorpe
Title:	A1077 + B1216 junction
Location:	Junction of A1077 with B1216
Client:	Jeanne Watrin
Date Started:	5th January 2021
Additional detail:	
File name:	Phoenix Parkway_with TOUCAN option C v2.lsg3x
Author:	Francis King
Company:	Buro Happold
Address:	

Network Layout Diagram

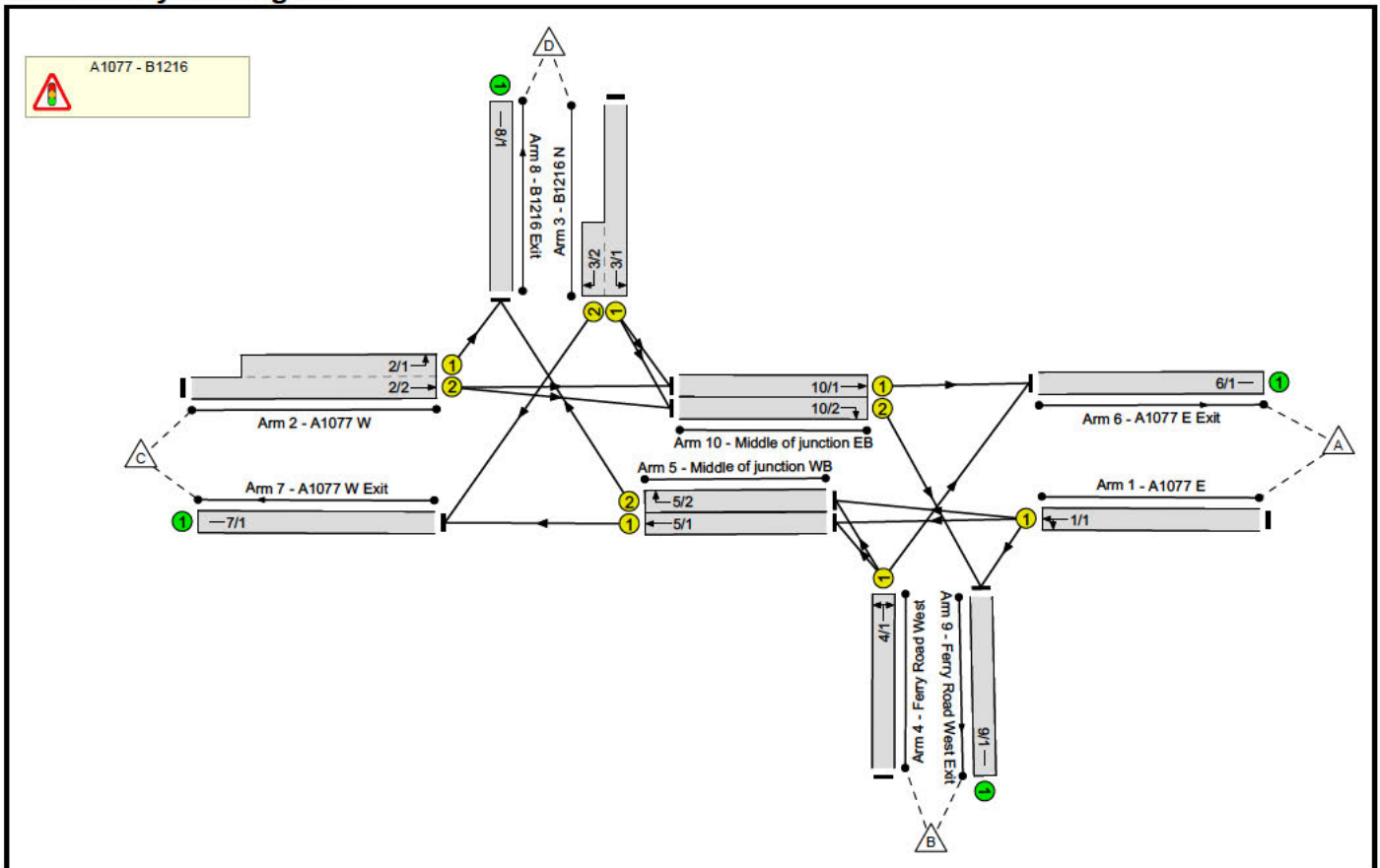

Phase Diagram

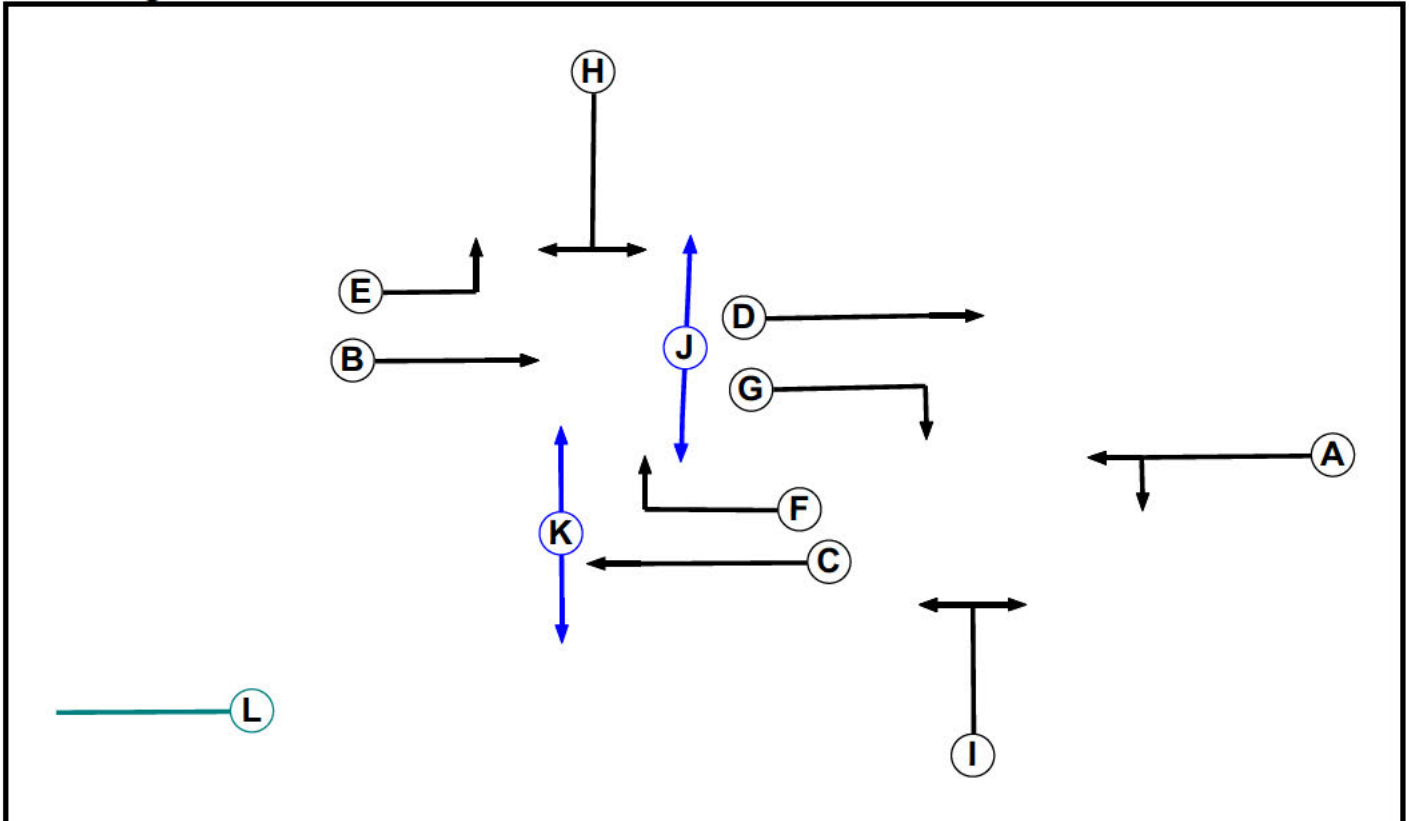

Phase Input Data

Phase Name	Phase Type	Assoc. Phase	Street Min	Cont Min
A	Traffic		7	7
B	Traffic		7	7
C	Traffic		7	7
D	Traffic		7	7
E	Traffic		7	7
F	Traffic		7	7
G	Traffic		7	7
H	Traffic		7	7
I	Traffic		7	7
J	Pedestrian		6	6
K	Pedestrian		6	6
L	Dummy		7	7

Full Input Data And Results

Phase Intergrens Matrix

		Starting Phase											
		A	B	C	D	E	F	G	H	I	J	K	L
Terminating Phase	A	-	-	-	-	-	7	-	7	-	-	7	-
	B	-	-	-	-	6	-	7	-	8	-	6	-
	C	-	-	-	-	-	-	6	-	-	5	-	-
	D	-	-	-	-	-	-	-	6	-	-	-	-
	E	-	-	-	-	-	5	-	-	-	-	-	5
	F	-	6	-	-	6	-	-	5	-	-	5	-
	G	6	-	-	-	-	-	-	5	-	-	-	-
	H	-	5	7	-	-	7	-	-	7	-	5	-
	I	6	-	-	6	-	-	5	-	-	-	-	5
	J	-	8	-	-	-	-	-	8	-	-	-	-
	K	-	-	7	-	-	7	-	-	-	-	-	-
	L	-	-	-	-	-	-	-	-	-	-	-	-

Phases in Stage

Stage No.	Phases in Stage
1	A B C D E
2	C D F G J
3	C D F G
4	E H I K
5	C D F G L
6	D E G H
7	C F I

Stage Diagram

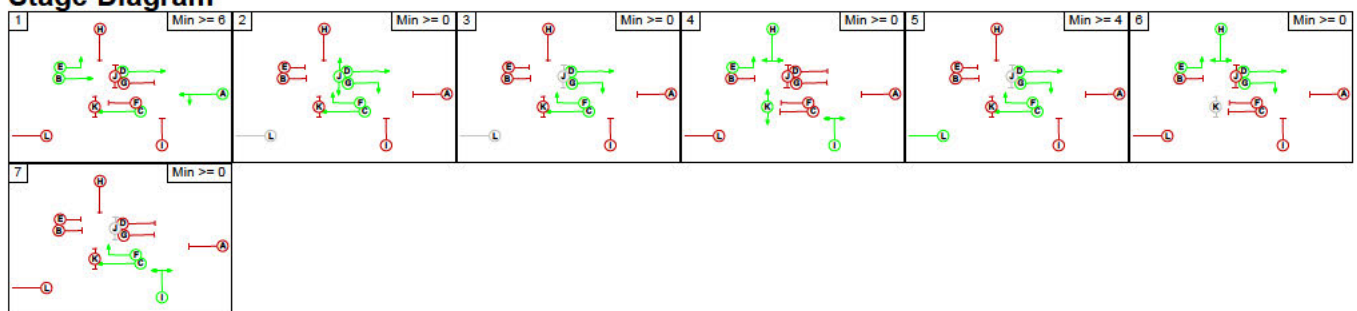

Full Input Data And Results

Phase Delays

Term. Stage	Start Stage	Phase	Type	Value	Cont value
1	4	C	Losing	6	6
1	4	D	Losing	6	6
1	6	C	Losing	3	3
1	7	D	Losing	3	3
2	4	C	Losing	2	2
2	4	D	Losing	2	2
2	4	F	Losing	2	2
2	4	G	Losing	2	2
4	1	B	Gaining absolute	6	6
4	2	F	Gaining absolute	8	8
4	2	G	Gaining absolute	6	6
4	5	F	Gaining absolute	8	8
4	5	G	Gaining absolute	6	6
4	6	G	Gaining absolute	6	6
4	7	F	Gaining absolute	8	8
6	1	B	Gaining absolute	6	6
6	1	G	Losing	3	3
6	2	F	Gaining absolute	8	8
6	5	F	Gaining absolute	8	8
6	7	C	Gaining absolute	8	8
6	7	F	Gaining absolute	9	9
7	1	F	Losing	3	3
7	2	G	Gaining absolute	6	6
7	5	G	Gaining absolute	6	6
7	6	G	Gaining absolute	6	6

Prohibited Stage Change

		To Stage						
		1	2	3	4	5	6	7
From Stage	1	8	7	12	7	9	9	
	2	8	X	8	0	8	6	
	3	6	0	6	0	6	6	
	4	7	8	7	8	6	8	
	5	6	0	0	6	6	6	
	6	9	8	7	6	8	9	
	7	9	6	6	6	6	6	

Full Input Data And Results

Give-Way Lane Input Data

Junction: A1077 - B1216

There are no Opposed Lanes in this Junction

Full Input Data And Results

Lane Input Data

Junction: A1077 - B1216												
Lane	Lane Type	Phases	Start Disp.	End Disp.	Physical Length (PCU)	Sat Flow Type	Def User Saturation Flow (PCU/Hr)	Lane Width (m)	Gradient	Nearside Lane	Turns	Turning Radius (m)
1/1 (A1077 E)	U	A	2	3	60.0	Geom	-	4.50	0.00	Y	Arm 5 Ahead	Inf
											Arm 9 Left	19.70
2/1 (A1077 W)	U	E	2	3	27.8	Geom	-	4.50	0.00	Y	Arm 8 Left	23.50
2/2 (A1077 W)	U	B	2	3	60.0	Geom	-	4.30	0.00	Y	Arm 10 Ahead	Inf
3/1 (B1216 N)	U	H	2	3	60.0	Geom	-	3.60	0.00	Y	Arm 10 Left	24.00
3/2 (B1216 N)	U	H	2	3	5.0	Geom	-	3.60	0.00	Y	Arm 7 Right	27.50
4/1 (Ferry Road West)	U	I	2	3	60.0	Geom	-	3.70	0.00	Y	Arm 5 Left	19.70
											Arm 6 Right	22.00
5/1 (Middle of junction WB)	U	C	2	3	14.0	Geom	-	3.95	0.00	Y	Arm 7 Ahead	Inf
5/2 (Middle of junction WB)	U	F	2	3	14.0	Geom	-	3.95	0.00	Y	Arm 8 Right	15.40
6/1 (A1077 E Exit)	U		2	3	60.0	Inf	-	-	-	-	-	-
7/1 (A1077 W Exit)	U		2	3	60.0	Inf	-	-	-	-	-	-
8/1 (B1216 Exit)	U		2	3	60.0	Inf	-	-	-	-	-	-
9/1 (Ferry Road West Exit)	U		2	3	60.0	Inf	-	-	-	-	-	-
10/1 (Middle of junction EB)	U	D	2	3	12.0	Geom	-	3.60	0.00	Y	Arm 6 Ahead	Inf
10/2 (Middle of junction EB)	U	G	2	3	12.0	Geom	-	3.60	0.00	Y	Arm 9 Right	18.00

Full Input Data And Results

Traffic Flow Groups

Flow Group	Start Time	End Time	Duration	Formula
1 '2028 + CD (10% of Lincolnshire Lakes) + ERF AM'	08:00	09:00	01:00	
2 '2028 + CD (10% of Lincolnshire Lakes) + ERF PM'	17:00	18:00	01:00	
3 '2033 + CD (30% of Lincolnshire Lakes) + ERF AM'	08:00	09:00	01:00	
4 '2033 + CD (30% of Lincolnshire Lakes) + ERF PM'	17:00	18:00	01:00	
5: '2038 + CD (50% of Lincolnshire Lakes) + ERF AM'	08:00	09:00	01:00	
6: '2038 + CD (50% of Lincolnshire Lakes) + ERF PM'	17:00	18:00	01:00	

Scenario 1: '7' (FG3: '2033 + CD (30% of Lincolnshire Lakes) + ERF AM', Plan 1: 'Network Control Plan 1')

Traffic Flows, Desired

Desired Flow :

	Destination					
		A	B	C	D	Tot.
Origin	A	0	14	472	45	531
	B	5	0	66	44	115
	C	969	66	0	254	1289
	D	52	31	141	0	224
	Tot.	1026	111	679	343	2159

Traffic Lane Flows

Lane	Scenario 1: 7
Junction: A1077 - B1216	
1/1	531
2/1 (short)	254
2/2 (with short)	1289(In) 1035(Out)
3/1 (with short)	224(In) 83(Out)
3/2 (short)	141
4/1	115
5/1	538
5/2	89
6/1	1026
7/1	679
8/1	343
9/1	111
10/1	1021
10/2	97

Full Input Data And Results

Lane Saturation Flows

Junction: A1077 - B1216								
Lane	Lane Width (m)	Gradient	Nearside Lane	Allowed Turns	Turning Radius (m)	Turning Prop.	Sat Flow (PCU/Hr)	Flared Sat Flow (PCU/Hr)
1/1 (A1077 E)	4.50	0.00	Y	Arm 5 Ahead	Inf	97.4 %	2061	2061
				Arm 9 Left	19.70	2.6 %		
2/1 (A1077 W)	4.50	0.00	Y	Arm 8 Left	23.50	100.0 %	1941	1941
2/2 (A1077 W)	4.30	0.00	Y	Arm 10 Ahead	Inf	100.0 %	2045	2045
3/1 (B1216 N)	3.60	0.00	Y	Arm 10 Left	24.00	100.0 %	1859	1859
3/2 (B1216 N)	3.60	0.00	Y	Arm 7 Right	27.50	100.0 %	1873	1873
4/1 (Ferry Road West)	3.70	0.00	Y	Arm 5 Left	19.70	95.7 %	1845	1845
				Arm 6 Right	22.00	4.3 %		
5/1 (Middle of junction WB)	3.95	0.00	Y	Arm 7 Ahead	Inf	100.0 %	2010	2010
5/2 (Middle of junction WB)	3.95	0.00	Y	Arm 8 Right	15.40	100.0 %	1832	1832
6/1 (A1077 E Exit Lane 1)				Infinite Saturation Flow			Inf	Inf
7/1 (A1077 W Exit Lane 1)				Infinite Saturation Flow			Inf	Inf
8/1 (B1216 Exit Lane 1)				Infinite Saturation Flow			Inf	Inf
9/1 (Ferry Road West Exit Lane 1)				Infinite Saturation Flow			Inf	Inf
10/1 (Middle of junction EB)	3.60	0.00	Y	Arm 6 Ahead	Inf	100.0 %	1975	1975
10/2 (Middle of junction EB)	3.60	0.00	Y	Arm 9 Right	18.00	100.0 %	1823	1823

Scenario 2: '8' (FG4: '2033 + CD (30% of Lincolnshire Lakes) + ERF PM', Plan 1: 'Network Control Plan 1')

Traffic Flows, Desired

Desired Flow :

	Destination					
	A	B	C	D	Tot.	
Origin	A	0	11	971	68	1050
	B	7	0	107	74	188
	C	588	65	0	147	800
	D	51	44	199	0	294
	Tot.	646	120	1277	289	2332

Full Input Data And Results

Traffic Lane Flows

Lane	Scenario 2: 8
Junction: A1077 - B1216	
1/1	1050
2/1 (short)	147
2/2 (with short)	800(In) 653(Out)
3/1 (with short)	294(In) 95(Out)
3/2 (short)	199
4/1	188
5/1	1078
5/2	142
6/1	646
7/1	1277
8/1	289
9/1	120
10/1	639
10/2	109

Full Input Data And Results

Lane Saturation Flows

Junction: A1077 - B1216								
Lane	Lane Width (m)	Gradient	Nearside Lane	Allowed Turns	Turning Radius (m)	Turning Prop.	Sat Flow (PCU/Hr)	Flared Sat Flow (PCU/Hr)
1/1 (A1077 E)	4.50	0.00	Y	Arm 5 Ahead Arm 9 Left	Inf 19.70	99.0 % 1.0 %	2063	2063
2/1 (A1077 W)	4.50	0.00	Y	Arm 8 Left	23.50	100.0 %	1941	1941
2/2 (A1077 W)	4.30	0.00	Y	Arm 10 Ahead	Inf	100.0 %	2045	2045
3/1 (B1216 N)	3.60	0.00	Y	Arm 10 Left	24.00	100.0 %	1859	1859
3/2 (B1216 N)	3.60	0.00	Y	Arm 7 Right	27.50	100.0 %	1873	1873
4/1 (Ferry Road West)	3.70	0.00	Y	Arm 5 Left Arm 6 Right	19.70 22.00	96.3 % 3.7 %	1845	1845
5/1 (Middle of junction WB)	3.95	0.00	Y	Arm 7 Ahead	Inf	100.0 %	2010	2010
5/2 (Middle of junction WB)	3.95	0.00	Y	Arm 8 Right	15.40	100.0 %	1832	1832
6/1 (A1077 E Exit Lane 1)	Infinite Saturation Flow						Inf	Inf
7/1 (A1077 W Exit Lane 1)	Infinite Saturation Flow						Inf	Inf
8/1 (B1216 Exit Lane 1)	Infinite Saturation Flow						Inf	Inf
9/1 (Ferry Road West Exit Lane 1)	Infinite Saturation Flow						Inf	Inf
10/1 (Middle of junction EB)	3.60	0.00	Y	Arm 6 Ahead	Inf	100.0 %	1975	1975
10/2 (Middle of junction EB)	3.60	0.00	Y	Arm 9 Right	18.00	100.0 %	1823	1823

Scenario 3: '9' (FG5: '2038 + CD (50% of Lincolnshire Lakes) + ERF AM', Plan 1: 'Network Control Plan 1')

Traffic Flows, Desired

Desired Flow :

	Destination					
	A	B	C	D	Tot.	
Origin	A	0	14	536	53	603
	B	5	0	66	41	112
	C	1136	66	0	270	1472
	D	56	31	146	0	233
	Tot.	1197	111	748	364	2420

Full Input Data And Results

Traffic Lane Flows

Lane	Scenario 3: 9
Junction: A1077 - B1216	
1/1	603
2/1 (short)	270
2/2 (with short)	1472(In) 1202(Out)
3/1 (with short)	233(In) 87(Out)
3/2 (short)	146
4/1	112
5/1	602
5/2	94
6/1	1197
7/1	748
8/1	364
9/1	111
10/1	1192
10/2	97

Full Input Data And Results

Lane Saturation Flows

Junction: A1077 - B1216								
Lane	Lane Width (m)	Gradient	Nearside Lane	Allowed Turns	Turning Radius (m)	Turning Prop.	Sat Flow (PCU/Hr)	Flared Sat Flow (PCU/Hr)
1/1 (A1077 E)	4.50	0.00	Y	Arm 5 Ahead Arm 9 Left	Inf 19.70	97.7 % 2.3 %	2061	2061
2/1 (A1077 W)	4.50	0.00	Y	Arm 8 Left	23.50	100.0 %	1941	1941
2/2 (A1077 W)	4.30	0.00	Y	Arm 10 Ahead	Inf	100.0 %	2045	2045
3/1 (B1216 N)	3.60	0.00	Y	Arm 10 Left	24.00	100.0 %	1859	1859
3/2 (B1216 N)	3.60	0.00	Y	Arm 7 Right	27.50	100.0 %	1873	1873
4/1 (Ferry Road West)	3.70	0.00	Y	Arm 5 Left Arm 6 Right	19.70 22.00	95.5 % 4.5 %	1845	1845
5/1 (Middle of junction WB)	3.95	0.00	Y	Arm 7 Ahead	Inf	100.0 %	2010	2010
5/2 (Middle of junction WB)	3.95	0.00	Y	Arm 8 Right	15.40	100.0 %	1832	1832
6/1 (A1077 E Exit Lane 1)	Infinite Saturation Flow						Inf	Inf
7/1 (A1077 W Exit Lane 1)	Infinite Saturation Flow						Inf	Inf
8/1 (B1216 Exit Lane 1)	Infinite Saturation Flow						Inf	Inf
9/1 (Ferry Road West Exit Lane 1)	Infinite Saturation Flow						Inf	Inf
10/1 (Middle of junction EB)	3.60	0.00	Y	Arm 6 Ahead	Inf	100.0 %	1975	1975
10/2 (Middle of junction EB)	3.60	0.00	Y	Arm 9 Right	18.00	100.0 %	1823	1823

Scenario 4: '10' (FG6: '2038 + CD (50% of Lincolnshire Lakes) + ERF PM', Plan 1: 'Network Control Plan 1')

Traffic Flows, Desired

Desired Flow :

	Destination					
	A	B	C	D	Tot.	
Origin	A	0	11	1094	68	1173
	B	7	0	107	74	188
	C	683	65	0	153	901
	D	58	44	209	0	311
	Tot.	748	120	1410	295	2573

Full Input Data And Results

Traffic Lane Flows

Lane	Scenario 4: 10
Junction: A1077 - B1216	
1/1	1173
2/1 (short)	153
2/2 (with short)	901(In) 748(Out)
3/1 (with short)	311(In) 102(Out)
3/2 (short)	209
4/1	188
5/1	1201
5/2	142
6/1	748
7/1	1410
8/1	295
9/1	120
10/1	741
10/2	109

Lane Saturation Flows

Junction: A1077 - B1216								
Lane	Lane Width (m)	Gradient	Nearside Lane	Allowed Turns	Turning Radius (m)	Turning Prop.	Sat Flow (PCU/Hr)	Flared Sat Flow (PCU/Hr)
1/1 (A1077 E)	4.50	0.00	Y	Arm 5 Ahead Arm 9 Left	Inf 19.70	99.1 % 0.9 %	2064	2064
2/1 (A1077 W)	4.50	0.00	Y	Arm 8 Left	23.50	100.0 %	1941	1941
2/2 (A1077 W)	4.30	0.00	Y	Arm 10 Ahead	Inf	100.0 %	2045	2045
3/1 (B1216 N)	3.60	0.00	Y	Arm 10 Left	24.00	100.0 %	1859	1859
3/2 (B1216 N)	3.60	0.00	Y	Arm 7 Right	27.50	100.0 %	1873	1873
4/1 (Ferry Road West)	3.70	0.00	Y	Arm 5 Left Arm 6 Right	19.70 22.00	96.3 % 3.7 %	1845	1845
5/1 (Middle of junction WB)	3.95	0.00	Y	Arm 7 Ahead	Inf	100.0 %	2010	2010
5/2 (Middle of junction WB)	3.95	0.00	Y	Arm 8 Right	15.40	100.0 %	1832	1832
6/1 (A1077 E Exit Lane 1)	Infinite Saturation Flow						Inf	Inf
7/1 (A1077 W Exit Lane 1)	Infinite Saturation Flow						Inf	Inf
8/1 (B1216 Exit Lane 1)	Infinite Saturation Flow						Inf	Inf
9/1 (Ferry Road West Exit Lane 1)	Infinite Saturation Flow						Inf	Inf
10/1 (Middle of junction EB)	3.60	0.00	Y	Arm 6 Ahead	Inf	100.0 %	1975	1975
10/2 (Middle of junction EB)	3.60	0.00	Y	Arm 9 Right	18.00	100.0 %	1823	1823

Scenario 1: '7' (FG3: '2033 + CD (30% of Lincolnshire Lakes) + ERF AM', Plan 1: 'Network Control Plan 1')

Stage Sequence Diagram

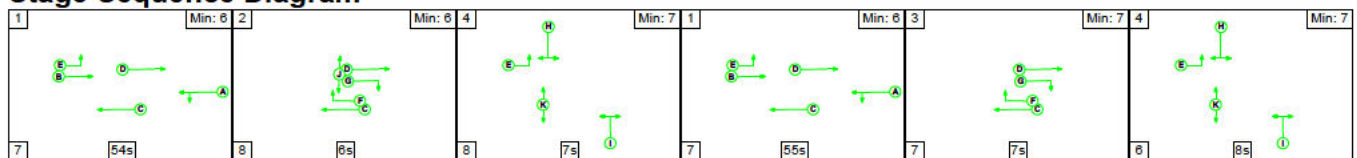

Stage Timings

Stage	1	2	4	1	3	4
Duration	54	6	7	55	7	8
Change Point	0	61	75	90	152	166

Full Input Data And Results Network Layout Diagram

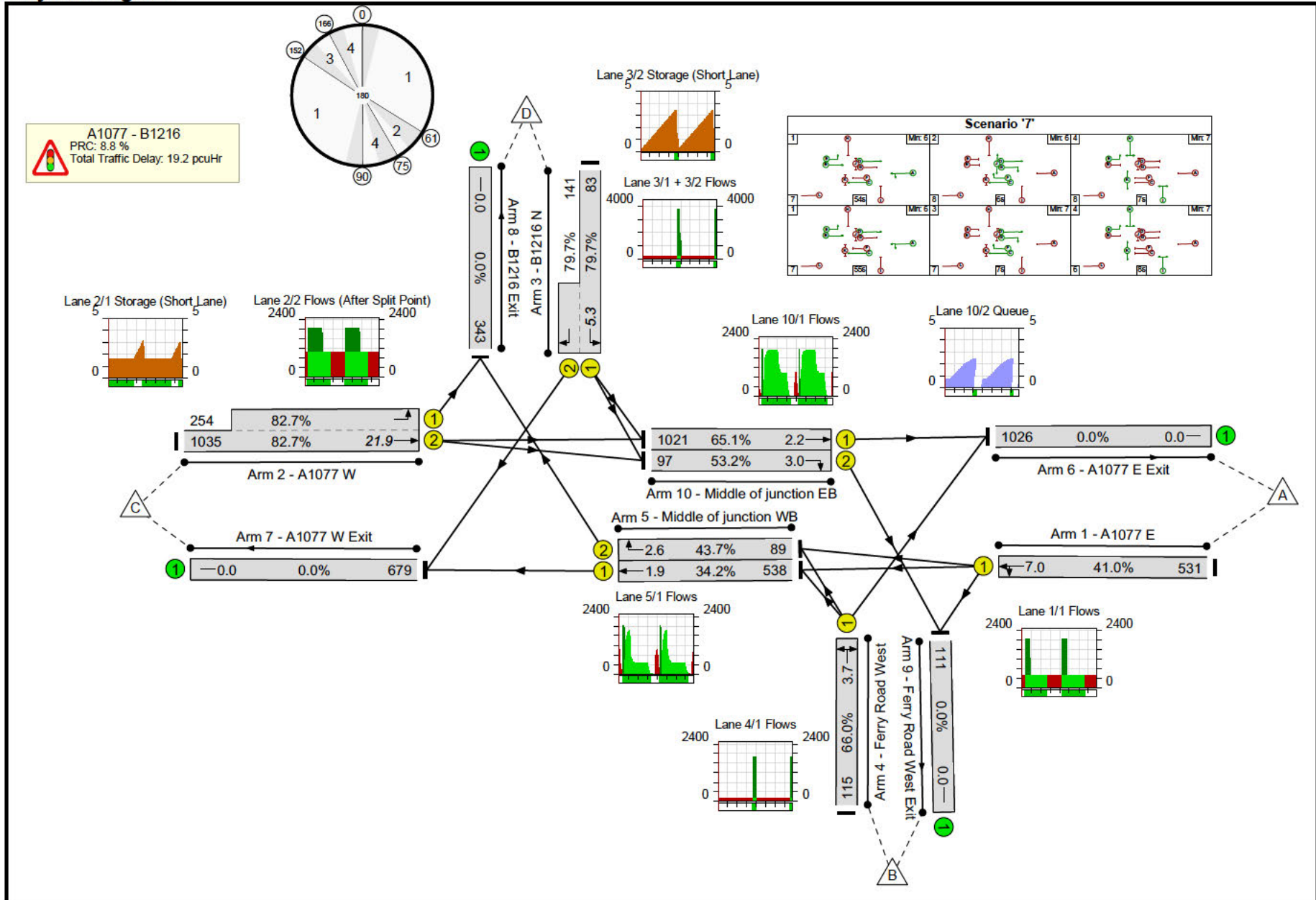

Full Input Data And Results

Network Results

Item	Lane Description	Lane Type	Controller Stream	Position In Filtered Route	Full Phase	Arrow Phase	Num Greens	Total Green (s)	Arrow Green (s)	Demand Flow (pcu)	Sat Flow (pcu/Hr)	Capacity (pcu)	Deg Sat (%)
Network: A1077 + B1216 junction	-	-	N/A	-	-		-	-	-	-	-	-	82.7%
A1077 - B1216	-	-	N/A	-	-		-	-	-	-	-	-	82.7%
1/1	A1077 E Ahead Left	U	N/A	N/A	A		2	111	-	531	2061	1294	41.0%
2/2+2/1	A1077 W Left Ahead	U	N/A	N/A	B E		2	111:138	-	1289	2045:1941	1252+307	82.7 : 82.7%
3/1+3/2	B1216 N Right Left	U	N/A	N/A	H		2	15	-	224	1859:1873	104+177	79.7 : 79.7%
4/1	Ferry Road West Left Right	U	N/A	N/A	I		2	15	-	115	1845	174	66.0%
5/1	Middle of junction WB Ahead	U	N/A	N/A	C		2	139	-	538	2010	1574	34.2%
5/2	Middle of junction WB Right	U	N/A	N/A	F		2	18	-	89	1832	204	43.7%
6/1	A1077 E Exit	U	N/A	N/A	-		-	-	-	1026	Inf	Inf	0.0%
7/1	A1077 W Exit	U	N/A	N/A	-		-	-	-	679	Inf	Inf	0.0%
8/1	B1216 Exit	U	N/A	N/A	-		-	-	-	343	Inf	Inf	0.0%
9/1	Ferry Road West Exit	U	N/A	N/A	-		-	-	-	111	Inf	Inf	0.0%
10/1	Middle of junction EB Ahead	U	N/A	N/A	D		2	141	-	1021	1975	1569	65.1%
10/2	Middle of junction EB Right	U	N/A	N/A	G		2	16	-	97	1823	182	53.2%

Full Input Data And Results

Item	Arriving (pcu)	Leaving (pcu)	Turners In Gaps (pcu)	Turners When Unopposed (pcu)	Turners In Intergreen (pcu)	Uniform Delay (pcuHr)	Rand + Oversat Delay (pcuHr)	Storage Area Uniform Delay (pcuHr)	Total Delay (pcuHr)	Av. Delay Per PCU (s/pcu)	Max. Back of Uniform Queue (pcu)	Rand + Oversat Queue (pcu)	Mean Max Queue (pcu)
Network: A1077 + B1216 junction	-	-	0	0	0	11.6	7.6	0.0	19.2	-	-	-	-
A1077 - B1216	-	-	0	0	0	11.6	7.6	0.0	19.2	-	-	-	-
1/1	531	531	-	-	-	1.2	0.3	-	1.6	10.8	6.6	0.3	7.0
2/2+2/1	1289	1289	-	-	-	3.8	2.3	-	6.2	17.2	19.6	2.3	21.9
3/1+3/2	224	224	-	-	-	2.5	1.8	-	4.3	69.1	3.4	1.8	5.3
4/1	115	115	-	-	-	1.3	0.9	-	2.2	68.8	2.8	0.9	3.7
5/1	538	538	-	-	-	0.2	0.3	-	0.4	2.9	1.7	0.3	1.9
5/2	89	89	-	-	-	1.3	0.4	-	1.7	68.5	2.2	0.4	2.6
6/1	1026	1026	-	-	-	0.0	0.0	-	0.0	0.0	0.0	0.0	0.0
7/1	679	679	-	-	-	0.0	0.0	-	0.0	0.0	0.0	0.0	0.0
8/1	343	343	-	-	-	0.0	0.0	-	0.0	0.0	0.0	0.0	0.0
9/1	111	111	-	-	-	0.0	0.0	-	0.0	0.0	0.0	0.0	0.0
10/1	1021	1021	-	-	-	0.1	0.9	-	1.1	3.7	1.3	0.9	2.2
10/2	97	97	-	-	-	1.2	0.6	-	1.8	67.1	2.4	0.6	3.0
C1			PRC for Signalled Lanes (%):		8.8	Total Delay for Signalled Lanes (pcuHr):		19.22	Cycle Time (s): 180				
			PRC Over All Lanes (%):		8.8	Total Delay Over All Lanes(pcuHr):		19.22					

Full Input Data And Results

Scenario 2: '8' (FG4: '2033 + CD (30% of Lincolnshire Lakes) + ERF PM', Plan 1: 'Network Control Plan 1')

Stage Sequence Diagram

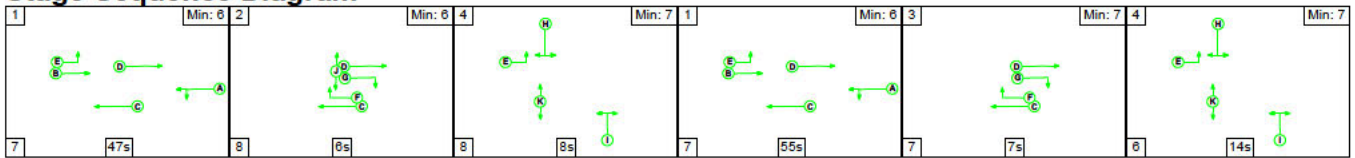

Stage Timings

Stage	1	2	4	1	3	4
Duration	47	6	8	55	7	14
Change Point	0	54	68	84	146	160

Signal Timings Diagram

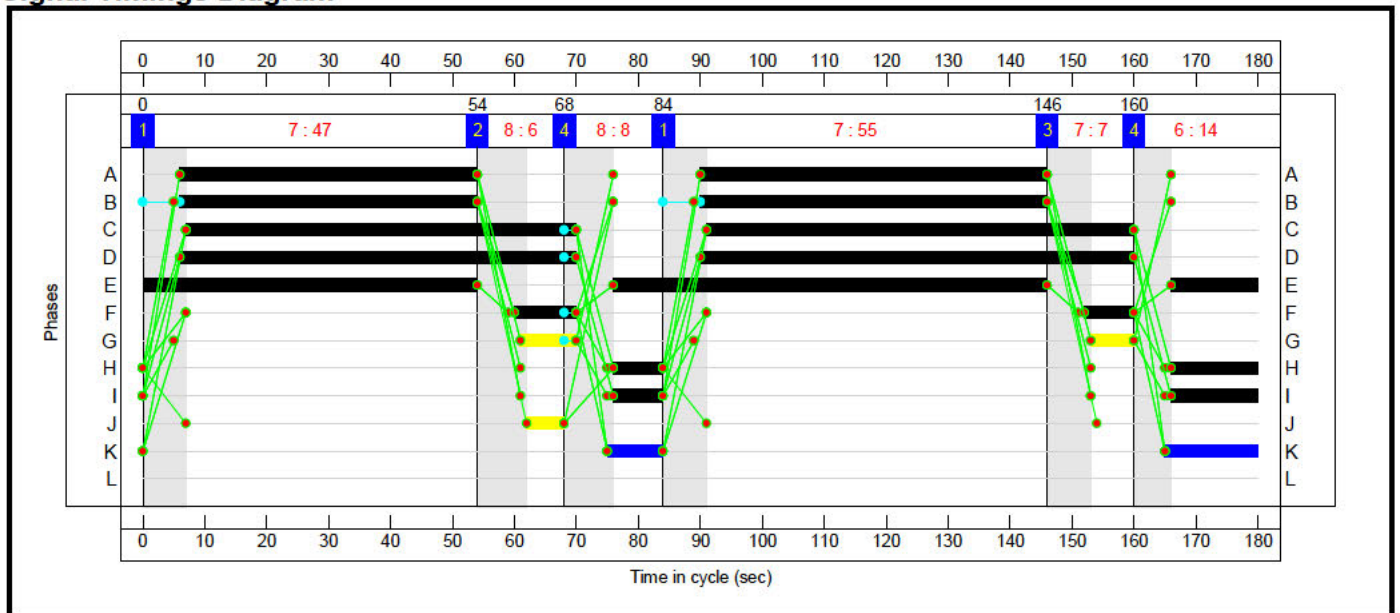

Full Input Data And Results Network Layout Diagram

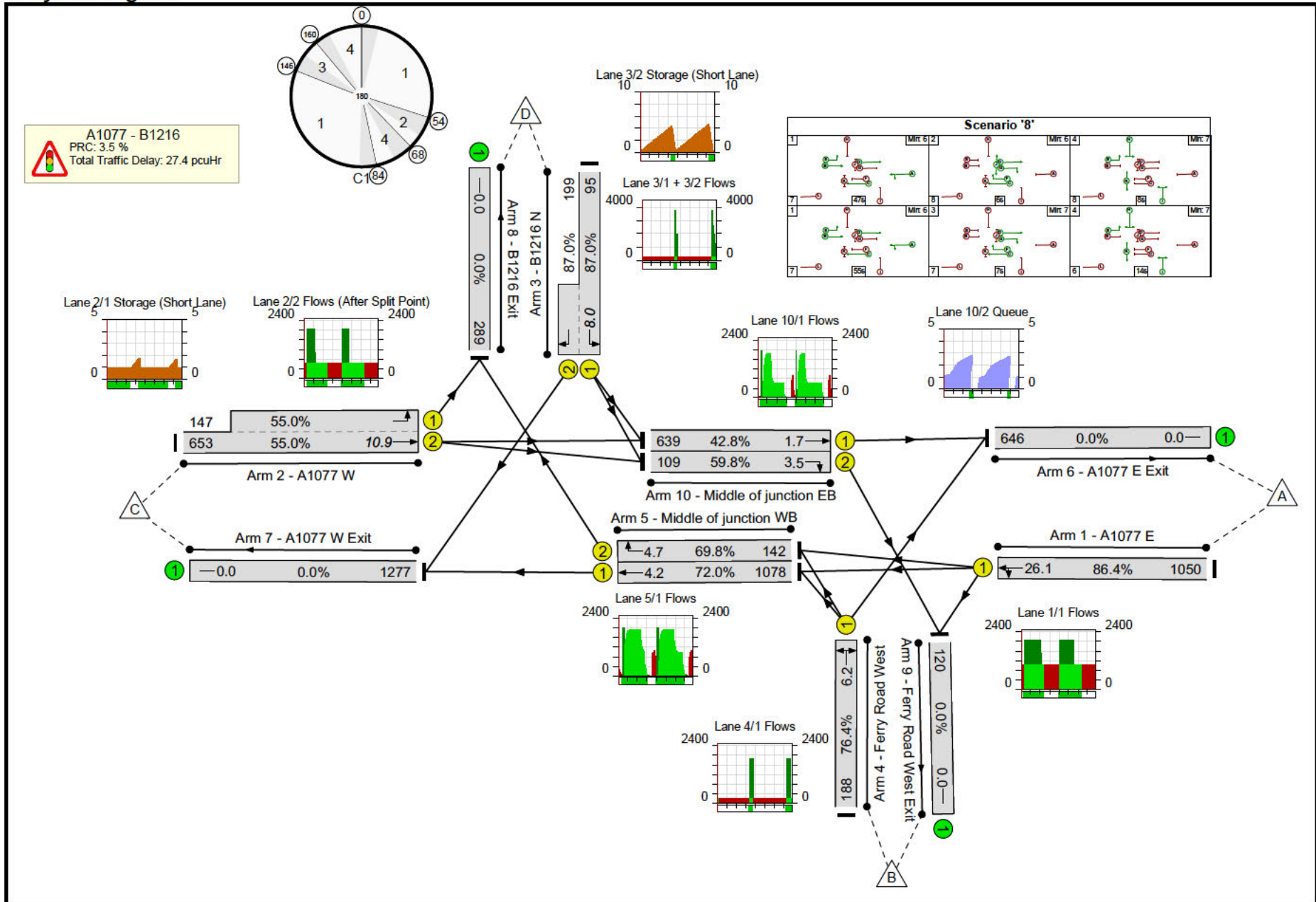

Full Input Data And Results

Network Results

Item	Lane Description	Lane Type	Controller Stream	Position In Filtered Route	Full Phase	Arrow Phase	Num Greens	Total Green (s)	Arrow Green (s)	Demand Flow (pcu)	Sat Flow (pcu/Hr)	Capacity (pcu)	Deg Sat (%)
Network: A1077 + B1216 junction	-	-	N/A	-	-		-	-	-	-	-	-	87.0%
A1077 - B1216	-	-	N/A	-	-		-	-	-	-	-	-	87.0%
1/1	A1077 E Ahead Left	U	N/A	N/A	A		2	104	-	1050	2063	1215	86.4%
2/2+2/1	A1077 W Left Ahead	U	N/A	N/A	B E		2	104:138	-	800	2045:1941	1188+268	55.0 : 55.0%
3/1+3/2	B1216 N Right Left	U	N/A	N/A	H		2	22	-	294	1859:1873	109+229	87.0 : 87.0%
4/1	Ferry Road West Left Right	U	N/A	N/A	I		2	22	-	188	1845	246	76.4%
5/1	Middle of junction WB Ahead	U	N/A	N/A	C		2	132	-	1078	2010	1496	72.0%
5/2	Middle of junction WB Right	U	N/A	N/A	F		2	18	-	142	1832	204	69.8%
6/1	A1077 E Exit	U	N/A	N/A	-		-	-	-	646	Inf	Inf	0.0%
7/1	A1077 W Exit	U	N/A	N/A	-		-	-	-	1277	Inf	Inf	0.0%
8/1	B1216 Exit	U	N/A	N/A	-		-	-	-	289	Inf	Inf	0.0%
9/1	Ferry Road West Exit	U	N/A	N/A	-		-	-	-	120	Inf	Inf	0.0%
10/1	Middle of junction EB Ahead	U	N/A	N/A	D		2	134	-	639	1975	1492	42.8%
10/2	Middle of junction EB Right	U	N/A	N/A	G		2	16	-	109	1823	182	59.8%

Full Input Data And Results

Item	Arriving (pcu)	Leaving (pcu)	Turners In Gaps (pcu)	Turners When Unopposed (pcu)	Turners In Intergreen (pcu)	Uniform Delay (pcuHr)	Rand + Oversat Delay (pcuHr)	Storage Area Uniform Delay (pcuHr)	Total Delay (pcuHr)	Av. Delay Per PCU (s/pcu)	Max. Back of Uniform Queue (pcu)	Rand + Oversat Queue (pcu)	Mean Max Queue (pcu)
Network: A1077 + B1216 junction	-	-	0	0	0	15.7	11.7	0.0	27.4	-	-	-	-
A1077 - B1216	-	-	0	0	0	15.7	11.7	0.0	27.4	-	-	-	-
1/1	1050	1050	-	-	-	4.5	3.1	-	7.6	26.1	23.0	3.1	26.1
2/2+2/1	800	800	-	-	-	2.1	0.6	-	2.7	12.3	10.3	0.6	10.9
3/1+3/2	294	294	-	-	-	3.0	2.9	-	6.0	73.3	5.1	2.9	8.0
4/1	188	188	-	-	-	2.0	1.5	-	3.5	67.2	4.7	1.5	6.2
5/1	1078	1078	-	-	-	0.4	1.3	-	1.6	5.5	2.9	1.3	4.2
5/2	142	142	-	-	-	2.0	1.1	-	3.1	78.9	3.6	1.1	4.7
6/1	646	646	-	-	-	0.0	0.0	-	0.0	0.0	0.0	0.0	0.0
7/1	1277	1277	-	-	-	0.0	0.0	-	0.0	0.0	0.0	0.0	0.0
8/1	289	289	-	-	-	0.0	0.0	-	0.0	0.0	0.0	0.0	0.0
9/1	120	120	-	-	-	0.0	0.0	-	0.0	0.0	0.0	0.0	0.0
10/1	639	639	-	-	-	0.2	0.4	-	0.5	3.0	1.4	0.4	1.7
10/2	109	109	-	-	-	1.5	0.7	-	2.3	74.5	2.8	0.7	3.5
C1			PRC for Signalled Lanes (%):		3.5	Total Delay for Signalled Lanes (pcuHr):		27.38	Cycle Time (s):		180		
			PRC Over All Lanes (%):		3.5	Total Delay Over All Lanes(pcuHr):		27.38					

Full Input Data And Results

Scenario 3: '9' (FG5: '2038 + CD (50% of Lincolnshire Lakes) + ERF AM', Plan 1: 'Network Control Plan 1')

Stage Sequence Diagram

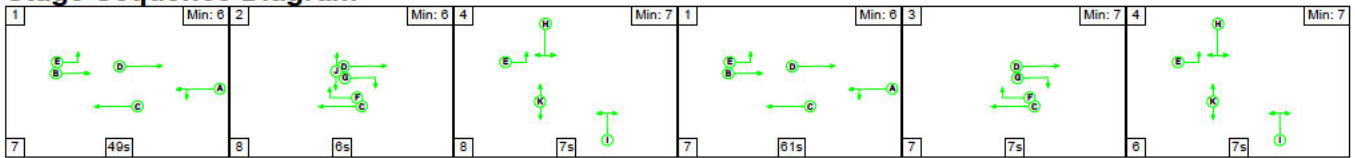

Stage Timings

Stage	1	2	4	1	3	4
Duration	49	6	7	61	7	7
Change Point	0	56	70	85	153	167

Signal Timings Diagram

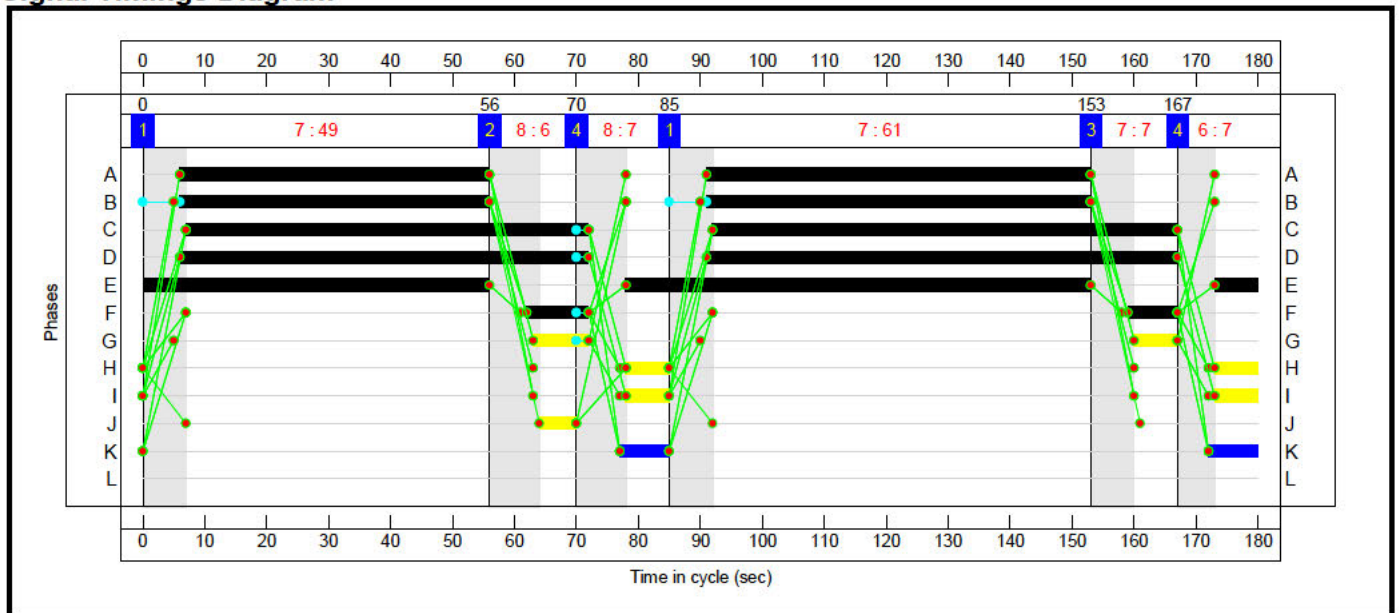

Full Input Data And Results Network Layout Diagram

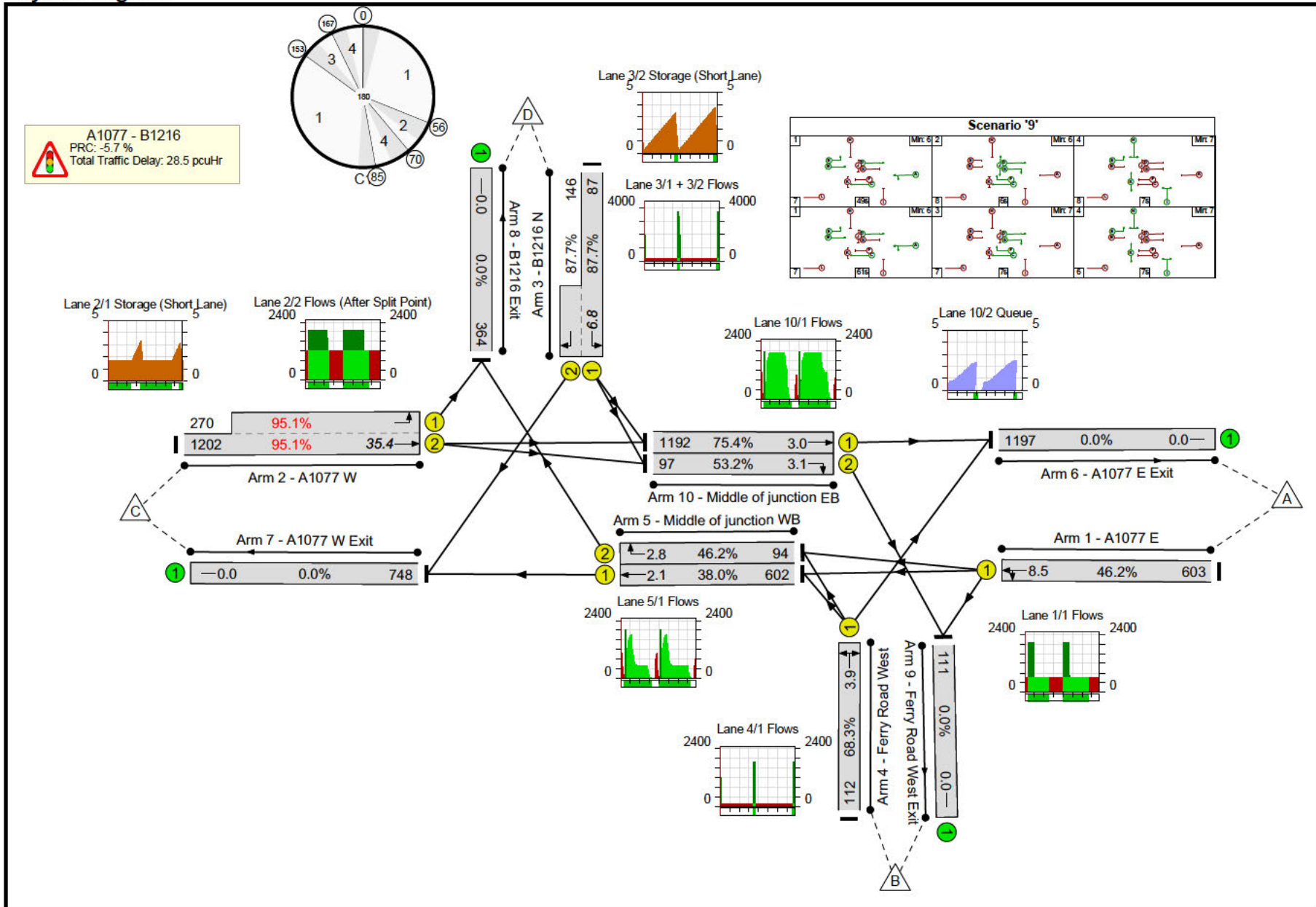

Full Input Data And Results

Network Results

Item	Lane Description	Lane Type	Controller Stream	Position In Filtered Route	Full Phase	Arrow Phase	Num Greens	Total Green (s)	Arrow Green (s)	Demand Flow (pcu)	Sat Flow (pcu/Hr)	Capacity (pcu)	Deg Sat (%)
Network: A1077 + B1216 junction	-	-	N/A	-	-		-	-	-	-	-	-	95.1%
A1077 - B1216	-	-	N/A	-	-		-	-	-	-	-	-	95.1%
1/1	A1077 E Ahead Left	U	N/A	N/A	A		2	112	-	603	2061	1305	46.2%
2/2+2/1	A1077 W Left Ahead	U	N/A	N/A	B E		2	112:138	-	1472	2045:1941	1264+284	95.1% 95.1%
3/1+3/2	B1216 N Right Left	U	N/A	N/A	H		2	14	-	233	1859:1873	99+166	87.7% 87.7%
4/1	Ferry Road West Left Right	U	N/A	N/A	I		2	14	-	112	1845	164	68.3%
5/1	Middle of junction WB Ahead	U	N/A	N/A	C		2	140	-	602	2010	1586	38.0%
5/2	Middle of junction WB Right	U	N/A	N/A	F		2	18	-	94	1832	204	46.2%
6/1	A1077 E Exit	U	N/A	N/A	-		-	-	-	1197	Inf	Inf	0.0%
7/1	A1077 W Exit	U	N/A	N/A	-		-	-	-	748	Inf	Inf	0.0%
8/1	B1216 Exit	U	N/A	N/A	-		-	-	-	364	Inf	Inf	0.0%
9/1	Ferry Road West Exit	U	N/A	N/A	-		-	-	-	111	Inf	Inf	0.0%
10/1	Middle of junction EB Ahead	U	N/A	N/A	D		2	142	-	1192	1975	1580	75.4%
10/2	Middle of junction EB Right	U	N/A	N/A	G		2	16	-	97	1823	182	53.2%

Full Input Data And Results

Item	Arriving (pcu)	Leaving (pcu)	Turners In Gaps (pcu)	Turners When Unopposed (pcu)	Turners In Intergreen (pcu)	Uniform Delay (pcuHr)	Rand + Oversat Delay (pcuHr)	Storage Area Uniform Delay (pcuHr)	Total Delay (pcuHr)	Av. Delay Per PCU (s/pcu)	Max. Back of Uniform Queue (pcu)	Rand + Oversat Queue (pcu)	Mean Max Queue (pcu)
Network: A1077 + B1216 junction	-	-	0	0	0	13.2	15.3	0.0	28.5	-	-	-	-
A1077 - B1216	-	-	0	0	0	13.2	15.3	0.0	28.5	-	-	-	-
1/1	603	603	-	-	-	1.4	0.4	-	1.9	11.1	8.0	0.4	8.5
2/2+2/1	1472	1472	-	-	-	5.1	8.0	-	13.1	32.0	27.4	8.0	35.4
3/1+3/2	233	233	-	-	-	2.6	3.0	-	5.6	86.7	3.8	3.0	6.8
4/1	112	112	-	-	-	1.2	1.0	-	2.3	73.2	2.9	1.0	3.9
5/1	602	602	-	-	-	0.2	0.3	-	0.5	2.8	1.8	0.3	2.1
5/2	94	94	-	-	-	1.3	0.4	-	1.8	67.2	2.4	0.4	2.8
6/1	1197	1197	-	-	-	0.0	0.0	-	0.0	0.0	0.0	0.0	0.0
7/1	748	748	-	-	-	0.0	0.0	-	0.0	0.0	0.0	0.0	0.0
8/1	364	364	-	-	-	0.0	0.0	-	0.0	0.0	0.0	0.0	0.0
9/1	111	111	-	-	-	0.0	0.0	-	0.0	0.0	0.0	0.0	0.0
10/1	1192	1192	-	-	-	0.1	1.5	-	1.7	5.0	1.5	1.5	3.0
10/2	97	97	-	-	-	1.2	0.6	-	1.8	65.7	2.5	0.6	3.1
C1			PRC for Signalled Lanes (%):		-5.7	Total Delay for Signalled Lanes (pcuHr):			28.50	Cycle Time (s): 180			
			PRC Over All Lanes (%):		-5.7	Total Delay Over All Lanes(pcuHr):			28.50				

Full Input Data And Results

Scenario 4: '10' (FG6: '2039 + CD (50% of Lincolnshire Lakes) + ERF PM', Plan 1: 'Network Control Plan 1')

Stage Sequence Diagram

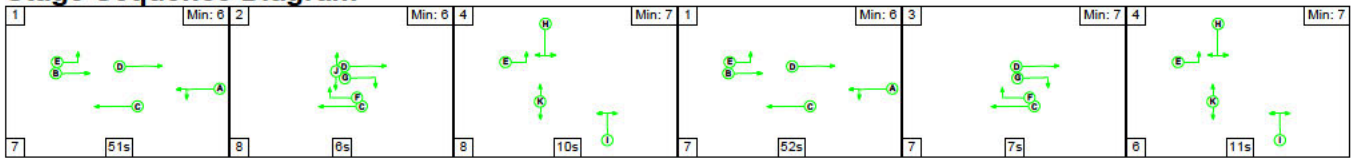

Stage Timings

Stage	1	2	4	1	3	4
Duration	51	6	10	52	7	11
Change Point	0	58	72	90	149	163

Signal Timings Diagram

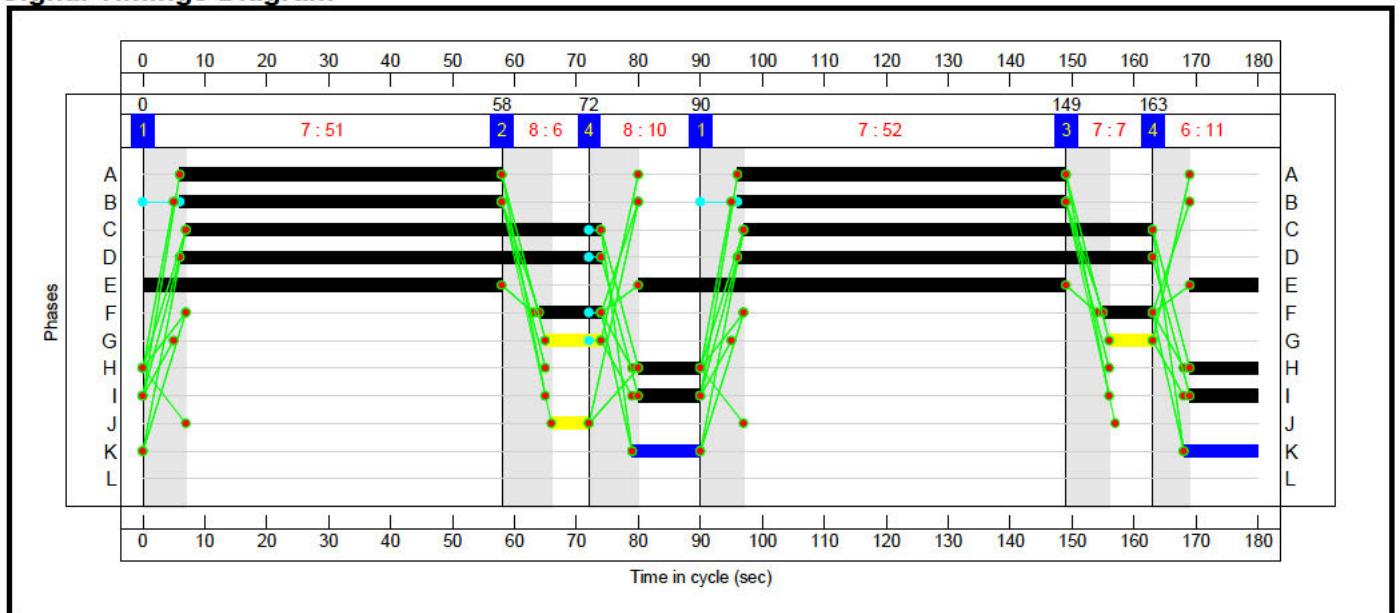

Full Input Data And Results Network Layout Diagram

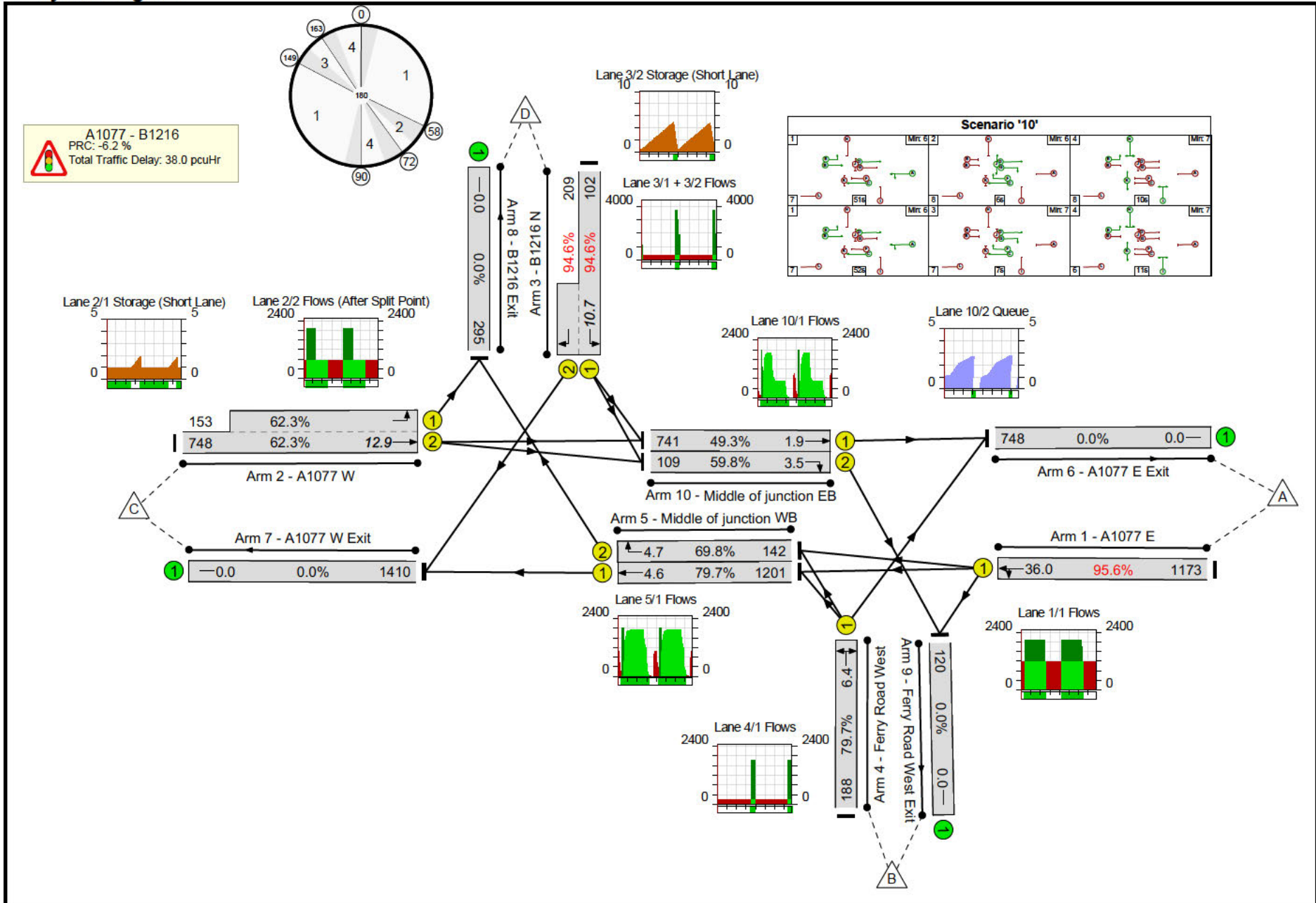

Full Input Data And Results

Network Results

Item	Lane Description	Lane Type	Controller Stream	Position In Filtered Route	Full Phase	Arrow Phase	Num Greens	Total Green (s)	Arrow Green (s)	Demand Flow (pcu)	Sat Flow (pcu/Hr)	Capacity (pcu)	Deg Sat (%)
Network: A1077 + B1216 junction	-	-	N/A	-	-		-	-	-	-	-	-	95.6%
A1077 - B1216	-	-	N/A	-	-		-	-	-	-	-	-	95.6%
1/1	A1077 E Ahead Left	U	N/A	N/A	A		2	105	-	1173	2064	1227	95.6%
2/2+2/1	A1077 W Left Ahead	U	N/A	N/A	B E		2	105:138	-	901	2045:1941	1200+246	62.3 : 62.3%
3/1+3/2	B1216 N Right Left	U	N/A	N/A	H		2	21	-	311	1859:1873	108+221	94.6 : 94.6%
4/1	Ferry Road West Left Right	U	N/A	N/A	I		2	21	-	188	1845	236	79.7%
5/1	Middle of junction WB Ahead	U	N/A	N/A	C		2	133	-	1201	2010	1508	79.7%
5/2	Middle of junction WB Right	U	N/A	N/A	F		2	18	-	142	1832	204	69.8%
6/1	A1077 E Exit	U	N/A	N/A	-		-	-	-	748	Inf	Inf	0.0%
7/1	A1077 W Exit	U	N/A	N/A	-		-	-	-	1410	Inf	Inf	0.0%
8/1	B1216 Exit	U	N/A	N/A	-		-	-	-	295	Inf	Inf	0.0%
9/1	Ferry Road West Exit	U	N/A	N/A	-		-	-	-	120	Inf	Inf	0.0%
10/1	Middle of junction EB Ahead	U	N/A	N/A	D		2	135	-	741	1975	1503	49.3%
10/2	Middle of junction EB Right	U	N/A	N/A	G		2	16	-	109	1823	182	59.8%

Full Input Data And Results

Item	Arriving (pcu)	Leaving (pcu)	Turners In Gaps (pcu)	Turners When Unopposed (pcu)	Turners In Intergreen (pcu)	Uniform Delay (pcuHr)	Rand + Oversat Delay (pcuHr)	Storage Area Uniform Delay (pcuHr)	Total Delay (pcuHr)	Av. Delay Per PCU (s/pcu)	Max. Back of Uniform Queue (pcu)	Rand + Oversat Queue (pcu)	Mean Max Queue (pcu)
Network: A1077 + B1216 junction	-	-	0	0	0	17.4	20.7	0.0	38.0	-	-	-	-
A1077 - B1216	-	-	0	0	0	17.4	20.7	0.0	38.0	-	-	-	-
1/1	1173	1173	-	-	-	5.6	8.3	-	13.9	42.7	27.7	8.3	36.0
2/2+2/1	901	901	-	-	-	2.5	0.8	-	3.4	13.4	12.1	0.8	12.9
3/1+3/2	311	311	-	-	-	3.3	5.4	-	8.7	100.7	5.3	5.4	10.7
4/1	188	188	-	-	-	2.0	1.8	-	3.8	73.1	4.5	1.8	6.4
5/1	1201	1201	-	-	-	0.3	1.9	-	2.3	6.8	2.7	1.9	4.6
5/2	142	142	-	-	-	2.0	1.1	-	3.1	78.2	3.6	1.1	4.7
6/1	748	748	-	-	-	0.0	0.0	-	0.0	0.0	0.0	0.0	0.0
7/1	1410	1410	-	-	-	0.0	0.0	-	0.0	0.0	0.0	0.0	0.0
8/1	295	295	-	-	-	0.0	0.0	-	0.0	0.0	0.0	0.0	0.0
9/1	120	120	-	-	-	0.0	0.0	-	0.0	0.0	0.0	0.0	0.0
10/1	741	741	-	-	-	0.2	0.5	-	0.7	3.2	1.5	0.5	1.9
10/2	109	109	-	-	-	1.5	0.7	-	2.2	74.1	2.7	0.7	3.5
C1			PRC for Signalled Lanes (%):		-6.2	Total Delay for Signalled Lanes (pcuHr):			38.04	Cycle Time (s): 180			
			PRC Over All Lanes (%):		-6.2	Total Delay Over All Lanes(pcuHr):			38.04				

Appendix J PICADY Results - Stather Road / New Access Road Priority Junction

<h1>Junctions 9</h1>
PICADY 9 - Priority Intersection Module
Version: 9.5.0.6896 © Copyright TRL Limited, 2018
For sales and distribution information, program advice and maintenance, contact TRL: +44 (0)1344 379777 software@trl.co.uk
The users of this computer program for the solution of an engineering problem are in no way relieved of their responsibility for the correctness of the solution

Filename: North Lincs Energy Park - Stather Road New Access Road_Direct Input.j9
Path: C:\Users\vlomas\BuroHappold\046658 North Lincs Green Energy Park - 33_Transport Engineering\01 Assessments\Junction Assessments\PICADY\Stather Road Site Access Junction
Report generation date: 14/01/2022 11:28:40

- »2022 Observed Traffic Flows, AM
- »2022 Observed Traffic Flows, PM
- »2028 + Committed Development No Development Traffic, AM
- »2028 + Committed Development No Development Traffic, PM
- »2028 + Committed Development + Development Traffic, AM
- »2028 + Committed Development + Development Traffic, PM
- »2038 + Committed Development + Development (Sensitivity Test), AM
- »2038 + Committed Development + Development (Sensitivity Test), PM

Summary of junction performance

	AM				PM			
	Queue (PCU)	Delay (s)	RFC	Junction Delay (s)	Queue (PCU)	Delay (s)	RFC	Junction Delay (s)
2022 Observed Traffic Flows								
Stream B-AC	0.1	5.59	0.11	4.85	0.1	5.90	0.11	4.83
Stream C-B	0.0	5.75	0.04		0.1	5.60	0.06	
2028 + Committed Development No Development Traffic								
Stream B-AC	0.1	5.61	0.11	4.89	0.1	5.95	0.11	4.86
Stream C-B	0.0	5.89	0.04		0.1	5.70	0.06	
2028 + Committed Development + Development Traffic								
Stream B-AC	0.1	5.63	0.11	4.93	0.1	5.95	0.11	4.86
Stream C-B	0.0	5.89	0.04		0.1	5.70	0.06	
2038 + Committed Development + Development (Sensitivity Test)								
Stream B-AC	0.1	5.68	0.13	5.02	0.1	5.97	0.12	4.79
Stream C-B	0.1	5.84	0.05		0.1	5.70	0.06	

Values shown are the highest values encountered over all time segments. Delay is the maximum value of average delay per arriving vehicle. Junction LOS and Junction Delay are demand-weighted averages.

File summary

File Description

Title	Stather Road / New Access Road - North Lincolnshire Green Energy Park
Location	Flixborough, Scunthorpe
Site number	
Date	07/01/2021
Version	
Status	(new file)
Identifier	
Client	
Jobnumber	
Enumerator	BUROHAPPOLD\vlomas
Description	

Units

Distance units	Speed units	Traffic units input	Traffic units results	Flow units	Average delay units	Total delay units	Rate of delay units
m	kph	PCU	PCU	perHour	s	-Min	perMin

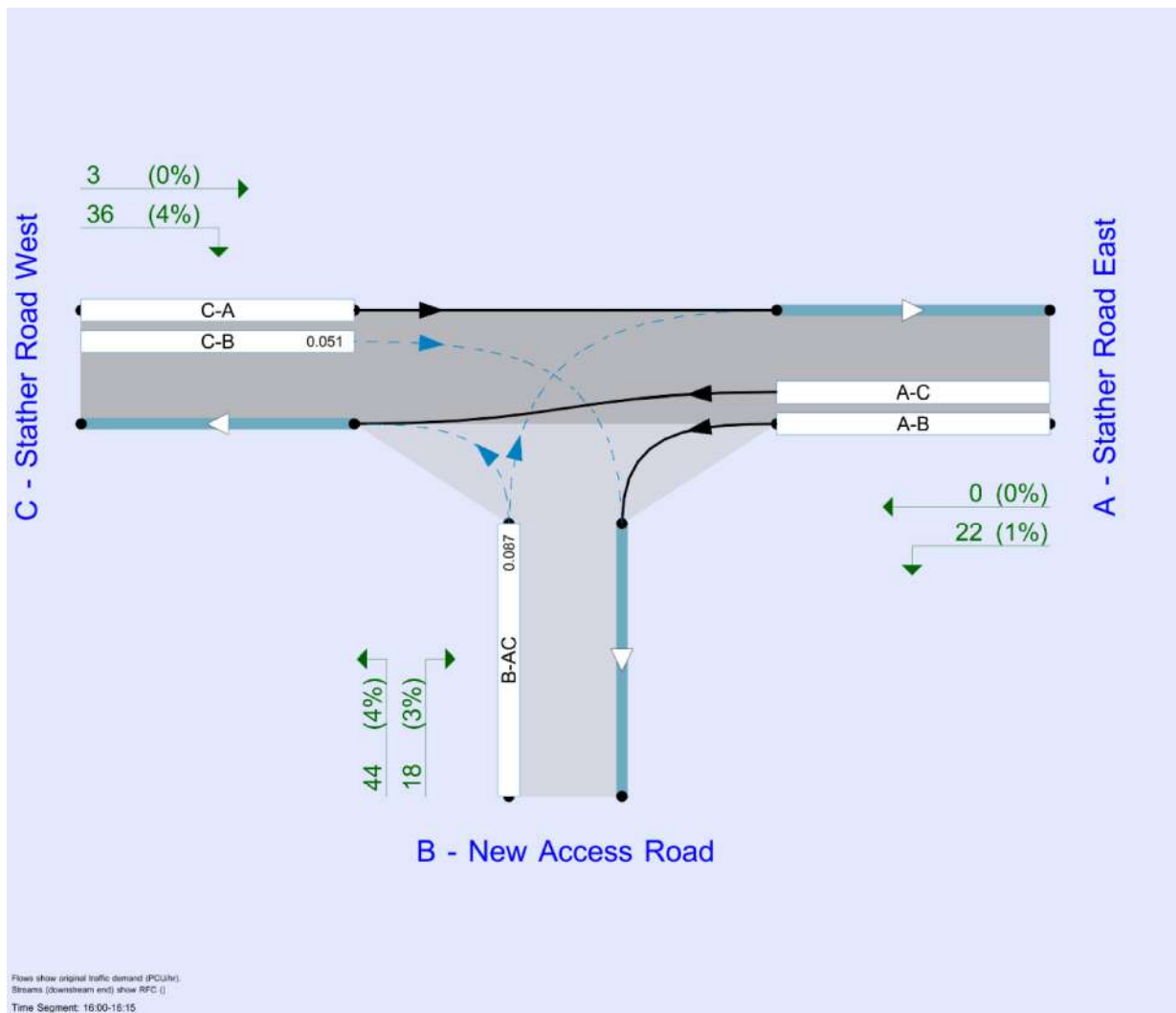

Analysis Options

Vehicle length (m)	Calculate Queue Percentiles	Calculate detailed queuing delay	Calculate residual capacity	RFC Threshold	Average Delay threshold (s)	Queue threshold (PCU)
5.75				0.85	36.00	20.00

Demand Set Summary

ID	Scenario name	Time Period name	Traffic profile type	Start time (HH:mm)	Finish time (HH:mm)	Time period length (min)	Time segment length (min)	Run automatically
D1	2022 Observed Traffic Flows	AM	DIRECT	08:00	09:00	60	15	✓
D2	2022 Observed Traffic Flows	PM	DIRECT	16:00	17:00	60	15	✓
D3	2028 + Committed Development No Development Traffic	AM	DIRECT	08:00	09:00	60	15	✓
D4	2028 + Committed Development No Development Traffic	PM	DIRECT	16:00	17:00	60	15	✓
D5	2028 + Committed Development + Development Traffic	AM	DIRECT	08:00	09:00	60	15	✓
D6	2028 + Committed Development + Development Traffic	PM	DIRECT	16:00	17:00	60	15	✓
D8	2038 + Committed Development + Development (Sensitivity Test)	AM	DIRECT	08:00	09:00	60	15	✓
D9	2038 + Committed Development + Development (Sensitivity Test)	PM	DIRECT	16:00	17:00	60	15	✓

Analysis Set Details

ID	Include in report	Network flow scaling factor (%)	Network capacity scaling factor (%)
A1	✓	100.000	100.000

2022 Observed Traffic Flows, AM

Data Errors and Warnings

No errors or warnings

Junction Network

Junctions

Junction	Name	Junction type	Major road direction	Use circulating lanes	Junction Delay (s)	Junction LOS
1	untitled	T-Junction	Two-way		4.85	A

Junction Network Options

Driving side	Lighting
Left	Normal/unknown

Arms

Arms

Arm	Name	Description	Arm type
A	Stather Road East		Major
B	New Access Road		Minor
C	Stather Road West		Major

Major Arm Geometry

Arm	Width of carriageway (m)	Has kerbed central reserve	Has right turn bay	Width for right turn (m)	Visibility for right turn (m)	Blocks?	Blocking queue (PCU)
C - Stather Road West	7.50		✓	3.50	80.0		-

Geometries for Arm C are measured opposite Arm B. Geometries for Arm A (if relevant) are measured opposite Arm D.

Minor Arm Geometry

Arm	Minor arm type	Lane width (m)	Visibility to left (m)	Visibility to right (m)
B - New Access Road	One lane	3.25	100	200

Slope / Intercept / Capacity

Priority Intersection Slopes and Intercepts

Junction	Stream	Intercept (PCU/hr)	Slope for A-B	Slope for A-C	Slope for C-A	Slope for C-B
1	B-A	627	0.107	0.270	0.170	0.386
1	B-C	769	0.110	0.278	-	-
1	C-B	708	0.256	0.256	-	-

The slopes and intercepts shown above do NOT include any corrections or adjustments.

Streams may be combined, in which case capacity will be adjusted.

Values are shown for the first time segment only; they may differ for subsequent time segments.

Traffic Demand

Demand Set Details

ID	Scenario name	Time Period name	Traffic profile type	Start time (HH:mm)	Finish time (HH:mm)	Time period length (min)	Time segment length (min)	Run automatically
D1	2022 Observed Traffic Flows	AM	DIRECT	08:00	09:00	60	15	✓

Vehicle mix varies over time	Vehicle mix varies over turn	Vehicle mix varies over entry	Vehicle mix source	PCU Factor for a HV (PCU)	O-D data varies over time
✓	✓	✓	HV Percentages	2.00	✓

Demand overview (Traffic)

Arm	Linked arm	Profile type	Use O-D data	Scaling Factor (%)
A - Stather Road East		DIRECT	✓	100.000

B - New Access Road		DIRECT	✓	100.000
C - Stather Road West		DIRECT	✓	100.000

Origin-Destination Data

Demand (PCU/hr)

		To			
		A - Stather Road East	B - New Access Road	C - Stather Road West	
08:00 - 08:15	From	A - Stather Road East	0	10	1
		B - New Access Road	8	0	51
		C - Stather Road West	0	19	0

Demand (PCU/hr)

		To			
		A - Stather Road East	B - New Access Road	C - Stather Road West	
08:15 - 08:30	From	A - Stather Road East	0	17	1
		B - New Access Road	9	0	58
		C - Stather Road West	0	29	0

Demand (PCU/hr)

		To			
		A - Stather Road East	B - New Access Road	C - Stather Road West	
08:30 - 08:45	From	A - Stather Road East	0	9	1
		B - New Access Road	7	0	44
		C - Stather Road West	0	17	0

Demand (PCU/hr)

		To			
		A - Stather Road East	B - New Access Road	C - Stather Road West	
08:45 - 09:00	From	A - Stather Road East	0	15	1
		B - New Access Road	11	0	69
		C - Stather Road West	0	19	0

Vehicle Mix

Heavy Vehicle Percentages

		To			
		A - Stather Road East	B - New Access Road	C - Stather Road West	
08:00 - 08:15	From	A - Stather Road East	0	1	8
		B - New Access Road	2	0	3
		C - Stather Road West	0	6	0

Heavy Vehicle Percentages

		To			
		A - Stather Road East	B - New Access Road	C - Stather Road West	
08:15 - 08:30	From	A - Stather Road East	0	2	13
		B - New Access Road	2	0	3
		C - Stather Road West	0	9	0

Heavy Vehicle Percentages

		To			
		A - Stather Road East	B - New Access Road	C - Stather Road West	
08:30 - 08:45	From	A - Stather Road East	0	1	7
		B - New Access Road	1	0	2
		C - Stather Road West	2	5	0

Heavy Vehicle Percentages

		To			
		A - Stather Road East	B - New Access Road	C - Stather Road West	
08:45 - 09:00	From	A - Stather Road East	0	2	12
		B - New Access Road	2	0	4
		C - Stather Road West	2	6	0

Results

Results Summary for whole modelled period

Stream	Max RFC	Max Delay (s)	Max Queue (PCU)	Max LOS	Average Demand (PCU/hr)	Total Junction Arrivals (PCU)
B-AC	0.11	5.59	0.1	A	64	64

C-A					0	0
C-B	0.04	5.75	0.0	A	21	21
A-B					13	13
A-C					1	1

Main Results for each time segment

08:00 - 08:15

Stream	Total Demand (PCU/hr)	Junction Arrivals (PCU)	Capacity (PCU/hr)	RFC	Throughput (PCU/hr)	Start queue (PCU)	End queue (PCU)	Delay (s)	Unsignalised level of service
B-AC	59	15	743	0.079	59	0.0	0.1	5.408	A
C-A	0	0			0				
C-B	19	5	705	0.027	19	0.0	0.0	5.560	A
A-B	10	3			10				
A-C	1	0.25			1				

08:15 - 08:30

Stream	Total Demand (PCU/hr)	Junction Arrivals (PCU)	Capacity (PCU/hr)	RFC	Throughput (PCU/hr)	Start queue (PCU)	End queue (PCU)	Delay (s)	Unsignalised level of service
B-AC	67	17	742	0.090	67	0.1	0.1	5.487	A
C-A	0	0			0				
C-B	29	7	703	0.041	29	0.0	0.0	5.750	A
A-B	17	4			17				
A-C	1	0.25			1				

08:30 - 08:45

Stream	Total Demand (PCU/hr)	Junction Arrivals (PCU)	Capacity (PCU/hr)	RFC	Throughput (PCU/hr)	Start queue (PCU)	End queue (PCU)	Delay (s)	Unsignalised level of service
B-AC	51	13	743	0.069	51	0.1	0.1	5.331	A
C-A	0	0			0				
C-B	17	4	705	0.024	17	0.0	0.0	5.626	A
A-B	9	2			9				
A-C	1	0.25			1				

08:45 - 09:00

Stream	Total Demand (PCU/hr)	Junction Arrivals (PCU)	Capacity (PCU/hr)	RFC	Throughput (PCU/hr)	Start queue (PCU)	End queue (PCU)	Delay (s)	Unsignalised level of service
B-AC	80	20	742	0.108	80	0.1	0.1	5.591	A
C-A	0	0			0				
C-B	19	5	704	0.027	19	0.0	0.0	5.544	A
A-B	15	4			15				
A-C	1	0.25			1				

2022 Observed Traffic Flows, PM

Data Errors and Warnings

No errors or warnings

Junction Network

Junctions

Junction	Name	Junction type	Major road direction	Use circulating lanes	Junction Delay (s)	Junction LOS
1	untitled	T-Junction	Two-way		4.83	A

Junction Network Options

Driving side	Lighting
Left	Normal/unknown

Traffic Demand

Demand Set Details

ID	Scenario name	Time Period name	Traffic profile type	Start time (HH:mm)	Finish time (HH:mm)	Time period length (min)	Time segment length (min)	Run automatically
D2	2022 Observed Traffic Flows	PM	DIRECT	16:00	17:00	60	15	✓

Vehicle mix varies over time	Vehicle mix varies over turn	Vehicle mix varies over entry	Vehicle mix source	PCU Factor for a HV (PCU)	O-D data varies over time
✓	✓	✓	HV Percentages	2.00	✓

Demand overview (Traffic)

Arm	Linked arm	Profile type	Use O-D data	Scaling Factor (%)
A - Stather Road East		DIRECT	✓	100.000
B - New Access Road		DIRECT	✓	100.000
C - Stather Road West		DIRECT	✓	100.000

Origin-Destination Data

Demand (PCU/hr)

		To			
		A - Stather Road East	B - New Access Road	C - Stather Road West	
16:00 - 16:15	From	A - Stather Road East	0	22	0
		B - New Access Road	18	0	41
		C - Stather Road West	0	36	0

Demand (PCU/hr)

		To			
		A - Stather Road East	B - New Access Road	C - Stather Road West	
16:15 - 16:30	From	A - Stather Road East	0	22	0
		B - New Access Road	18	0	41
		C - Stather Road West	0	36	0

Demand (PCU/hr)

		To			
		A - Stather Road East	B - New Access Road	C - Stather Road West	
16:30 - 16:45	From	A - Stather Road East	0	9	0
		B - New Access Road	14	0	31
		C - Stather Road West	0	17	0

Demand (PCU/hr)

		To			
		A - Stather Road East	B - New Access Road	C - Stather Road West	
16:45 - 17:00	From	A - Stather Road East	0	22	0
		B - New Access Road	25	0	55
		C - Stather Road West	0	45	0

Vehicle Mix

Heavy Vehicle Percentages

		To			
		A - Stather Road East	B - New Access Road	C - Stather Road West	
16:00 - 16:15	From	A - Stather Road East	0	1	0
		B - New Access Road	2	0	3
		C - Stather Road West	0	3	0

Heavy Vehicle Percentages

		To			
		A - Stather Road East	B - New Access Road	C - Stather Road West	
16:15 - 16:30	From	A - Stather Road East	0	1	0
		B - New Access Road	2	0	3
		C - Stather Road West	0	3	0

Heavy Vehicle Percentages

		To			
		A - Stather Road East	B - New Access Road	C - Stather Road West	
16:30 - 16:45	From	A - Stather Road East	0	0	0
		B - New Access Road	2	0	2
		C - Stather Road West	0	1	0

Heavy Vehicle Percentages

		To			
		A - Stather Road East	B - New Access Road	C - Stather Road West	
16:45 - 17:00	From	A - Stather Road East	0	1	0
		B - New Access Road	3	0	4
		C - Stather Road West	0	3	0

Results

Results Summary for whole modelled period

Stream	Max RFC	Max Delay (s)	Max Queue (PCU)	Max LOS	Average Demand (PCU/hr)	Total Junction Arrivals (PCU)
B-AC	0.11	5.90	0.1	A	61	61
C-A					0	0
C-B	0.06	5.60	0.1	A	34	34
A-B					19	19
A-C					0	0

Main Results for each time segment

16:00 - 16:15

Stream	Total Demand (PCU/hr)	Junction Arrivals (PCU)	Capacity (PCU/hr)	RFC	Throughput (PCU/hr)	Start queue (PCU)	End queue (PCU)	Delay (s)	Unsignalised level of service
B-AC	59	15	711	0.083	59	0.0	0.1	5.663	A
C-A	0	0			0				
C-B	36	9	702	0.051	36	0.0	0.1	5.561	A
A-B	22	6			22				
A-C	0	0			0				

16:15 - 16:30

Stream	Total Demand (PCU/hr)	Junction Arrivals (PCU)	Capacity (PCU/hr)	RFC	Throughput (PCU/hr)	Start queue (PCU)	End queue (PCU)	Delay (s)	Unsignalised level of service
B-AC	59	15	711	0.083	59	0.1	0.1	5.668	A
C-A	0	0			0				
C-B	36	9	702	0.051	36	0.1	0.1	5.563	A
A-B	22	6			22				
A-C	0	0			0				

16:30 - 16:45

Stream	Total Demand (PCU/hr)	Junction Arrivals (PCU)	Capacity (PCU/hr)	RFC	Throughput (PCU/hr)	Start queue (PCU)	End queue (PCU)	Delay (s)	Unsignalised level of service
B-AC	45	11	715	0.063	45	0.1	0.1	5.507	A

C-A	0	0			0				
C-B	17	4	706	0.024	17	0.1	0.0	5.352	A
A-B	9	2			9				
A-C	0	0			0				

16:45 - 17:00

Stream	Total Demand (PCU/hr)	Junction Arrivals (PCU)	Capacity (PCU/hr)	RFC	Throughput (PCU/hr)	Start queue (PCU)	End queue (PCU)	Delay (s)	Unsignalised level of service
B-AC	80	20	708	0.113	80	0.1	0.1	5.896	A
C-A	0	0			0				
C-B	45	11	702	0.064	45	0.0	0.1	5.604	A
A-B	22	6			22				
A-C	0	0			0				

2028 + Committed Development No Development Traffic, AM

Data Errors and Warnings

No errors or warnings

Junction Network

Junctions

Junction	Name	Junction type	Major road direction	Use circulating lanes	Junction Delay (s)	Junction LOS
1	untitled	T-Junction	Two-way		4.89	A

Junction Network Options

Driving side	Lighting
Left	Normal/unknown

Traffic Demand

Demand Set Details

ID	Scenario name	Time Period name	Traffic profile type	Start time (HH:mm)	Finish time (HH:mm)	Time period length (min)	Time segment length (min)	Run automatically
D3	2028 + Committed Development No Development Traffic	AM	DIRECT	08:00	09:00	60	15	✓

Vehicle mix varies over time	Vehicle mix varies over turn	Vehicle mix varies over entry	Vehicle mix source	PCU Factor for a HV (PCU)	O-D data varies over time
✓	✓	✓	HV Percentages	2.00	✓

Demand overview (Traffic)

Arm	Linked arm	Profile type	Use O-D data	Scaling Factor (%)
A - Stather Road East		DIRECT	✓	100.000
B - New Access Road		DIRECT	✓	100.000
C - Stather Road West		DIRECT	✓	100.000

Origin-Destination Data

Demand (PCU/hr)

		To		
		A - Stather Road East	B - New Access Road	C - Stather Road West
08:00 - 08:15	From			
	A - Stather Road East	0	10	1
	B - New Access Road	8	0	51
	C - Stather Road West	0	19	0

Demand (PCU/hr)

		To		
		A - Stather Road East	B - New Access Road	C - Stather Road West
08:15 - 08:30	From			
	A - Stather Road East	0	17	1
	B - New Access Road	9	0	58
	C - Stather Road West	0	29	0

Demand (PCU/hr)

		To		
		A - Stather Road East	B - New Access Road	C - Stather Road West
08:30 - 08:45	From			
	A - Stather Road East	0	9	1
	B - New Access Road	7	0	44
	C - Stather Road West	0	17	0

Demand (PCU/hr)

		To		
		A - Stather Road East	B - New Access Road	C - Stather Road West
08:45 - 09:00	From			
	A - Stather Road East			
	B - New Access Road			
	C - Stather Road West			

From	A - Stather Road East	0	15	1
	B - New Access Road	11	0	69
	C - Stather Road West	0	19	0

Vehicle Mix

Heavy Vehicle Percentages

08:00 - 08:15	From	To			
			A - Stather Road East	B - New Access Road	C - Stather Road West
		A - Stather Road East	0	2	8
		B - New Access Road	2	0	3
	C - Stather Road West	0	8	0	

Heavy Vehicle Percentages

08:15 - 08:30	From	To			
			A - Stather Road East	B - New Access Road	C - Stather Road West
		A - Stather Road East	0	3	13
		B - New Access Road	2	0	4
	C - Stather Road West	0	12	0	

Heavy Vehicle Percentages

08:30 - 08:45	From	To			
			A - Stather Road East	B - New Access Road	C - Stather Road West
		A - Stather Road East	0	1	7
		B - New Access Road	1	0	3
	C - Stather Road West	0	7	0	

Heavy Vehicle Percentages

08:45 - 09:00	From	To			
			A - Stather Road East	B - New Access Road	C - Stather Road West
		A - Stather Road East	0	2	12
		B - New Access Road	2	0	4
	C - Stather Road West	0	8	0	

Results

Results Summary for whole modelled period

Stream	Max RFC	Max Delay (s)	Max Queue (PCU)	Max LOS	Average Demand (PCU/hr)	Total Junction Arrivals (PCU)
B-AC	0.11	5.61	0.1	A	64	64
C-A					0	0
C-B	0.04	5.89	0.0	A	21	21
A-B					13	13
A-C					1	1

Main Results for each time segment

08:00 - 08:15

Stream	Total Demand (PCU/hr)	Junction Arrivals (PCU)	Capacity (PCU/hr)	RFC	Throughput (PCU/hr)	Start queue (PCU)	End queue (PCU)	Delay (s)	Unsignalised level of service
B-AC	59	15	743	0.079	59	0.0	0.1	5.408	A
C-A	0	0			0				
C-B	19	5	705	0.027	19	0.0	0.0	5.665	A
A-B	10	3			10				
A-C	1	0.25			1				

08:15 - 08:30

Stream	Total Demand (PCU/hr)	Junction Arrivals (PCU)	Capacity (PCU/hr)	RFC	Throughput (PCU/hr)	Start queue (PCU)	End queue (PCU)	Delay (s)	Unsignalised level of service
B-AC	67	17	742	0.090	67	0.1	0.1	5.509	A
C-A	0	0			0				
C-B	29	7	703	0.041	29	0.0	0.0	5.887	A
A-B	17	4			17				
A-C	1	0.25			1				

08:30 - 08:45

Stream	Total Demand (PCU/hr)	Junction Arrivals (PCU)	Capacity (PCU/hr)	RFC	Throughput (PCU/hr)	Start queue (PCU)	End queue (PCU)	Delay (s)	Unsignalised level of service
B-AC	51	13	743	0.069	51	0.1	0.1	5.378	A
C-A	0	0			0				
C-B	17	4	705	0.024	17	0.0	0.0	5.763	A
A-B	9	2			9				
A-C	1	0.25			1				

08:45 - 09:00

Stream	Total Demand (PCU/hr)	Junction Arrivals (PCU)	Capacity (PCU/hr)	RFC	Throughput (PCU/hr)	Start queue (PCU)	End queue (PCU)	Delay (s)	Unsignalised level of service
B-AC	80	20	742	0.108	80	0.1	0.1	5.612	A
C-A	0	0			0				
C-B	19	5	704	0.027	19	0.0	0.0	5.650	A
A-B	15	4			15				
A-C	1	0.25			1				

2028 + Committed Development No Development Traffic, PM

Data Errors and Warnings

No errors or warnings

Junction Network

Junctions

Junction	Name	Junction type	Major road direction	Use circulating lanes	Junction Delay (s)	Junction LOS
1	untitled	T-Junction	Two-way		4.86	A

Junction Network Options

Driving side	Lighting
Left	Normal/unknown

Traffic Demand

Demand Set Details

ID	Scenario name	Time Period name	Traffic profile type	Start time (HH:mm)	Finish time (HH:mm)	Time period length (min)	Time segment length (min)	Run automatically
D4	2028 + Committed Development No Development Traffic	PM	DIRECT	16:00	17:00	60	15	✓

Vehicle mix varies over time	Vehicle mix varies over turn	Vehicle mix varies over entry	Vehicle mix source	PCU Factor for a HV (PCU)	O-D data varies over time
✓	✓	✓	HV Percentages	2.00	✓

Demand overview (Traffic)

Arm	Linked arm	Profile type	Use O-D data	Scaling Factor (%)
A - Stather Road East		DIRECT	✓	100.000
B - New Access Road		DIRECT	✓	100.000
C - Stather Road West		DIRECT	✓	100.000

Origin-Destination Data

Demand (PCU/hr)

		To		
		A - Stather Road East	B - New Access Road	C - Stather Road West
16:00 - 16:15	From			
	A - Stather Road East	0	22	0
	B - New Access Road	18	0	41
	C - Stather Road West	0.75	36	0

Demand (PCU/hr)

		To		
		A - Stather Road East	B - New Access Road	C - Stather Road West
16:15 - 16:30	From			
	A - Stather Road East	0	22	0
	B - New Access Road	18	0	41
	C - Stather Road West	0.75	36	0

Demand (PCU/hr)

		To		
		A - Stather Road East	B - New Access Road	C - Stather Road West
16:30 - 16:45	From			
	A - Stather Road East	0	9	0
	B - New Access Road	14	0	32
	C - Stather Road West	0.69	17	0

Demand (PCU/hr)

		To		
		A - Stather Road East	B - New Access Road	C - Stather Road West
16:45 - 17:00	From			
	A - Stather Road East			
	B - New Access Road			
	C - Stather Road West			

From	A - Stather Road East	0	22	0
	B - New Access Road	25	0	56
	C - Stather Road West	0.93	45	0

Vehicle Mix

Heavy Vehicle Percentages

16:00 - 16:15	From	To			
			A - Stather Road East	B - New Access Road	C - Stather Road West
		A - Stather Road East	0	1	0
		B - New Access Road	3	0	4
	C - Stather Road West	0	4	0	

Heavy Vehicle Percentages

16:15 - 16:30	From	To			
			A - Stather Road East	B - New Access Road	C - Stather Road West
		A - Stather Road East	0	1	0
		B - New Access Road	3	0	4
	C - Stather Road West	0	4	0	

Heavy Vehicle Percentages

16:30 - 16:45	From	To			
			A - Stather Road East	B - New Access Road	C - Stather Road West
		A - Stather Road East	0	1	0
		B - New Access Road	2	0	3
	C - Stather Road West	0	2	0	

Heavy Vehicle Percentages

16:45 - 17:00	From	To			
			A - Stather Road East	B - New Access Road	C - Stather Road West
		A - Stather Road East	0	1	0
		B - New Access Road	4	0	5
	C - Stather Road West	0	5	0	

Results

Results Summary for whole modelled period

Stream	Max RFC	Max Delay (s)	Max Queue (PCU)	Max LOS	Average Demand (PCU/hr)	Total Junction Arrivals (PCU)
B-AC	0.11	5.95	0.1	A	61	61
C-A					0.78	0.78
C-B	0.06	5.70	0.1	A	34	34
A-B					19	19
A-C					0	0

Main Results for each time segment

16:00 - 16:15

Stream	Total Demand (PCU/hr)	Junction Arrivals (PCU)	Capacity (PCU/hr)	RFC	Throughput (PCU/hr)	Start queue (PCU)	End queue (PCU)	Delay (s)	Unsignalised level of service
B-AC	59	15	711	0.083	59	0.0	0.1	5.719	A
C-A	0.75	0.19			0.75				
C-B	36	9	702	0.051	36	0.0	0.1	5.615	A
A-B	22	6			22				
A-C	0	0			0				

16:15 - 16:30

Stream	Total Demand (PCU/hr)	Junction Arrivals (PCU)	Capacity (PCU/hr)	RFC	Throughput (PCU/hr)	Start queue (PCU)	End queue (PCU)	Delay (s)	Unsignalised level of service
B-AC	59	15	711	0.083	59	0.1	0.1	5.723	A
C-A	0.75	0.19			0.75				
C-B	36	9	702	0.051	36	0.1	0.1	5.617	A
A-B	22	6			22				
A-C	0	0			0				

16:30 - 16:45

Stream	Total Demand (PCU/hr)	Junction Arrivals (PCU)	Capacity (PCU/hr)	RFC	Throughput (PCU/hr)	Start queue (PCU)	End queue (PCU)	Delay (s)	Unsignalised level of service
B-AC	46	12	716	0.064	46	0.1	0.1	5.555	A
C-A	0.69	0.17			0.69				
C-B	17	4	706	0.024	17	0.1	0.0	5.407	A
A-B	9	2			9				
A-C	0	0			0				

16:45 - 17:00

Stream	Total Demand (PCU/hr)	Junction Arrivals (PCU)	Capacity (PCU/hr)	RFC	Throughput (PCU/hr)	Start queue (PCU)	End queue (PCU)	Delay (s)	Unsignalised level of service
B-AC	81	20	709	0.114	81	0.1	0.1	5.951	A
C-A	0.93	0.23			0.93				
C-B	45	11	702	0.064	45	0.0	0.1	5.697	A
A-B	22	6			22				
A-C	0	0			0				

2028 + Committed Development + Development Traffic, AM

Data Errors and Warnings

No errors or warnings

Junction Network

Junctions

Junction	Name	Junction type	Major road direction	Use circulating lanes	Junction Delay (s)	Junction LOS
1	untitled	T-Junction	Two-way		4.93	A

Junction Network Options

Driving side	Lighting
Left	Normal/unknown

Traffic Demand

Demand Set Details

ID	Scenario name	Time Period name	Traffic profile type	Start time (HH:mm)	Finish time (HH:mm)	Time period length (min)	Time segment length (min)	Run automatically
D5	2028 + Committed Development + Development Traffic	AM	DIRECT	08:00	09:00	60	15	✓

Vehicle mix varies over time	Vehicle mix varies over turn	Vehicle mix varies over entry	Vehicle mix source	PCU Factor for a HV (PCU)	O-D data varies over time
✓	✓	✓	HV Percentages	2.00	✓

Demand overview (Traffic)

Arm	Linked arm	Profile type	Use O-D data	Scaling Factor (%)
A - Stather Road East		DIRECT	✓	100.000
B - New Access Road		DIRECT	✓	100.000
C - Stather Road West		DIRECT	✓	100.000

Origin-Destination Data

Demand (PCU/hr)

		To		
		A - Stather Road East	B - New Access Road	C - Stather Road West
08:00 - 08:15	From			
	A - Stather Road East	0	10	1
	B - New Access Road	8	0	53
	C - Stather Road West	0	20	0

Demand (PCU/hr)

		To		
		A - Stather Road East	B - New Access Road	C - Stather Road West
08:15 - 08:30	From			
	A - Stather Road East	0	17	1
	B - New Access Road	9	0	60
	C - Stather Road West	0	30	0

Demand (PCU/hr)

		To		
		A - Stather Road East	B - New Access Road	C - Stather Road West
08:30 - 08:45	From			
	A - Stather Road East	0	9	1
	B - New Access Road	7	0	46
	C - Stather Road West	0	17	0

Demand (PCU/hr)

		To		
		A - Stather Road East	B - New Access Road	C - Stather Road West
08:45 - 09:00	From			
	A - Stather Road East			
	B - New Access Road			
	C - Stather Road West			

From	A - Stather Road East	0	15	1
	B - New Access Road	11	0	72
	C - Stather Road West	0	20	0

Vehicle Mix

Heavy Vehicle Percentages

08:00 - 08:15	From	To			
			A - Stather Road East	B - New Access Road	C - Stather Road West
		A - Stather Road East	0	2	8
		B - New Access Road	2	0	3
	C - Stather Road West	7	8	0	

Heavy Vehicle Percentages

08:15 - 08:30	From	To			
			A - Stather Road East	B - New Access Road	C - Stather Road West
		A - Stather Road East	0	3	13
		B - New Access Road	2	0	4
	C - Stather Road West	0	12	0	

Heavy Vehicle Percentages

08:30 - 08:45	From	To			
			A - Stather Road East	B - New Access Road	C - Stather Road West
		A - Stather Road East	0	1	7
		B - New Access Road	1	0	3
	C - Stather Road West	0	7	0	

Heavy Vehicle Percentages

08:45 - 09:00	From	To			
			A - Stather Road East	B - New Access Road	C - Stather Road West
		A - Stather Road East	0	2	12
		B - New Access Road	2	0	4
	C - Stather Road West	0	8	0	

Results

Results Summary for whole modelled period

Stream	Max RFC	Max Delay (s)	Max Queue (PCU)	Max LOS	Average Demand (PCU/hr)	Total Junction Arrivals (PCU)
B-AC	0.11	5.63	0.1	A	67	67
C-A					0	0
C-B	0.04	5.89	0.0	A	22	22
A-B					13	13
A-C					1	1

Main Results for each time segment

08:00 - 08:15

Stream	Total Demand (PCU/hr)	Junction Arrivals (PCU)	Capacity (PCU/hr)	RFC	Throughput (PCU/hr)	Start queue (PCU)	End queue (PCU)	Delay (s)	Unsignalised level of service
B-AC	61	15	744	0.082	61	0.0	0.1	5.419	A
C-A	0	0			0				
C-B	20	5	705	0.028	20	0.0	0.0	5.673	A
A-B	10	3			10				
A-C	1	0.25			1				

08:15 - 08:30

Stream	Total Demand (PCU/hr)	Junction Arrivals (PCU)	Capacity (PCU/hr)	RFC	Throughput (PCU/hr)	Start queue (PCU)	End queue (PCU)	Delay (s)	Unsignalised level of service
B-AC	69	17	742	0.093	69	0.1	0.1	5.521	A
C-A	0	0			0				
C-B	30	8	703	0.043	30	0.0	0.0	5.895	A
A-B	17	4			17				
A-C	1	0.25			1				

08:30 - 08:45

Stream	Total Demand (PCU/hr)	Junction Arrivals (PCU)	Capacity (PCU/hr)	RFC	Throughput (PCU/hr)	Start queue (PCU)	End queue (PCU)	Delay (s)	Unsignalised level of service
B-AC	53	13	744	0.071	53	0.1	0.1	5.387	A
C-A	0	0			0				
C-B	17	4	705	0.024	17	0.0	0.0	5.763	A
A-B	9	2			9				
A-C	1	0.25			1				

08:45 - 09:00

Stream	Total Demand (PCU/hr)	Junction Arrivals (PCU)	Capacity (PCU/hr)	RFC	Throughput (PCU/hr)	Start queue (PCU)	End queue (PCU)	Delay (s)	Unsignalised level of service
B-AC	83	21	743	0.112	83	0.1	0.1	5.631	A
C-A	0	0			0				
C-B	20	5	704	0.028	20	0.0	0.0	5.659	A
A-B	15	4			15				
A-C	1	0.25			1				

2028 + Committed Development + Development Traffic, PM

Data Errors and Warnings

No errors or warnings

Junction Network

Junctions

Junction	Name	Junction type	Major road direction	Use circulating lanes	Junction Delay (s)	Junction LOS
1	untitled	T-Junction	Two-way		4.86	A

Junction Network Options

Driving side	Lighting
Left	Normal/unknown

Traffic Demand

Demand Set Details

ID	Scenario name	Time Period name	Traffic profile type	Start time (HH:mm)	Finish time (HH:mm)	Time period length (min)	Time segment length (min)	Run automatically
D6	2028 + Committed Development + Development Traffic	PM	DIRECT	16:00	17:00	60	15	✓

Vehicle mix varies over time	Vehicle mix varies over turn	Vehicle mix varies over entry	Vehicle mix source	PCU Factor for a HV (PCU)	O-D data varies over time
✓	✓	✓	HV Percentages	2.00	✓

Demand overview (Traffic)

Arm	Linked arm	Profile type	Use O-D data	Scaling Factor (%)
A - Stather Road East		DIRECT	✓	100.000
B - New Access Road		DIRECT	✓	100.000
C - Stather Road West		DIRECT	✓	100.000

Origin-Destination Data

Demand (PCU/hr)

		To		
		A - Stather Road East	B - New Access Road	C - Stather Road West
16:00 - 16:15	From			
	A - Stather Road East	0	22	0
	B - New Access Road	18	0	41
	C - Stather Road West	0.75	36	0

Demand (PCU/hr)

		To		
		A - Stather Road East	B - New Access Road	C - Stather Road West
16:15 - 16:30	From			
	A - Stather Road East	0	22	0
	B - New Access Road	18	0	41
	C - Stather Road West	0.75	36	0

Demand (PCU/hr)

		To		
		A - Stather Road East	B - New Access Road	C - Stather Road West
16:30 - 16:45	From			
	A - Stather Road East	0	9	0
	B - New Access Road	14	0	32
	C - Stather Road West	0.69	17	0

Demand (PCU/hr)

		To		
		A - Stather Road East	B - New Access Road	C - Stather Road West
16:45 - 17:00	From			
	A - Stather Road East			
	B - New Access Road			
	C - Stather Road West			

From	A - Stather Road East	0	22	0
	B - New Access Road	25	0	56
	C - Stather Road West	0.93	45	0

Vehicle Mix

Heavy Vehicle Percentages

16:00 - 16:15	From	To			
			A - Stather Road East	B - New Access Road	C - Stather Road West
		A - Stather Road East	0	1	0
		B - New Access Road	3	0	4
	C - Stather Road West	0	4	0	

Heavy Vehicle Percentages

16:15 - 16:30	From	To			
			A - Stather Road East	B - New Access Road	C - Stather Road West
		A - Stather Road East	0	1	0
		B - New Access Road	3	0	4
	C - Stather Road West	0	4	0	

Heavy Vehicle Percentages

16:30 - 16:45	From	To			
			A - Stather Road East	B - New Access Road	C - Stather Road West
		A - Stather Road East	0	1	0
		B - New Access Road	2	0	3
	C - Stather Road West	0	2	0	

Heavy Vehicle Percentages

16:45 - 17:00	From	To			
			A - Stather Road East	B - New Access Road	C - Stather Road West
		A - Stather Road East	0	1	0
		B - New Access Road	4	0	5
	C - Stather Road West	0	5	0	

Results

Results Summary for whole modelled period

Stream	Max RFC	Max Delay (s)	Max Queue (PCU)	Max LOS	Average Demand (PCU/hr)	Total Junction Arrivals (PCU)
B-AC	0.11	5.95	0.1	A	61	61
C-A					0.78	0.78
C-B	0.06	5.70	0.1	A	34	34
A-B					19	19
A-C					0	0

Main Results for each time segment

16:00 - 16:15

Stream	Total Demand (PCU/hr)	Junction Arrivals (PCU)	Capacity (PCU/hr)	RFC	Throughput (PCU/hr)	Start queue (PCU)	End queue (PCU)	Delay (s)	Unsignalised level of service
B-AC	59	15	711	0.083	59	0.0	0.1	5.719	A
C-A	0.75	0.19			0.75				
C-B	36	9	702	0.051	36	0.0	0.1	5.615	A
A-B	22	6			22				
A-C	0	0			0				

16:15 - 16:30

Stream	Total Demand (PCU/hr)	Junction Arrivals (PCU)	Capacity (PCU/hr)	RFC	Throughput (PCU/hr)	Start queue (PCU)	End queue (PCU)	Delay (s)	Unsignalised level of service
B-AC	59	15	711	0.083	59	0.1	0.1	5.723	A
C-A	0.75	0.19			0.75				
C-B	36	9	702	0.051	36	0.1	0.1	5.617	A
A-B	22	6			22				
A-C	0	0			0				

16:30 - 16:45

Stream	Total Demand (PCU/hr)	Junction Arrivals (PCU)	Capacity (PCU/hr)	RFC	Throughput (PCU/hr)	Start queue (PCU)	End queue (PCU)	Delay (s)	Unsignalised level of service
B-AC	46	12	716	0.064	46	0.1	0.1	5.555	A
C-A	0.69	0.17			0.69				
C-B	17	4	706	0.024	17	0.1	0.0	5.407	A
A-B	9	2			9				
A-C	0	0			0				

16:45 - 17:00

Stream	Total Demand (PCU/hr)	Junction Arrivals (PCU)	Capacity (PCU/hr)	RFC	Throughput (PCU/hr)	Start queue (PCU)	End queue (PCU)	Delay (s)	Unsignalised level of service
B-AC	81	20	709	0.114	81	0.1	0.1	5.951	A
C-A	0.93	0.23			0.93				
C-B	45	11	702	0.064	45	0.0	0.1	5.697	A
A-B	22	6			22				
A-C	0	0			0				

2038 + Committed Development + Development (Sensitivity Test), AM

Data Errors and Warnings

No errors or warnings

Junction Network

Junctions

Junction	Name	Junction type	Major road direction	Use circulating lanes	Junction Delay (s)	Junction LOS
1	untitled	T-Junction	Two-way		5.02	A

Junction Network Options

Driving side	Lighting
Left	Normal/unknown

Traffic Demand

Demand Set Details

ID	Scenario name	Time Period name	Traffic profile type	Start time (HH:mm)	Finish time (HH:mm)	Time period length (min)	Time segment length (min)	Run automatically
D8	2038 + Committed Development + Development (Sensitivity Test)	AM	DIRECT	08:00	09:00	60	15	✓

Vehicle mix varies over time	Vehicle mix varies over turn	Vehicle mix varies over entry	Vehicle mix source	PCU Factor for a HV (PCU)	O-D data varies over time
✓	✓	✓	HV Percentages	2.00	✓

Demand overview (Traffic)

Arm	Linked arm	Profile type	Use O-D data	Scaling Factor (%)
A - Stather Road East		DIRECT	✓	100.000
B - New Access Road		DIRECT	✓	100.000
C - Stather Road West		DIRECT	✓	100.000

Origin-Destination Data

Demand (PCU/hr)

		To		
		A - Stather Road East	B - New Access Road	C - Stather Road West
08:00 - 08:15	From			
	A - Stather Road East	0	10	1
	B - New Access Road	8	0	61
	C - Stather Road West	0	22	0

Demand (PCU/hr)

		To		
		A - Stather Road East	B - New Access Road	C - Stather Road West
08:15 - 08:30	From			
	A - Stather Road East	0	17	1
	B - New Access Road	9	0	69
	C - Stather Road West	0	33	0

Demand (PCU/hr)

		To		
		A - Stather Road East	B - New Access Road	C - Stather Road West
08:30 - 08:45	From			
	A - Stather Road East	0	9	1
	B - New Access Road	7	0	53
	C - Stather Road West	0	19	0

Demand (PCU/hr)

		To		
		A - Stather Road East	B - New Access Road	C - Stather Road West
08:45 - 09:00	From			
	A - Stather Road East			
	B - New Access Road			
	C - Stather Road West			

From	A - Stather Road East	0	15	1
	B - New Access Road	11	0	83
	C - Stather Road West	0	22	0

Vehicle Mix

Heavy Vehicle Percentages

08:00 - 08:15	From	To			
			A - Stather Road East	B - New Access Road	C - Stather Road West
		A - Stather Road East	0	2	8
		B - New Access Road	2	0	3
	C - Stather Road West	0	7	0	

Heavy Vehicle Percentages

08:15 - 08:30	From	To			
			A - Stather Road East	B - New Access Road	C - Stather Road West
		A - Stather Road East	0	3	13
		B - New Access Road	2	0	3
	C - Stather Road West	0	10	0	

Heavy Vehicle Percentages

08:30 - 08:45	From	To			
			A - Stather Road East	B - New Access Road	C - Stather Road West
		A - Stather Road East	0	1	7
		B - New Access Road	1	0	2
	C - Stather Road West	0	6	0	

Heavy Vehicle Percentages

08:45 - 09:00	From	To			
			A - Stather Road East	B - New Access Road	C - Stather Road West
		A - Stather Road East	0	2	12
		B - New Access Road	2	0	4
	C - Stather Road West	0	7	0	

Results

Results Summary for whole modelled period

Stream	Max RFC	Max Delay (s)	Max Queue (PCU)	Max LOS	Average Demand (PCU/hr)	Total Junction Arrivals (PCU)
B-AC	0.13	5.68	0.1	A	75	75
C-A					0	0
C-B	0.05	5.84	0.1	A	24	24
A-B					13	13
A-C					1	1

Main Results for each time segment

08:00 - 08:15

Stream	Total Demand (PCU/hr)	Junction Arrivals (PCU)	Capacity (PCU/hr)	RFC	Throughput (PCU/hr)	Start queue (PCU)	End queue (PCU)	Delay (s)	Unsignalised level of service
B-AC	69	17	746	0.092	69	0.0	0.1	5.461	A
C-A	0	0			0				
C-B	22	6	705	0.031	22	0.0	0.0	5.635	A
A-B	10	3			10				
A-C	1	0.25			1				

08:15 - 08:30

Stream	Total Demand (PCU/hr)	Junction Arrivals (PCU)	Capacity (PCU/hr)	RFC	Throughput (PCU/hr)	Start queue (PCU)	End queue (PCU)	Delay (s)	Unsignalised level of service
B-AC	78	20	745	0.105	78	0.1	0.1	5.553	A
C-A	0	0			0				
C-B	33	8	703	0.047	33	0.0	0.1	5.837	A
A-B	17	4			17				
A-C	1	0.25			1				

08:30 - 08:45

Stream	Total Demand (PCU/hr)	Junction Arrivals (PCU)	Capacity (PCU/hr)	RFC	Throughput (PCU/hr)	Start queue (PCU)	End queue (PCU)	Delay (s)	Unsignalised level of service
B-AC	60	15	746	0.080	60	0.1	0.1	5.378	A
C-A	0	0			0				
C-B	19	5	705	0.027	19	0.1	0.0	5.694	A
A-B	9	2			9				
A-C	1	0.25			1				

08:45 - 09:00

Stream	Total Demand (PCU/hr)	Junction Arrivals (PCU)	Capacity (PCU/hr)	RFC	Throughput (PCU/hr)	Start queue (PCU)	End queue (PCU)	Delay (s)	Unsignalised level of service
B-AC	94	24	746	0.126	94	0.1	0.1	5.683	A
C-A	0	0			0				
C-B	22	6	704	0.031	22	0.0	0.0	5.622	A
A-B	15	4			15				
A-C	1	0.25			1				

2038 + Committed Development + Development (Sensitivity Test), PM

Data Errors and Warnings

No errors or warnings

Junction Network

Junctions

Junction	Name	Junction type	Major road direction	Use circulating lanes	Junction Delay (s)	Junction LOS
1	untitled	T-Junction	Two-way		4.79	A

Junction Network Options

Driving side	Lighting
Left	Normal/unknown

Traffic Demand

Demand Set Details

ID	Scenario name	Time Period name	Traffic profile type	Start time (HH:mm)	Finish time (HH:mm)	Time period length (min)	Time segment length (min)	Run automatically
D9	2038 + Committed Development + Development (Sensitivity Test)	PM	DIRECT	16:00	17:00	60	15	✓

Vehicle mix varies over time	Vehicle mix varies over turn	Vehicle mix varies over entry	Vehicle mix source	PCU Factor for a HV (PCU)	O-D data varies over time
✓	✓	✓	HV Percentages	2.00	✓

Demand overview (Traffic)

Arm	Linked arm	Profile type	Use O-D data	Scaling Factor (%)
A - Stather Road East		DIRECT	✓	100.000
B - New Access Road		DIRECT	✓	100.000
C - Stather Road West		DIRECT	✓	100.000

Origin-Destination Data

Demand (PCU/hr)

		To		
		A - Stather Road East	B - New Access Road	C - Stather Road West
16:00 - 16:15	From			
	A - Stather Road East	0	22	0
	B - New Access Road	18	0	44
	C - Stather Road West	3	36	0

Demand (PCU/hr)

		To		
		A - Stather Road East	B - New Access Road	C - Stather Road West
16:15 - 16:30	From			
	A - Stather Road East	0	22	0
	B - New Access Road	18	0	44
	C - Stather Road West	3	36	0

Demand (PCU/hr)

		To		
		A - Stather Road East	B - New Access Road	C - Stather Road West
16:30 - 16:45	From			
	A - Stather Road East	0	9	0
	B - New Access Road	14	0	33
	C - Stather Road West	3	17	0

Demand (PCU/hr)

		To		
		A - Stather Road East	B - New Access Road	C - Stather Road West
16:45 - 17:00	From			
	A - Stather Road East			
	B - New Access Road			
	C - Stather Road West			

From	A - Stather Road East	0	22	0
	B - New Access Road	25	0	60
	C - Stather Road West	4	45	0

Vehicle Mix

Heavy Vehicle Percentages

16:00 - 16:15	From	To			
			A - Stather Road East	B - New Access Road	C - Stather Road West
		A - Stather Road East	0	1	0
		B - New Access Road	3	0	4
	C - Stather Road West	0	4	0	

Heavy Vehicle Percentages

16:15 - 16:30	From	To			
			A - Stather Road East	B - New Access Road	C - Stather Road West
		A - Stather Road East	0	1	0
		B - New Access Road	0	0	4
	C - Stather Road West	0	4	0	

Heavy Vehicle Percentages

16:30 - 16:45	From	To			
			A - Stather Road East	B - New Access Road	C - Stather Road West
		A - Stather Road East	0	1	0
		B - New Access Road	2	0	3
	C - Stather Road West	0	2	0	

Heavy Vehicle Percentages

16:45 - 17:00	From	To			
			A - Stather Road East	B - New Access Road	C - Stather Road West
		A - Stather Road East	0	1	0
		B - New Access Road	4	0	5
	C - Stather Road West	0	5	0	

Results

Results Summary for whole modelled period

Stream	Max RFC	Max Delay (s)	Max Queue (PCU)	Max LOS	Average Demand (PCU/hr)	Total Junction Arrivals (PCU)
B-AC	0.12	5.97	0.1	A	64	64
C-A					3	3
C-B	0.06	5.70	0.1	A	34	34
A-B					19	19
A-C					0	0

Main Results for each time segment

16:00 - 16:15

Stream	Total Demand (PCU/hr)	Junction Arrivals (PCU)	Capacity (PCU/hr)	RFC	Throughput (PCU/hr)	Start queue (PCU)	End queue (PCU)	Delay (s)	Unsignalised level of service
B-AC	62	16	713	0.087	62	0.0	0.1	5.723	A
C-A	3	0.81			3				
C-B	36	9	702	0.051	36	0.0	0.1	5.615	A
A-B	22	6			22				
A-C	0	0			0				

16:15 - 16:30

Stream	Total Demand (PCU/hr)	Junction Arrivals (PCU)	Capacity (PCU/hr)	RFC	Throughput (PCU/hr)	Start queue (PCU)	End queue (PCU)	Delay (s)	Unsignalised level of service
B-AC	62	16	713	0.087	62	0.1	0.1	5.708	A
C-A	3	0.81			3				
C-B	36	9	702	0.051	36	0.1	0.1	5.617	A
A-B	22	6			22				
A-C	0	0			0				

16:30 - 16:45

Stream	Total Demand (PCU/hr)	Junction Arrivals (PCU)	Capacity (PCU/hr)	RFC	Throughput (PCU/hr)	Start queue (PCU)	End queue (PCU)	Delay (s)	Unsignalised level of service
B-AC	47	12	717	0.066	47	0.1	0.1	5.528	A
C-A	3	0.75			3				
C-B	17	4	706	0.024	17	0.1	0.0	5.407	A
A-B	9	2			9				
A-C	0	0			0				

16:45 - 17:00

Stream	Total Demand (PCU/hr)	Junction Arrivals (PCU)	Capacity (PCU/hr)	RFC	Throughput (PCU/hr)	Start queue (PCU)	End queue (PCU)	Delay (s)	Unsignalised level of service
B-AC	85	21	711	0.119	85	0.1	0.1	5.965	A
C-A	4	1			4				
C-B	45	11	702	0.064	45	0.0	0.1	5.697	A
A-B	22	6			22				
A-C	0	0			0				

Appendix K ARCADY Results – B1216 Ferry West Road / New Access Road Roundabout

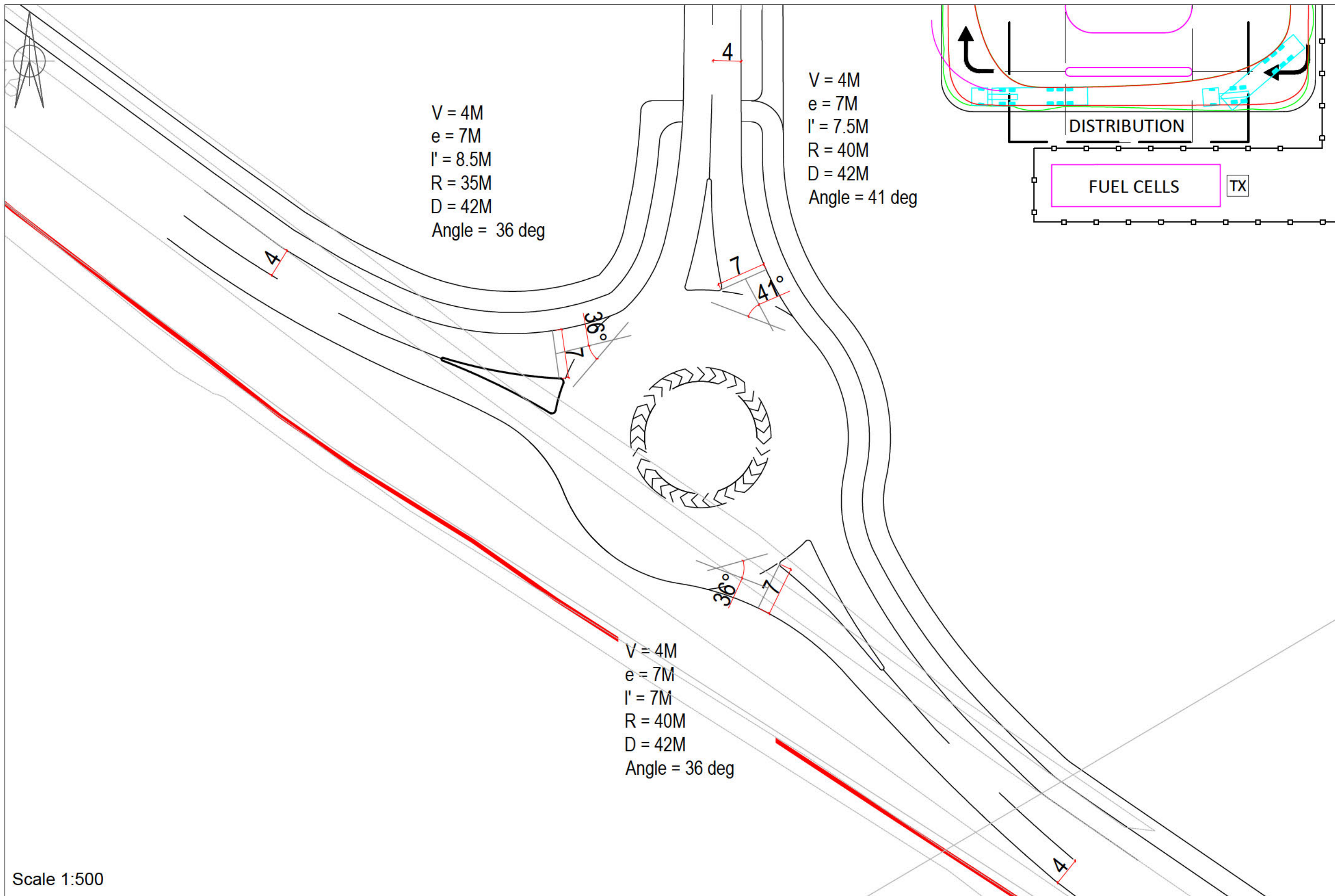

	Project: North Lincolnshire Green Energy Park (NLGEP)	Project Number: 0046658	Status: FOR INFORMATION		
	Sketch Title: New Access Road - Ferry Road West Roundabout ARCADY Modelling Parameters	Sketch Number: SK07	Date: 10/05/21	Initials: JW	Revision: 0000

Junctions 9
ARCADY 9 - Roundabout Module
Version: 9.5.0.6896 © Copyright TRL Limited, 2018
For sales and distribution information, program advice and maintenance, contact TRL: +44 (0)1344 379777 software@trl.co.uk
The users of this computer program for the solution of an engineering problem are in no way relieved of their responsibility for the correctness of the solution

Filename: New Link Road_ Ferry Road West Roundabout Direct Demand.j9
Path: C:\Users\vlomas\BuroHappold\046658 North Lincs Green Energy Park - 33_Transport Engineering\01 Assessments\Junction Assessments\ARCADY\Option 1 - B1216 New Roundabout
Report generation date: 14/01/2022 11:46:01

- »2022 Observed Flows, AM
- »2022 Observed Flows, PM
- »2028 + Committed Development No Development Traffic, AM
- »2028 + Committed Development No Development Traffic, PM
- »2028 + Committed Development + Development Traffic, AM
- »2028 + Committed Development + Development Traffic, PM
- »2038 + Committed Development + Development (Sensitivity Test), AM
- »2038 + Committed Development + Development (Sensitivity Test), PM

Summary of junction performance

	AM					PM				
	Queue (PCU)	Delay (s)	RFC	LOS	Junction Delay (s)	Queue (PCU)	Delay (s)	RFC	LOS	Junction Delay (s)
2022 Observed Flows										
1 - New Access Road	0.0	2.56	0.04	A	2.54	0.1	2.48	0.05	A	2.46
2 - B1216 Ferry Road East	0.1	2.56	0.06	A		0.1	2.52	0.05	A	
3 - B1216 Ferry Road West	0.0	2.47	0.03	A		0.0	2.35	0.03	A	
2028 + Committed Development No Development Traffic										
1 - New Access Road	0.1	2.78	0.05	A	2.67	0.1	2.62	0.07	A	2.60
2 - B1216 Ferry Road East	0.1	2.67	0.07	A		0.1	2.68	0.06	A	
3 - B1216 Ferry Road West	0.0	2.53	0.03	A		0.0	2.40	0.03	A	
2028 + Committed Development + Development Traffic										
1 - New Access Road	0.1	2.78	0.05	A	2.66	0.1	2.62	0.07	A	2.59
2 - B1216 Ferry Road East	0.1	2.65	0.07	A		0.1	2.67	0.06	A	
3 - B1216 Ferry Road West	0.0	2.54	0.03	A		0.0	2.40	0.03	A	
2038 + Committed Development + Development (Sensitivity Test)										
1 - New Access Road	0.1	2.76	0.06	A	2.65	0.1	2.62	0.07	A	2.59
2 - B1216 Ferry Road East	0.1	2.65	0.08	A		0.1	2.66	0.07	A	
3 - B1216 Ferry Road West	0.0	2.52	0.04	A		0.0	2.40	0.03	A	

Values shown are the highest values encountered over all time segments. Delay is the maximum value of average delay per arriving vehicle. Junction LOS and Junction Delay are demand-weighted averages.

File summary

File Description

Title	Option 1 - B1216 / New Access Road
Location	Scunthorpe
Site number	
Date	20/01/2021
Version	
Status	(new file)
Identifier	
Client	
Jobnumber	
Enumerator	BUROHAPPOLD\vlomas
Description	

Units

Distance units	Speed units	Traffic units input	Traffic units results	Flow units	Average delay units	Total delay units	Rate of delay units
m	kph	PCU	PCU	perHour	s	-Min	perMin

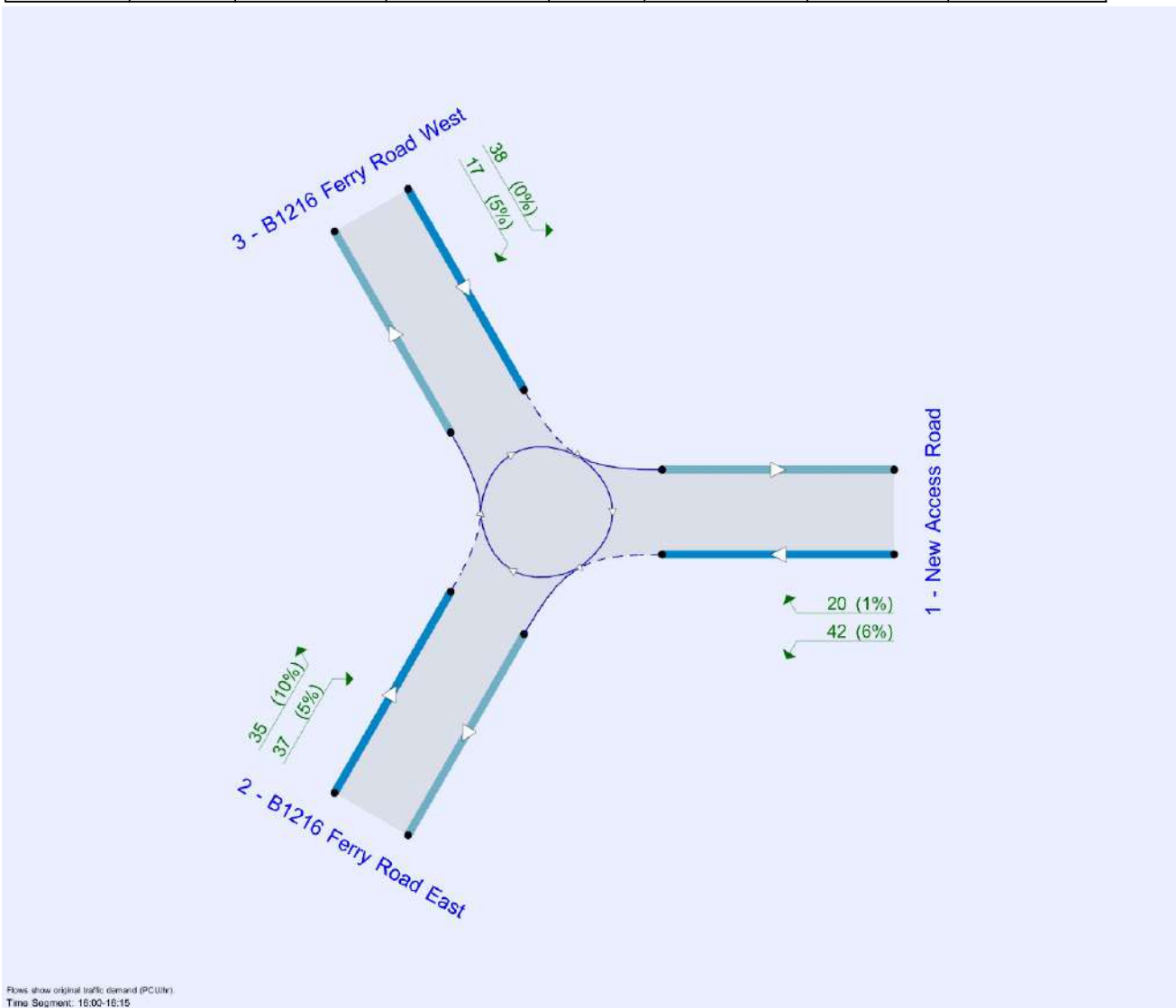

Analysis Options

Vehicle length (m)	Calculate Queue Percentiles	Calculate detailed queueing delay	Calculate residual capacity	RFC Threshold	Average Delay threshold (s)	Queue threshold (PCU)
5.75				0.85	36.00	20.00

Demand Set Summary

ID	Scenario name	Time Period name	Traffic profile type	Start time (HH:mm)	Finish time (HH:mm)	Time period length (min)	Time segment length (min)	Run automatically
D7	2022 Observed Flows	AM	DIRECT	08:00	09:00	60	15	✓
D8	2022 Observed Flows	PM	DIRECT	16:00	17:00	60	15	✓
D11	2028 + Committed Development No Development Traffic	AM	DIRECT	08:00	09:00	60	15	✓
D12	2028 + Committed Development No Development Traffic	PM	DIRECT	16:00	17:00	60	15	✓
D13	2028 + Committed Development + Development Traffic	AM	DIRECT	08:00	09:00	60	15	✓
D14	2028 + Committed Development + Development Traffic	PM	DIRECT	16:00	17:00	60	15	✓
D15	2038 + Committed Development + Development (Sensitivity Test)	AM	DIRECT	08:00	09:00	60	15	✓
D16	2038 + Committed Development + Development (Sensitivity Test)	PM	DIRECT	16:00	17:00	60	15	✓

Analysis Set Details

ID	Include in report	Network flow scaling factor (%)	Network capacity scaling factor (%)
A1	✓	100.000	100.000

2022 Observed Flows, AM

Data Errors and Warnings

No errors or warnings

Junction Network

Junctions

Junction	Name	Junction type	Use circulating lanes	Arm order	Junction Delay (s)	Junction LOS
1	untitled	Standard Roundabout		1, 2, 3	2.54	A

Junction Network Options

Driving side	Lighting
Left	Normal/unknown

Arms

Arms

Arm	Name	Description
1	New Access Road	
2	B1216 Ferry Road East	
3	B1216 Ferry Road West	

Roundabout Geometry

Arm	V - Approach road half-width (m)	E - Entry width (m)	I' - Effective flare length (m)	R - Entry radius (m)	D - Inscribed circle diameter (m)	PHI - Conflict (entry) angle (deg)	Exit only
1 - New Access Road	4.00	7.00	7.5	40.0	42.0	41.0	
2 - B1216 Ferry Road East	4.00	7.00	7.0	40.0	42.0	36.0	
3 - B1216 Ferry Road West	4.00	7.00	8.5	35.0	42.0	36.0	

Slope / Intercept / Capacity

Roundabout Slope and Intercept used in model

Arm	Final slope	Final intercept (PCU/hr)
1 - New Access Road	0.611	1589
2 - B1216 Ferry Road East	0.618	1601
3 - B1216 Ferry Road West	0.625	1639

The slope and intercept shown above include any corrections and adjustments.

Traffic Demand

Demand Set Details

ID	Scenario name	Time Period name	Traffic profile type	Start time (HH:mm)	Finish time (HH:mm)	Time period length (min)	Time segment length (min)	Run automatically
D7	2022 Observed Flows	AM	DIRECT	08:00	09:00	60	15	✓

Vehicle mix varies over time	Vehicle mix varies over turn	Vehicle mix varies over entry	Vehicle mix source	PCU Factor for a HV (PCU)	O-D data varies over time
✓	✓	✓	HV Percentages	2.00	✓

Demand overview (Traffic)

Arm	Linked arm	Profile type	Use O-D data	Scaling Factor (%)
1 - New Access Road		DIRECT	✓	100.000
2 - B1216 Ferry Road East		DIRECT	✓	100.000
3 - B1216 Ferry Road West		DIRECT	✓	100.000

Origin-Destination Data

Demand (PCU/hr)

		To			
		1 - New Access Road	2 - B1216 Ferry Road East	3 - B1216 Ferry Road West	
08:00 - 08:15	From	1 - New Access Road	0	17	7
		2 - B1216 Ferry Road East	48	0	14
		3 - B1216 Ferry Road West	4	13	0

Demand (PCU/hr)

		To			
		1 - New Access Road	2 - B1216 Ferry Road East	3 - B1216 Ferry Road West	
08:15 - 08:30	From	1 - New Access Road	0	44	17
		2 - B1216 Ferry Road East	48	0	11
		3 - B1216 Ferry Road West	11	15	0

Demand (PCU/hr)

		To			
		1 - New Access Road	2 - B1216 Ferry Road East	3 - B1216 Ferry Road West	
08:30 - 08:45	From	1 - New Access Road	0	17	7
		2 - B1216 Ferry Road East	48	0	25
		3 - B1216 Ferry Road West	15	37	0

Demand (PCU/hr)

		To			
		1 - New Access Road	2 - B1216 Ferry Road East	3 - B1216 Ferry Road West	
08:45 - 09:00	From	1 - New Access Road	0	17	7
		2 - B1216 Ferry Road East	74	0	17
		3 - B1216 Ferry Road West	18	25	0

Vehicle Mix

Heavy Vehicle Percentages

		To			
		1 - New Access Road	2 - B1216 Ferry Road East	3 - B1216 Ferry Road West	
08:00 - 08:15	From	1 - New Access Road	0	4	2
		2 - B1216 Ferry Road East	3	0	12
		3 - B1216 Ferry Road West	0	3	0

Heavy Vehicle Percentages

		To			
		1 - New Access Road	2 - B1216 Ferry Road East	3 - B1216 Ferry Road West	
08:15 - 08:30	From	1 - New Access Road	0	10	3
		2 - B1216 Ferry Road East	3	0	9
		3 - B1216 Ferry Road West	1	4	0

Heavy Vehicle Percentages

		To			
		1 - New Access Road	2 - B1216 Ferry Road East	3 - B1216 Ferry Road West	
08:30 - 08:45	From	1 - New Access Road	0	4	1
		2 - B1216 Ferry Road East	3	0	21
		3 - B1216 Ferry Road West	2	9	0

Heavy Vehicle Percentages

08:45 - 09:00

		To		
From		1 - New Access Road	2 - B1216 Ferry Road East	3 - B1216 Ferry Road West
	1 - New Access Road	0	4	3
	2 - B1216 Ferry Road East	5	0	15
	3 - B1216 Ferry Road West	2	6	0

Results

Results Summary for whole modelled period

Arm	Max RFC	Max Delay (s)	Max Queue (PCU)	Max LOS	Average Demand (PCU/hr)	Total Junction Arrivals (PCU)
1 - New Access Road	0.04	2.56	0.0	A	33	33
2 - B1216 Ferry Road East	0.06	2.56	0.1	A	71	71
3 - B1216 Ferry Road West	0.03	2.47	0.0	A	35	35

Main Results for each time segment

08:00 - 08:15

Arm	Total Demand (PCU/hr)	Junction Arrivals (PCU)	Circulating flow (PCU/hr)	Capacity (PCU/hr)	RFC	Throughput (PCU/hr)	Throughput (exit side) (PCU/hr)	Start queue (PCU)	End queue (PCU)	Delay (s)	Unsignalised level of service
1 - New Access Road	24	6	13	1581	0.015	24	52	0.0	0.0	2.391	A
2 - B1216 Ferry Road East	62	16	7	1597	0.039	62	30	0.0	0.0	2.460	A
3 - B1216 Ferry Road West	17	4	48	1609	0.011	17	21	0.0	0.0	2.312	A

08:15 - 08:30

Arm	Total Demand (PCU/hr)	Junction Arrivals (PCU)	Circulating flow (PCU/hr)	Capacity (PCU/hr)	RFC	Throughput (PCU/hr)	Throughput (exit side) (PCU/hr)	Start queue (PCU)	End queue (PCU)	Delay (s)	Unsignalised level of service
1 - New Access Road	61	15	15	1579	0.039	61	59	0.0	0.0	2.558	A
2 - B1216 Ferry Road East	59	15	17	1591	0.037	59	59	0.0	0.0	2.447	A
3 - B1216 Ferry Road West	26	7	48	1609	0.016	26	28	0.0	0.0	2.335	A

08:30 - 08:45

Arm	Total Demand (PCU/hr)	Junction Arrivals (PCU)	Circulating flow (PCU/hr)	Capacity (PCU/hr)	RFC	Throughput (PCU/hr)	Throughput (exit side) (PCU/hr)	Start queue (PCU)	End queue (PCU)	Delay (s)	Unsignalised level of service
1 - New Access Road	24	6	37	1566	0.015	24	63	0.0	0.0	2.407	A
2 - B1216 Ferry Road East	73	18	7	1597	0.046	73	54	0.0	0.1	2.563	A
3 - B1216 Ferry Road West	52	13	48	1609	0.032	52	32	0.0	0.0	2.470	A

08:45 - 09:00

Arm	Total Demand (PCU/hr)	Junction Arrivals (PCU)	Circulating flow (PCU/hr)	Capacity (PCU/hr)	RFC	Throughput (PCU/hr)	Throughput (exit side) (PCU/hr)	Start queue (PCU)	End queue (PCU)	Delay (s)	Unsignalised level of service
1 - New Access Road	24	6	25	1573	0.015	24	92	0.0	0.0	2.411	A
2 - B1216 Ferry Road East	91	23	7	1597	0.057	91	42	0.1	0.1	2.551	A
3 - B1216 Ferry Road West	43	11	74	1593	0.027	43	24	0.0	0.0	2.424	A

2022 Observed Flows, PM

Data Errors and Warnings

No errors or warnings

Junction Network

Junctions

Junction	Name	Junction type	Use circulating lanes	Arm order	Junction Delay (s)	Junction LOS
1	untitled	Standard Roundabout		1, 2, 3	2.46	A

Junction Network Options

Driving side	Lighting
Left	Normal/unknown

Traffic Demand

Demand Set Details

ID	Scenario name	Time Period name	Traffic profile type	Start time (HH:mm)	Finish time (HH:mm)	Time period length (min)	Time segment length (min)	Run automatically
D8	2022 Observed Flows	PM	DIRECT	16:00	17:00	60	15	✓

Vehicle mix varies over time	Vehicle mix varies over turn	Vehicle mix varies over entry	Vehicle mix source	PCU Factor for a HV (PCU)	O-D data varies over time
✓	✓	✓	HV Percentages	2.00	✓

Demand overview (Traffic)

Arm	Linked arm	Profile type	Use O-D data	Scaling Factor (%)
1 - New Access Road		DIRECT	✓	100.000
2 - B1216 Ferry Road East		DIRECT	✓	100.000
3 - B1216 Ferry Road West		DIRECT	✓	100.000

Origin-Destination Data

Demand (PCU/hr)

		To		
		1 - New Access Road	2 - B1216 Ferry Road East	3 - B1216 Ferry Road West
16:00 - 16:15	From			
	1 - New Access Road	0	27	20
	2 - B1216 Ferry Road East	23	0	35
	3 - B1216 Ferry Road West	34	17	0

Demand (PCU/hr)

		To		
		1 - New Access Road	2 - B1216 Ferry Road East	3 - B1216 Ferry Road West
16:15 - 16:30	From			
	1 - New Access Road	0	38	28
	2 - B1216 Ferry Road East	23	0	18
	3 - B1216 Ferry Road West	15	12	0

Demand (PCU/hr)

		To			
		1 - New Access Road	2 - B1216 Ferry Road East	3 - B1216 Ferry Road West	
16:30 - 16:45	From	1 - New Access Road	0	46	34
		2 - B1216 Ferry Road East	33	0	15
		3 - B1216 Ferry Road West	15	24	0

Demand (PCU/hr)

		To			
		1 - New Access Road	2 - B1216 Ferry Road East	3 - B1216 Ferry Road West	
16:45 - 17:00	From	1 - New Access Road	0	41	30
		2 - B1216 Ferry Road East	49	0	25
		3 - B1216 Ferry Road West	29	17	0

Vehicle Mix

Heavy Vehicle Percentages

		To			
		1 - New Access Road	2 - B1216 Ferry Road East	3 - B1216 Ferry Road West	
16:00 - 16:15	From	1 - New Access Road	0	3	0
		2 - B1216 Ferry Road East	3	0	7
		3 - B1216 Ferry Road West	0	4	0

Heavy Vehicle Percentages

		To			
		1 - New Access Road	2 - B1216 Ferry Road East	3 - B1216 Ferry Road West	
16:15 - 16:30	From	1 - New Access Road	0	4	0
		2 - B1216 Ferry Road East	5	0	3
		3 - B1216 Ferry Road West	0	3	0

Heavy Vehicle Percentages

		To			
		1 - New Access Road	2 - B1216 Ferry Road East	3 - B1216 Ferry Road West	
16:30 - 16:45	From	1 - New Access Road	0	5	0
		2 - B1216 Ferry Road East	4	0	3
		3 - B1216 Ferry Road West	0	5	0

Heavy Vehicle Percentages

		To			
		1 - New Access Road	2 - B1216 Ferry Road East	3 - B1216 Ferry Road West	
16:45 - 17:00	From	1 - New Access Road	0	5	0
		2 - B1216 Ferry Road East	6	0	5
		3 - B1216 Ferry Road West	0	4	0

Results

Results Summary for whole modelled period

Arm	Max RFC	Max Delay (s)	Max Queue (PCU)	Max LOS	Average Demand (PCU/hr)	Total Junction Arrivals (PCU)
1 - New Access Road	0.05	2.48	0.1	A	66	66
2 - B1216 Ferry Road East	0.05	2.52	0.1	A	55	55
3 - B1216 Ferry Road West	0.03	2.35	0.0	A	41	41

Main Results for each time segment

16:00 - 16:15

Arm	Total Demand (PCU/hr)	Junction Arrivals (PCU)	Circulating flow (PCU/hr)	Capacity (PCU/hr)	RFC	Throughput (PCU/hr)	Throughput (exit side) (PCU/hr)	Start queue (PCU)	End queue (PCU)	Delay (s)	Unsignalised level of service
1 - New Access Road	47	12	17	1578	0.030	47	57	0.0	0.0	2.390	A
2 - B1216 Ferry Road East	58	15	20	1589	0.037	58	44	0.0	0.0	2.477	A
3 - B1216 Ferry Road West	51	13	23	1625	0.031	51	55	0.0	0.0	2.316	A

16:15 - 16:30

Arm	Total Demand (PCU/hr)	Junction Arrivals (PCU)	Circulating flow (PCU/hr)	Capacity (PCU/hr)	RFC	Throughput (PCU/hr)	Throughput (exit side) (PCU/hr)	Start queue (PCU)	End queue (PCU)	Delay (s)	Unsignalised level of service
1 - New Access Road	66	17	12	1581	0.042	66	38	0.0	0.0	2.429	A
2 - B1216 Ferry Road East	41	10	28	1584	0.026	41	50	0.0	0.0	2.429	A
3 - B1216 Ferry Road West	27	7	23	1625	0.017	27	46	0.0	0.0	2.284	A

16:30 - 16:45

Arm	Total Demand (PCU/hr)	Junction Arrivals (PCU)	Circulating flow (PCU/hr)	Capacity (PCU/hr)	RFC	Throughput (PCU/hr)	Throughput (exit side) (PCU/hr)	Start queue (PCU)	End queue (PCU)	Delay (s)	Unsignalised level of service
1 - New Access Road	80	20	24	1574	0.051	80	48	0.0	0.1	2.477	A
2 - B1216 Ferry Road East	48	12	34	1580	0.030	48	70	0.0	0.0	2.435	A
3 - B1216 Ferry Road West	39	10	33	1619	0.024	39	49	0.0	0.0	2.347	A

16:45 - 17:00

Arm	Total Demand (PCU/hr)	Junction Arrivals (PCU)	Circulating flow (PCU/hr)	Capacity (PCU/hr)	RFC	Throughput (PCU/hr)	Throughput (exit side) (PCU/hr)	Start queue (PCU)	End queue (PCU)	Delay (s)	Unsignalised level of service
1 - New Access Road	71	18	17	1578	0.045	71	78	0.1	0.0	2.457	A
2 - B1216 Ferry Road East	74	19	30	1583	0.047	74	58	0.0	0.1	2.520	A
3 - B1216 Ferry Road West	46	12	49	1609	0.029	46	55	0.0	0.0	2.336	A

2028 + Committed Development No Development Traffic, AM

Data Errors and Warnings

No errors or warnings

Junction Network

Junctions

Junction	Name	Junction type	Use circulating lanes	Arm order	Junction Delay (s)	Junction LOS
1	untitled	Standard Roundabout		1, 2, 3	2.67	A

Junction Network Options

Driving side	Lighting
Left	Normal/unknown

Traffic Demand

Demand Set Details

ID	Scenario name	Time Period name	Traffic profile type	Start time (HH:mm)	Finish time (HH:mm)	Time period length (min)	Time segment length (min)	Run automatically
D11	2028 + Committed Development No Development Traffic	AM	DIRECT	08:00	09:00	60	15	✓

Vehicle mix varies over time	Vehicle mix varies over turn	Vehicle mix varies over entry	Vehicle mix source	PCU Factor for a HV (PCU)	O-D data varies over time
✓	✓	✓	HV Percentages	2.00	✓

Demand overview (Traffic)

Arm	Linked arm	Profile type	Use O-D data	Scaling Factor (%)
1 - New Access Road		DIRECT	✓	100.000
2 - B1216 Ferry Road East		DIRECT	✓	100.000
3 - B1216 Ferry Road West		DIRECT	✓	100.000

Origin-Destination Data

Demand (PCU/hr)

		To		
		1 - New Access Road	2 - B1216 Ferry Road East	3 - B1216 Ferry Road West
08:00 - 08:15	From			
	1 - New Access Road	0	27	7
	2 - B1216 Ferry Road East	63	0	14
	3 - B1216 Ferry Road West	4	13	0

Demand (PCU/hr)

		To		
		1 - New Access Road	2 - B1216 Ferry Road East	3 - B1216 Ferry Road West
08:15 - 08:30	From			
	1 - New Access Road	0	68	17
	2 - B1216 Ferry Road East	63	0	11
	3 - B1216 Ferry Road West	11	15	0

Demand (PCU/hr)

		To			
		1 - New Access Road	2 - B1216 Ferry Road East	3 - B1216 Ferry Road West	
08:30 - 08:45	From	1 - New Access Road	0	27	7
		2 - B1216 Ferry Road East	63	0	25
		3 - B1216 Ferry Road West	15	37	0

Demand (PCU/hr)

		To			
		1 - New Access Road	2 - B1216 Ferry Road East	3 - B1216 Ferry Road West	
08:45 - 09:00	From	1 - New Access Road	0	27	7
		2 - B1216 Ferry Road East	96	0	17
		3 - B1216 Ferry Road West	18	25	0

Vehicle Mix

Heavy Vehicle Percentages

		To			
		1 - New Access Road	2 - B1216 Ferry Road East	3 - B1216 Ferry Road West	
08:00 - 08:15	From	1 - New Access Road	0	8	2
		2 - B1216 Ferry Road East	6	0	14
		3 - B1216 Ferry Road West	0	4	0

Heavy Vehicle Percentages

		To			
		1 - New Access Road	2 - B1216 Ferry Road East	3 - B1216 Ferry Road West	
08:15 - 08:30	From	1 - New Access Road	0	19	3
		2 - B1216 Ferry Road East	5	0	10
		3 - B1216 Ferry Road West	1	5	0

Heavy Vehicle Percentages

		To			
		1 - New Access Road	2 - B1216 Ferry Road East	3 - B1216 Ferry Road West	
08:30 - 08:45	From	1 - New Access Road	0	8	2
		2 - B1216 Ferry Road East	6	0	24
		3 - B1216 Ferry Road West	2	12	0

Heavy Vehicle Percentages

		To			
		1 - New Access Road	2 - B1216 Ferry Road East	3 - B1216 Ferry Road West	
08:45 - 09:00	From	1 - New Access Road	0	8	3
		2 - B1216 Ferry Road East	9	0	17
		3 - B1216 Ferry Road West	2	8	0

Results

Results Summary for whole modelled period

Arm	Max RFC	Max Delay (s)	Max Queue (PCU)	Max LOS	Average Demand (PCU/hr)	Total Junction Arrivals (PCU)
1 - New Access Road	0.05	2.78	0.1	A	47	47
2 - B1216 Ferry Road East	0.07	2.67	0.1	A	88	88
3 - B1216 Ferry Road West	0.03	2.53	0.0	A	35	35

Main Results for each time segment

08:00 - 08:15

Arm	Total Demand (PCU/hr)	Junction Arrivals (PCU)	Circulating flow (PCU/hr)	Capacity (PCU/hr)	RFC	Throughput (PCU/hr)	Throughput (exit side) (PCU/hr)	Start queue (PCU)	End queue (PCU)	Delay (s)	Unsignalised level of service
1 - New Access Road	34	9	13	1581	0.022	34	67	0.0	0.0	2.483	A
2 - B1216 Ferry Road East	77	19	7	1597	0.048	77	40	0.0	0.1	2.542	A
3 - B1216 Ferry Road West	17	4	63	1600	0.011	17	21	0.0	0.0	2.342	A

08:15 - 08:30

Arm	Total Demand (PCU/hr)	Junction Arrivals (PCU)	Circulating flow (PCU/hr)	Capacity (PCU/hr)	RFC	Throughput (PCU/hr)	Throughput (exit side) (PCU/hr)	Start queue (PCU)	End queue (PCU)	Delay (s)	Unsignalised level of service
1 - New Access Road	85	21	15	1579	0.054	85	74	0.0	0.1	2.779	A
2 - B1216 Ferry Road East	74	19	17	1591	0.047	74	83	0.1	0.1	2.509	A
3 - B1216 Ferry Road West	26	7	63	1600	0.016	26	28	0.0	0.0	2.361	A

08:30 - 08:45

Arm	Total Demand (PCU/hr)	Junction Arrivals (PCU)	Circulating flow (PCU/hr)	Capacity (PCU/hr)	RFC	Throughput (PCU/hr)	Throughput (exit side) (PCU/hr)	Start queue (PCU)	End queue (PCU)	Delay (s)	Unsignalised level of service
1 - New Access Road	34	9	37	1566	0.022	34	78	0.1	0.0	2.509	A
2 - B1216 Ferry Road East	88	22	7	1597	0.055	88	64	0.1	0.1	2.637	A
3 - B1216 Ferry Road West	52	13	63	1600	0.033	52	32	0.0	0.0	2.532	A

08:45 - 09:00

Arm	Total Demand (PCU/hr)	Junction Arrivals (PCU)	Circulating flow (PCU/hr)	Capacity (PCU/hr)	RFC	Throughput (PCU/hr)	Throughput (exit side) (PCU/hr)	Start queue (PCU)	End queue (PCU)	Delay (s)	Unsignalised level of service
1 - New Access Road	34	9	25	1573	0.022	34	114	0.0	0.0	2.500	A
2 - B1216 Ferry Road East	113	28	7	1597	0.071	113	52	0.1	0.1	2.671	A
3 - B1216 Ferry Road West	43	11	96	1579	0.027	43	24	0.0	0.0	2.471	A

2028 + Committed Development No Development Traffic, PM

Data Errors and Warnings

No errors or warnings

Junction Network

Junctions

Junction	Name	Junction type	Use circulating lanes	Arm order	Junction Delay (s)	Junction LOS
1	untitled	Standard Roundabout		1, 2, 3	2.60	A

Junction Network Options

Driving side	Lighting
Left	Normal/unknown

Traffic Demand

Demand Set Details

ID	Scenario name	Time Period name	Traffic profile type	Start time (HH:mm)	Finish time (HH:mm)	Time period length (min)	Time segment length (min)	Run automatically
D12	2028 + Committed Development No Development Traffic	PM	DIRECT	16:00	17:00	60	15	✓

Vehicle mix varies over time	Vehicle mix varies over turn	Vehicle mix varies over entry	Vehicle mix source	PCU Factor for a HV (PCU)	O-D data varies over time
✓	✓	✓	HV Percentages	2.00	✓

Demand overview (Traffic)

Arm	Linked arm	Profile type	Use O-D data	Scaling Factor (%)
1 - New Access Road		DIRECT	✓	100.000
2 - B1216 Ferry Road East		DIRECT	✓	100.000
3 - B1216 Ferry Road West		DIRECT	✓	100.000

Origin-Destination Data

Demand (PCU/hr)

		To		
		1 - New Access Road	2 - B1216 Ferry Road East	3 - B1216 Ferry Road West
16:00 - 16:15	From			
	1 - New Access Road	0	42	20
	2 - B1216 Ferry Road East	34	0	35
	3 - B1216 Ferry Road West	34	17	0

Demand (PCU/hr)

		To		
		1 - New Access Road	2 - B1216 Ferry Road East	3 - B1216 Ferry Road West
16:15 - 16:30	From			
	1 - New Access Road	0	58	28
	2 - B1216 Ferry Road East	34	0	18
	3 - B1216 Ferry Road West	15	12	0

Demand (PCU/hr)

		To			
		1 - New Access Road	2 - B1216 Ferry Road East	3 - B1216 Ferry Road West	
16:30 - 16:45	From	1 - New Access Road	0	70	34
		2 - B1216 Ferry Road East	49	0	15
		3 - B1216 Ferry Road West	15	24	0

Demand (PCU/hr)

		To			
		1 - New Access Road	2 - B1216 Ferry Road East	3 - B1216 Ferry Road West	
16:45 - 17:00	From	1 - New Access Road	0	63	30
		2 - B1216 Ferry Road East	73	0	25
		3 - B1216 Ferry Road West	29	17	0

Vehicle Mix

Heavy Vehicle Percentages

		To			
		1 - New Access Road	2 - B1216 Ferry Road East	3 - B1216 Ferry Road West	
16:00 - 16:15	From	1 - New Access Road	0	6	1
		2 - B1216 Ferry Road East	5	0	10
		3 - B1216 Ferry Road West	0	5	0

Heavy Vehicle Percentages

		To			
		1 - New Access Road	2 - B1216 Ferry Road East	3 - B1216 Ferry Road West	
16:15 - 16:30	From	1 - New Access Road	0	8	0
		2 - B1216 Ferry Road East	9	0	5
		3 - B1216 Ferry Road West	0	4	0

Heavy Vehicle Percentages

		To			
		1 - New Access Road	2 - B1216 Ferry Road East	3 - B1216 Ferry Road West	
16:30 - 16:45	From	1 - New Access Road	0	10	1
		2 - B1216 Ferry Road East	9	0	4
		3 - B1216 Ferry Road West	0	8	0

Heavy Vehicle Percentages

		To			
		1 - New Access Road	2 - B1216 Ferry Road East	3 - B1216 Ferry Road West	
16:45 - 17:00	From	1 - New Access Road	0	9	1
		2 - B1216 Ferry Road East	12	0	7
		3 - B1216 Ferry Road West	0	5	0

Results

Results Summary for whole modelled period

Arm	Max RFC	Max Delay (s)	Max Queue (PCU)	Max LOS	Average Demand (PCU/hr)	Total Junction Arrivals (PCU)
1 - New Access Road	0.07	2.62	0.1	A	86	86
2 - B1216 Ferry Road East	0.06	2.68	0.1	A	71	71
3 - B1216 Ferry Road West	0.03	2.40	0.0	A	41	41

Main Results for each time segment

16:00 - 16:15

Arm	Total Demand (PCU/hr)	Junction Arrivals (PCU)	Circulating flow (PCU/hr)	Capacity (PCU/hr)	RFC	Throughput (PCU/hr)	Throughput (exit side) (PCU/hr)	Start queue (PCU)	End queue (PCU)	Delay (s)	Unsignalised level of service
1 - New Access Road	62	16	17	1578	0.039	62	68	0.0	0.0	2.476	A
2 - B1216 Ferry Road East	69	17	20	1589	0.043	69	59	0.0	0.0	2.545	A
3 - B1216 Ferry Road West	51	13	34	1618	0.032	51	55	0.0	0.0	2.334	A

16:15 - 16:30

Arm	Total Demand (PCU/hr)	Junction Arrivals (PCU)	Circulating flow (PCU/hr)	Capacity (PCU/hr)	RFC	Throughput (PCU/hr)	Throughput (exit side) (PCU/hr)	Start queue (PCU)	End queue (PCU)	Delay (s)	Unsignalised level of service
1 - New Access Road	86	22	12	1581	0.054	86	49	0.0	0.1	2.533	A
2 - B1216 Ferry Road East	52	13	28	1584	0.033	52	70	0.0	0.0	2.529	A
3 - B1216 Ferry Road West	27	7	34	1618	0.017	27	46	0.0	0.0	2.303	A

16:30 - 16:45

Arm	Total Demand (PCU/hr)	Junction Arrivals (PCU)	Circulating flow (PCU/hr)	Capacity (PCU/hr)	RFC	Throughput (PCU/hr)	Throughput (exit side) (PCU/hr)	Start queue (PCU)	End queue (PCU)	Delay (s)	Unsignalised level of service
1 - New Access Road	104	26	24	1574	0.066	104	64	0.1	0.1	2.617	A
2 - B1216 Ferry Road East	64	16	34	1580	0.041	64	94	0.0	0.0	2.558	A
3 - B1216 Ferry Road West	39	10	49	1609	0.024	39	49	0.0	0.0	2.402	A

16:45 - 17:00

Arm	Total Demand (PCU/hr)	Junction Arrivals (PCU)	Circulating flow (PCU/hr)	Capacity (PCU/hr)	RFC	Throughput (PCU/hr)	Throughput (exit side) (PCU/hr)	Start queue (PCU)	End queue (PCU)	Delay (s)	Unsignalised level of service
1 - New Access Road	93	23	17	1578	0.059	93	102	0.1	0.1	2.577	A
2 - B1216 Ferry Road East	98	25	30	1583	0.062	98	80	0.0	0.1	2.683	A
3 - B1216 Ferry Road West	46	12	73	1594	0.029	46	55	0.0	0.0	2.367	A

2028 + Committed Development + Development Traffic, AM

Data Errors and Warnings

No errors or warnings

Junction Network

Junctions

Junction	Name	Junction type	Use circulating lanes	Arm order	Junction Delay (s)	Junction LOS
1	untitled	Standard Roundabout		1, 2, 3	2.66	A

Junction Network Options

Driving side	Lighting
Left	Normal/unknown

Traffic Demand

Demand Set Details

ID	Scenario name	Time Period name	Traffic profile type	Start time (HH:mm)	Finish time (HH:mm)	Time period length (min)	Time segment length (min)	Run automatically
D13	2028 + Committed Development + Development Traffic	AM	DIRECT	08:00	09:00	60	15	✓

Vehicle mix varies over time	Vehicle mix varies over turn	Vehicle mix varies over entry	Vehicle mix source	PCU Factor for a HV (PCU)	O-D data varies over time
✓	✓	✓	HV Percentages	2.00	✓

Demand overview (Traffic)

Arm	Linked arm	Profile type	Use O-D data	Scaling Factor (%)
1 - New Access Road		DIRECT	✓	100.000
2 - B1216 Ferry Road East		DIRECT	✓	100.000
3 - B1216 Ferry Road West		DIRECT	✓	100.000

Origin-Destination Data

Demand (PCU/hr)

		To		
		1 - New Access Road	2 - B1216 Ferry Road East	3 - B1216 Ferry Road West
08:00 - 08:15	From			
	1 - New Access Road	0	27	7
	2 - B1216 Ferry Road East	65	0	15
	3 - B1216 Ferry Road West	4	13	0

Demand (PCU/hr)

		To		
		1 - New Access Road	2 - B1216 Ferry Road East	3 - B1216 Ferry Road West
08:15 - 08:30	From			
	1 - New Access Road	0	69	17
	2 - B1216 Ferry Road East	65	0	11
	3 - B1216 Ferry Road West	11	16	0

Demand (PCU/hr)

		To			
		1 - New Access Road	2 - B1216 Ferry Road East	3 - B1216 Ferry Road West	
08:30 - 08:45	From	1 - New Access Road	0	27	7
		2 - B1216 Ferry Road East	65	0	26
		3 - B1216 Ferry Road West	15	38	0

Demand (PCU/hr)

		To			
		1 - New Access Road	2 - B1216 Ferry Road East	3 - B1216 Ferry Road West	
08:45 - 09:00	From	1 - New Access Road	0	27	7
		2 - B1216 Ferry Road East	99	0	18
		3 - B1216 Ferry Road West	18	26	0

Vehicle Mix

Heavy Vehicle Percentages

		To			
		1 - New Access Road	2 - B1216 Ferry Road East	3 - B1216 Ferry Road West	
08:00 - 08:15	From	1 - New Access Road	0	7	2
		2 - B1216 Ferry Road East	5	0	12
		3 - B1216 Ferry Road West	0	4	0

Heavy Vehicle Percentages

		To			
		1 - New Access Road	2 - B1216 Ferry Road East	3 - B1216 Ferry Road West	
08:15 - 08:30	From	1 - New Access Road	0	19	3
		2 - B1216 Ferry Road East	5	0	9
		3 - B1216 Ferry Road West	1	5	0

Heavy Vehicle Percentages

		To			
		1 - New Access Road	2 - B1216 Ferry Road East	3 - B1216 Ferry Road West	
08:30 - 08:45	From	1 - New Access Road	0	7	2
		2 - B1216 Ferry Road East	5	0	22
		3 - B1216 Ferry Road West	2	12	0

Heavy Vehicle Percentages

		To			
		1 - New Access Road	2 - B1216 Ferry Road East	3 - B1216 Ferry Road West	
08:45 - 09:00	From	1 - New Access Road	0	7	3
		2 - B1216 Ferry Road East	8	0	15
		3 - B1216 Ferry Road West	2	8	0

Results

Results Summary for whole modelled period

Arm	Max RFC	Max Delay (s)	Max Queue (PCU)	Max LOS	Average Demand (PCU/hr)	Total Junction Arrivals (PCU)
1 - New Access Road	0.05	2.78	0.1	A	47	47
2 - B1216 Ferry Road East	0.07	2.65	0.1	A	91	91
3 - B1216 Ferry Road West	0.03	2.54	0.0	A	35	35

Main Results for each time segment

08:00 - 08:15

Arm	Total Demand (PCU/hr)	Junction Arrivals (PCU)	Circulating flow (PCU/hr)	Capacity (PCU/hr)	RFC	Throughput (PCU/hr)	Throughput (exit side) (PCU/hr)	Start queue (PCU)	End queue (PCU)	Delay (s)	Unsignalised level of service
1 - New Access Road	34	9	13	1581	0.022	34	69	0.0	0.0	2.465	A
2 - B1216 Ferry Road East	80	20	7	1597	0.050	80	40	0.0	0.1	2.521	A
3 - B1216 Ferry Road West	17	4	65	1599	0.011	17	22	0.0	0.0	2.344	A

08:15 - 08:30

Arm	Total Demand (PCU/hr)	Junction Arrivals (PCU)	Circulating flow (PCU/hr)	Capacity (PCU/hr)	RFC	Throughput (PCU/hr)	Throughput (exit side) (PCU/hr)	Start queue (PCU)	End queue (PCU)	Delay (s)	Unsignalised level of service
1 - New Access Road	86	22	16	1579	0.054	86	76	0.0	0.1	2.783	A
2 - B1216 Ferry Road East	76	19	17	1591	0.048	76	85	0.1	0.1	2.510	A
3 - B1216 Ferry Road West	27	7	65	1598	0.017	27	28	0.0	0.0	2.366	A

08:30 - 08:45

Arm	Total Demand (PCU/hr)	Junction Arrivals (PCU)	Circulating flow (PCU/hr)	Capacity (PCU/hr)	RFC	Throughput (PCU/hr)	Throughput (exit side) (PCU/hr)	Start queue (PCU)	End queue (PCU)	Delay (s)	Unsignalised level of service
1 - New Access Road	34	9	38	1565	0.022	34	80	0.1	0.0	2.491	A
2 - B1216 Ferry Road East	91	23	7	1597	0.057	91	65	0.1	0.1	2.613	A
3 - B1216 Ferry Road West	53	13	65	1598	0.033	53	33	0.0	0.0	2.537	A

08:45 - 09:00

Arm	Total Demand (PCU/hr)	Junction Arrivals (PCU)	Circulating flow (PCU/hr)	Capacity (PCU/hr)	RFC	Throughput (PCU/hr)	Throughput (exit side) (PCU/hr)	Start queue (PCU)	End queue (PCU)	Delay (s)	Unsignalised level of service
1 - New Access Road	34	9	26	1573	0.022	34	117	0.0	0.0	2.485	A
2 - B1216 Ferry Road East	117	29	7	1597	0.073	117	53	0.1	0.1	2.651	A
3 - B1216 Ferry Road West	44	11	99	1577	0.028	44	25	0.0	0.0	2.477	A

2028 + Committed Development + Development Traffic, PM

Data Errors and Warnings

No errors or warnings

Junction Network

Junctions

Junction	Name	Junction type	Use circulating lanes	Arm order	Junction Delay (s)	Junction LOS
1	untitled	Standard Roundabout		1, 2, 3	2.59	A

Junction Network Options

Driving side	Lighting
Left	Normal/unknown

Traffic Demand

Demand Set Details

ID	Scenario name	Time Period name	Traffic profile type	Start time (HH:mm)	Finish time (HH:mm)	Time period length (min)	Time segment length (min)	Run automatically
D14	2028 + Committed Development + Development Traffic	PM	DIRECT	16:00	17:00	60	15	✓

Vehicle mix varies over time	Vehicle mix varies over turn	Vehicle mix varies over entry	Vehicle mix source	PCU Factor for a HV (PCU)	O-D data varies over time
✓	✓	✓	HV Percentages	2.00	✓

Demand overview (Traffic)

Arm	Linked arm	Profile type	Use O-D data	Scaling Factor (%)
1 - New Access Road		DIRECT	✓	100.000
2 - B1216 Ferry Road East		DIRECT	✓	100.000
3 - B1216 Ferry Road West		DIRECT	✓	100.000

Origin-Destination Data

Demand (PCU/hr)

		To		
		1 - New Access Road	2 - B1216 Ferry Road East	3 - B1216 Ferry Road West
16:00 - 16:15	From			
	1 - New Access Road	0	42	20
	2 - B1216 Ferry Road East	35	0	35
	3 - B1216 Ferry Road West	35	17	0

Demand (PCU/hr)

		To		
		1 - New Access Road	2 - B1216 Ferry Road East	3 - B1216 Ferry Road West
16:15 - 16:30	From			
	1 - New Access Road	0	58	28
	2 - B1216 Ferry Road East	35	0	18
	3 - B1216 Ferry Road West	15	12	0

Demand (PCU/hr)

		To		
		1 - New Access Road	2 - B1216 Ferry Road East	3 - B1216 Ferry Road West
16:30 - 16:45	From			
	1 - New Access Road	0	70	34
	2 - B1216 Ferry Road East	50	0	15
	3 - B1216 Ferry Road West	15	24	0

Demand (PCU/hr)

		To		
		1 - New Access Road	2 - B1216 Ferry Road East	3 - B1216 Ferry Road West
16:45 - 17:00	From			
	1 - New Access Road	0	63	30
	2 - B1216 Ferry Road East	74	0	25
	3 - B1216 Ferry Road West	30	17	0

Vehicle Mix

Heavy Vehicle Percentages

		To		
		1 - New Access Road	2 - B1216 Ferry Road East	3 - B1216 Ferry Road West
16:00 - 16:15	From			
	1 - New Access Road	0	6	1
	2 - B1216 Ferry Road East	5	0	10
	3 - B1216 Ferry Road West	0	5	0

Heavy Vehicle Percentages

		To		
		1 - New Access Road	2 - B1216 Ferry Road East	3 - B1216 Ferry Road West
16:15 - 16:30	From			
	1 - New Access Road	0	8	0
	2 - B1216 Ferry Road East	9	0	5
	3 - B1216 Ferry Road West	0	4	0

Heavy Vehicle Percentages

		To		
		1 - New Access Road	2 - B1216 Ferry Road East	3 - B1216 Ferry Road West
16:30 - 16:45	From			
	1 - New Access Road	0	10	1
	2 - B1216 Ferry Road East	8	0	4
	3 - B1216 Ferry Road West	0	8	0

Heavy Vehicle Percentages

		To		
		1 - New Access Road	2 - B1216 Ferry Road East	3 - B1216 Ferry Road West
16:45 - 17:00	From			
	1 - New Access Road	0	9	1
	2 - B1216 Ferry Road East	11	0	7
	3 - B1216 Ferry Road West	0	5	0

Results

Results Summary for whole modelled period

Arm	Max RFC	Max Delay (s)	Max Queue (PCU)	Max LOS	Average Demand (PCU/hr)	Total Junction Arrivals (PCU)
1 - New Access Road	0.07	2.62	0.1	A	86	86
2 - B1216 Ferry Road East	0.06	2.67	0.1	A	72	72
3 - B1216 Ferry Road West	0.03	2.40	0.0	A	41	41

Main Results for each time segment

16:00 - 16:15

Arm	Total Demand (PCU/hr)	Junction Arrivals (PCU)	Circulating flow (PCU/hr)	Capacity (PCU/hr)	RFC	Throughput (PCU/hr)	Throughput (exit side) (PCU/hr)	Start queue (PCU)	End queue (PCU)	Delay (s)	Unsignalised level of service
1 - New Access Road	62	16	17	1578	0.039	62	70	0.0	0.0	2.476	A
2 - B1216 Ferry Road East	70	18	20	1589	0.044	70	59	0.0	0.0	2.546	A
3 - B1216 Ferry Road West	52	13	35	1617	0.032	52	55	0.0	0.0	2.335	A

16:15 - 16:30

Arm	Total Demand (PCU/hr)	Junction Arrivals (PCU)	Circulating flow (PCU/hr)	Capacity (PCU/hr)	RFC	Throughput (PCU/hr)	Throughput (exit side) (PCU/hr)	Start queue (PCU)	End queue (PCU)	Delay (s)	Unsignalised level of service
1 - New Access Road	86	22	12	1581	0.054	86	50	0.0	0.1	2.533	A
2 - B1216 Ferry Road East	53	13	28	1584	0.033	53	70	0.0	0.0	2.530	A
3 - B1216 Ferry Road West	27	7	35	1617	0.017	27	46	0.0	0.0	2.304	A

16:30 - 16:45

Arm	Total Demand (PCU/hr)	Junction Arrivals (PCU)	Circulating flow (PCU/hr)	Capacity (PCU/hr)	RFC	Throughput (PCU/hr)	Throughput (exit side) (PCU/hr)	Start queue (PCU)	End queue (PCU)	Delay (s)	Unsignalised level of service
1 - New Access Road	104	26	24	1574	0.066	104	65	0.1	0.1	2.617	A
2 - B1216 Ferry Road East	65	16	34	1580	0.041	65	94	0.0	0.0	2.543	A
3 - B1216 Ferry Road West	39	10	50	1608	0.024	39	49	0.0	0.0	2.403	A

16:45 - 17:00

Arm	Total Demand (PCU/hr)	Junction Arrivals (PCU)	Circulating flow (PCU/hr)	Capacity (PCU/hr)	RFC	Throughput (PCU/hr)	Throughput (exit side) (PCU/hr)	Start queue (PCU)	End queue (PCU)	Delay (s)	Unsignalised level of service
1 - New Access Road	93	23	17	1578	0.059	93	104	0.1	0.1	2.575	A
2 - B1216 Ferry Road East	99	25	30	1583	0.063	99	80	0.0	0.1	2.667	A
3 - B1216 Ferry Road West	47	12	74	1593	0.030	47	55	0.0	0.0	2.369	A

2038 + Committed Development + Development (Sensitivity Test), AM

Data Errors and Warnings

No errors or warnings

Junction Network

Junctions

Junction	Name	Junction type	Use circulating lanes	Arm order	Junction Delay (s)	Junction LOS
1	untitled	Standard Roundabout		1, 2, 3	2.65	A

Junction Network Options

Driving side	Lighting
Left	Normal/unknown

Traffic Demand

Demand Set Details

ID	Scenario name	Time Period name	Traffic profile type	Start time (HH:mm)	Finish time (HH:mm)	Time period length (min)	Time segment length (min)	Run automatically
D15	2038 + Committed Development + Development (Sensitivity Test)	AM	DIRECT	08:00	09:00	60	15	✓

Vehicle mix varies over time	Vehicle mix varies over turn	Vehicle mix varies over entry	Vehicle mix source	PCU Factor for a HV (PCU)	O-D data varies over time
✓	✓	✓	HV Percentages	2.00	✓

Demand overview (Traffic)

Arm	Linked arm	Profile type	Use O-D data	Scaling Factor (%)
1 - New Access Road		DIRECT	✓	100.000
2 - B1216 Ferry Road East		DIRECT	✓	100.000
3 - B1216 Ferry Road West		DIRECT	✓	100.000

Origin-Destination Data

Demand (PCU/hr)

		To		
		1 - New Access Road	2 - B1216 Ferry Road East	3 - B1216 Ferry Road West
08:00 - 08:15	From			
	1 - New Access Road	0	29	7
	2 - B1216 Ferry Road East	73	0	17
	3 - B1216 Ferry Road West	4	14	0

Demand (PCU/hr)

		To		
		1 - New Access Road	2 - B1216 Ferry Road East	3 - B1216 Ferry Road West
08:15 - 08:30	From			
	1 - New Access Road	0	73	17
	2 - B1216 Ferry Road East	73	0	13
	3 - B1216 Ferry Road West	11	17	0

Demand (PCU/hr)

		To			
		1 - New Access Road	2 - B1216 Ferry Road East	3 - B1216 Ferry Road West	
08:30 - 08:45	From	1 - New Access Road	0	29	7
		2 - B1216 Ferry Road East	73	0	31
		3 - B1216 Ferry Road West	15	41	0

Demand (PCU/hr)

		To			
		1 - New Access Road	2 - B1216 Ferry Road East	3 - B1216 Ferry Road West	
08:45 - 09:00	From	1 - New Access Road	0	29	7
		2 - B1216 Ferry Road East	111	0	22
		3 - B1216 Ferry Road West	18	28	0

Vehicle Mix

Heavy Vehicle Percentages

		To			
		1 - New Access Road	2 - B1216 Ferry Road East	3 - B1216 Ferry Road West	
08:00 - 08:15	From	1 - New Access Road	0	7	3
		2 - B1216 Ferry Road East	5	0	9
		3 - B1216 Ferry Road West	0	4	0

Heavy Vehicle Percentages

		To			
		1 - New Access Road	2 - B1216 Ferry Road East	3 - B1216 Ferry Road West	
08:15 - 08:30	From	1 - New Access Road	0	17	3
		2 - B1216 Ferry Road East	4	0	7
		3 - B1216 Ferry Road West	1	4	0

Heavy Vehicle Percentages

		To			
		1 - New Access Road	2 - B1216 Ferry Road East	3 - B1216 Ferry Road West	
08:30 - 08:45	From	1 - New Access Road	0	7	2
		2 - B1216 Ferry Road East	5	0	15
		3 - B1216 Ferry Road West	2	10	0

Heavy Vehicle Percentages

		To			
		1 - New Access Road	2 - B1216 Ferry Road East	3 - B1216 Ferry Road West	
08:45 - 09:00	From	1 - New Access Road	0	7	3
		2 - B1216 Ferry Road East	7	0	11
		3 - B1216 Ferry Road West	2	7	0

Results

Results Summary for whole modelled period

Arm	Max RFC	Max Delay (s)	Max Queue (PCU)	Max LOS	Average Demand (PCU/hr)	Total Junction Arrivals (PCU)
1 - New Access Road	0.06	2.76	0.1	A	50	50
2 - B1216 Ferry Road East	0.08	2.65	0.1	A	103	103
3 - B1216 Ferry Road West	0.04	2.52	0.0	A	37	37

Main Results for each time segment

08:00 - 08:15

Arm	Total Demand (PCU/hr)	Junction Arrivals (PCU)	Circulating flow (PCU/hr)	Capacity (PCU/hr)	RFC	Throughput (PCU/hr)	Throughput (exit side) (PCU/hr)	Start queue (PCU)	End queue (PCU)	Delay (s)	Unsignalised level of service
1 - New Access Road	36	9	14	1580	0.023	36	77	0.0	0.0	2.475	A
2 - B1216 Ferry Road East	90	23	7	1597	0.056	90	43	0.0	0.1	2.525	A
3 - B1216 Ferry Road West	18	5	73	1594	0.011	18	24	0.0	0.0	2.354	A

08:15 - 08:30

Arm	Total Demand (PCU/hr)	Junction Arrivals (PCU)	Circulating flow (PCU/hr)	Capacity (PCU/hr)	RFC	Throughput (PCU/hr)	Throughput (exit side) (PCU/hr)	Start queue (PCU)	End queue (PCU)	Delay (s)	Unsignalised level of service
1 - New Access Road	90	23	17	1578	0.057	90	84	0.0	0.1	2.758	A
2 - B1216 Ferry Road East	86	22	17	1591	0.054	86	90	0.1	0.1	2.498	A
3 - B1216 Ferry Road West	28	7	73	1593	0.018	28	30	0.0	0.0	2.363	A

08:30 - 08:45

Arm	Total Demand (PCU/hr)	Junction Arrivals (PCU)	Circulating flow (PCU/hr)	Capacity (PCU/hr)	RFC	Throughput (PCU/hr)	Throughput (exit side) (PCU/hr)	Start queue (PCU)	End queue (PCU)	Delay (s)	Unsignalised level of service
1 - New Access Road	36	9	41	1564	0.023	36	88	0.1	0.0	2.499	A
2 - B1216 Ferry Road East	104	26	7	1597	0.065	104	70	0.1	0.1	2.598	A
3 - B1216 Ferry Road West	56	14	73	1593	0.035	56	38	0.0	0.0	2.521	A

08:45 - 09:00

Arm	Total Demand (PCU/hr)	Junction Arrivals (PCU)	Circulating flow (PCU/hr)	Capacity (PCU/hr)	RFC	Throughput (PCU/hr)	Throughput (exit side) (PCU/hr)	Start queue (PCU)	End queue (PCU)	Delay (s)	Unsignalised level of service
1 - New Access Road	36	9	28	1571	0.023	36	129	0.0	0.0	2.491	A
2 - B1216 Ferry Road East	133	33	7	1597	0.083	133	57	0.1	0.1	2.646	A
3 - B1216 Ferry Road West	46	12	111	1570	0.029	46	29	0.0	0.0	2.482	A

2038 + Committed Development + Development (Sensitivity Test), PM

Data Errors and Warnings

No errors or warnings

Junction Network

Junctions

Junction	Name	Junction type	Use circulating lanes	Arm order	Junction Delay (s)	Junction LOS
1	untitled	Standard Roundabout		1, 2, 3	2.59	A

Junction Network Options

Driving side	Lighting
Left	Normal/unknown

Traffic Demand

Demand Set Details

ID	Scenario name	Time Period name	Traffic profile type	Start time (HH:mm)	Finish time (HH:mm)	Time period length (min)	Time segment length (min)	Run automatically
D16	2038 + Committed Development + Development (Sensitivity Test)	PM	DIRECT	16:00	17:00	60	15	✓

Vehicle mix varies over time	Vehicle mix varies over turn	Vehicle mix varies over entry	Vehicle mix source	PCU Factor for a HV (PCU)	O-D data varies over time
✓	✓	✓	HV Percentages	2.00	✓

Demand overview (Traffic)

Arm	Linked arm	Profile type	Use O-D data	Scaling Factor (%)
1 - New Access Road		DIRECT	✓	100.000
2 - B1216 Ferry Road East		DIRECT	✓	100.000
3 - B1216 Ferry Road West		DIRECT	✓	100.000

Origin-Destination Data

Demand (PCU/hr)

16:00 - 16:15

		To		
		1 - New Access Road	2 - B1216 Ferry Road East	3 - B1216 Ferry Road West
From	1 - New Access Road	0	42	20
	2 - B1216 Ferry Road East	37	0	35
	3 - B1216 Ferry Road West	38	17	0

Demand (PCU/hr)

16:15 - 16:30

		To		
		1 - New Access Road	2 - B1216 Ferry Road East	3 - B1216 Ferry Road West
From	1 - New Access Road	0	58	28
	2 - B1216 Ferry Road East	37	0	18
	3 - B1216 Ferry Road West	16	12	0

Demand (PCU/hr)

		To			
		1 - New Access Road	2 - B1216 Ferry Road East	3 - B1216 Ferry Road West	
16:30 - 16:45	From	1 - New Access Road	0	70	34
		2 - B1216 Ferry Road East	53	0	15
		3 - B1216 Ferry Road West	16	24	0

Demand (PCU/hr)

		To			
		1 - New Access Road	2 - B1216 Ferry Road East	3 - B1216 Ferry Road West	
16:45 - 17:00	From	1 - New Access Road	0	63	30
		2 - B1216 Ferry Road East	78	0	25
		3 - B1216 Ferry Road West	33	17	0

Vehicle Mix

Heavy Vehicle Percentages

		To			
		1 - New Access Road	2 - B1216 Ferry Road East	3 - B1216 Ferry Road West	
16:00 - 16:15	From	1 - New Access Road	0	6	1
		2 - B1216 Ferry Road East	5	0	10
		3 - B1216 Ferry Road West	0	5	0

Heavy Vehicle Percentages

		To			
		1 - New Access Road	2 - B1216 Ferry Road East	3 - B1216 Ferry Road West	
16:15 - 16:30	From	1 - New Access Road	0	8	0
		2 - B1216 Ferry Road East	8	0	5
		3 - B1216 Ferry Road West	0	4	0

Heavy Vehicle Percentages

		To			
		1 - New Access Road	2 - B1216 Ferry Road East	3 - B1216 Ferry Road West	
16:30 - 16:45	From	1 - New Access Road	0	10	1
		2 - B1216 Ferry Road East	7	0	4
		3 - B1216 Ferry Road West	0	8	0

Heavy Vehicle Percentages

		To			
		1 - New Access Road	2 - B1216 Ferry Road East	3 - B1216 Ferry Road West	
16:45 - 17:00	From	1 - New Access Road	0	9	1
		2 - B1216 Ferry Road East	10	0	7
		3 - B1216 Ferry Road West	0	5	0

Results

Results Summary for whole modelled period

Arm	Max RFC	Max Delay (s)	Max Queue (PCU)	Max LOS	Average Demand (PCU/hr)	Total Junction Arrivals (PCU)
1 - New Access Road	0.07	2.62	0.1	A	86	86
2 - B1216 Ferry Road East	0.07	2.66	0.1	A	75	75
3 - B1216 Ferry Road West	0.03	2.40	0.0	A	43	43

Main Results for each time segment

16:00 - 16:15

Arm	Total Demand (PCU/hr)	Junction Arrivals (PCU)	Circulating flow (PCU/hr)	Capacity (PCU/hr)	RFC	Throughput (PCU/hr)	Throughput (exit side) (PCU/hr)	Start queue (PCU)	End queue (PCU)	Delay (s)	Unsignalised level of service
1 - New Access Road	62	16	17	1578	0.039	62	75	0.0	0.0	2.476	A
2 - B1216 Ferry Road East	72	18	20	1589	0.045	72	59	0.0	0.1	2.547	A
3 - B1216 Ferry Road West	55	14	37	1616	0.034	55	55	0.0	0.0	2.340	A

16:15 - 16:30

Arm	Total Demand (PCU/hr)	Junction Arrivals (PCU)	Circulating flow (PCU/hr)	Capacity (PCU/hr)	RFC	Throughput (PCU/hr)	Throughput (exit side) (PCU/hr)	Start queue (PCU)	End queue (PCU)	Delay (s)	Unsignalised level of service
1 - New Access Road	86	22	12	1581	0.054	86	53	0.0	0.1	2.533	A
2 - B1216 Ferry Road East	55	14	28	1584	0.035	55	70	0.1	0.0	2.521	A
3 - B1216 Ferry Road West	28	7	37	1616	0.017	28	46	0.0	0.0	2.304	A

16:30 - 16:45

Arm	Total Demand (PCU/hr)	Junction Arrivals (PCU)	Circulating flow (PCU/hr)	Capacity (PCU/hr)	RFC	Throughput (PCU/hr)	Throughput (exit side) (PCU/hr)	Start queue (PCU)	End queue (PCU)	Delay (s)	Unsignalised level of service
1 - New Access Road	104	26	24	1574	0.066	104	69	0.1	0.1	2.617	A
2 - B1216 Ferry Road East	68	17	34	1580	0.043	68	94	0.0	0.0	2.530	A
3 - B1216 Ferry Road West	40	10	53	1606	0.025	40	49	0.0	0.0	2.405	A

16:45 - 17:00

Arm	Total Demand (PCU/hr)	Junction Arrivals (PCU)	Circulating flow (PCU/hr)	Capacity (PCU/hr)	RFC	Throughput (PCU/hr)	Throughput (exit side) (PCU/hr)	Start queue (PCU)	End queue (PCU)	Delay (s)	Unsignalised level of service
1 - New Access Road	93	23	17	1578	0.059	93	111	0.1	0.1	2.577	A
2 - B1216 Ferry Road East	103	26	30	1583	0.065	103	80	0.0	0.1	2.657	A
3 - B1216 Ferry Road West	50	13	78	1590	0.031	50	55	0.0	0.0	2.375	A

Natalie Maynard
Buro Happold Limited
17 Newman Street
London
W1T 1PD
UK



APPENDIX C FRAMEWORK TRAVEL PLAN

Date: May 2022

North Lincolnshire Green Energy Park

Operational Workplace Travel Plan

0046658-TP-REP-002

0046658

27 May 2022

Revision P1

Revision	Description	Issued by	Date	Checked
P0	Issued for DCO submission	NG	25/05/2022	NM
P1	Re-Issued for DCO submission	JW	27/05/2022	NM



This report has been prepared for the sole benefit, use and information of North Lincolnshire Green Energy Park Ltd for the purposes set out in the report or instructions commissioning it. The liability of Buro Happold Limited in respect of the information contained in the report will not extend to any third party.

author **Natalie Maynard**



date **27/05/2022**



approved **Natalie Maynard**



signature



date **27/05/2022**



Contents

1	Introduction	7
1.1	Background	7
1.2	General Strategy	9
2	Planning Policy and Guidance	12
2.1	National Networks National Policy Statement (DfT, 2014)	12
2.2	National Planning Policy Framework (NPPF 2021)	12
2.3	Planning Practice Guidance (PPG): Travel Plans (March 2014)	13
2.4	North Lincolnshire Local Plan (2003)	13
2.5	North Lincolnshire Local Development Framework – Core Strategy (2011)	14
2.6	Emerging North Lincolnshire Local Plan (2022 / 2023)	14
3	Benefits and Objectives of this Travel Plan	16
4	Transport Accessibility	18
4.1	Highway Access	18
4.2	Walking and Cycling	19
4.3	Public Transport	23
4.4	Access Provision for the Mobility Impaired	25
5	Travel Plan Management	27
5.1	Travel Plan Co-ordinator	27
5.2	Securing the Travel Plan and Funding	28
6	Travel Survey and Mode Split Targets	29
6.1	Site Users	29
6.2	Preliminary Mode Split	30
6.3	Preliminary Targets	31
6.4	Travel Survey	32
7	Travel Plan Initiatives and Measures	33
7.2	Travel Information Pack	33
7.3	Measures to Promote Walking and Cycling	34

7.4	Measures to Promote Public Transport	36
7.5	Measures to Promote Car Sharing	37
7.6	Electric Vehicle Parking Spaces/Charging Points	37
8	Monitoring and Review	39
9	Action Plan	41

Table of Tables

Table 4.1 – Bus Routes and Service Frequencies	23
Table 4.2 – Train Frequencies at Scunthorpe and Althorpe Stations	25
Table 6.1: The Project – Total Number of Employees	29
Table 6.2: Mode Split of Travel	30
Table 6.3: The Project – Employee Trips by Mode	31
Table 6.4 Preliminary Targets for Employees at the Project	32
Table 7.1 Proposed Cycle Parking at the Project	34
Table 9.1 Interim Action Plan	41

Table of Figures

Figure 1.1 – Project Location Plan	9
Figure 4.1 – Local Highway Network	18
Figure 4.2 - Pedestrian and Cycle Infrastructure in the vicinity of the Project	20
Figure 4.3 – Walking Isochrones	21
Figure 4.4 -Cycling Isochrones	22
Figure 6.1 -The Project – Number of Employees through the day	30

1 Introduction

1.1 Background

- 1.1.1 Buro Happold have prepared this Workplace Travel Plan for North Lincolnshire Green Energy Park Limited ('the Applicant') in relation to the proposed North Lincolnshire Green Energy Park (NLGEP) ('the Project') in Flixborough, Scunthorpe, North Lincolnshire.
- 1.1.2 This Workplace Travel Plan ('Travel Plan') relates to workers / employees at the Project during the operational phase only.
- 1.1.3 The proposals comprise a Nationally Significant Infrastructure Project (NSIP), which requires a Development Consent Order (DCO) application to be submitted for approval by the Planning Inspectorate (PINS) on behalf of the Secretary of State.
- 1.1.4 The North Lincolnshire Green Energy Park (NLGEP) ('the Project'), located at Flixborough, North Lincolnshire, is a Nationally Significant Infrastructure Project (NSIP) with an Energy Recovery Facility (ERF) capable of converting up to 760,000 tonnes of non-recyclable waste into 95 MW of electricity at its heart and a carbon capture, utilisation and storage (CCUS) facility which will treat the excess gasses released from the ERF to remove and store carbon dioxide (CO₂) prior to emission into the atmosphere.
- 1.1.5 The NSIP incorporates a switchyard, to ensure that the power created can be exported to the National Grid or to local businesses, and a water treatment facility, to take water from the mains supply or recycled process water to remove impurities and make it suitable for use in the boilers, the CCUS facility, concrete block manufacture, hydrogen production and the maintenance of the water levels in the wetland area.
- 1.1.6 The Project will include the following Associated Development to support the operation of the NSIP:
- a bottom ash and flue gas residue handling and treatment facility (RHTF)
 - a concrete block manufacturing facility (CBMF)
 - a plastic recycling facility (PRF)
 - a hydrogen production and storage facility
 - an electric vehicle (EV) and hydrogen (H₂) refuelling station
 - battery storage

- a hydrogen and natural gas above ground installation (AGI)
- a new access road and parking
- a gatehouse and visitor centre with elevated walkway
- railway reinstatement works including, sidings at Dragonby, reinstatement and safety improvements to the 6km private railway spur, and the construction of a new railhead with sidings south of Flixborough Wharf
- a northern and southern district heating and private wire network (DHPWN)
- habitat creation, landscaping and ecological mitigation, including green infrastructure and 65-acre wetland area
- new public rights of way and cycle ways including footbridges
- Sustainable Drainage Systems (SuDS) and flood defence, and
- utility constructions and diversions

1.1.7 The Project will also include development in connection with the above works such as security gates, fencing, boundary treatment, lighting, hard and soft landscaping, surface and foul water treatment and drainage systems and CCTV.

1.1.8 The limits of the land covered by the DCO ('the Order Limits') is shown on Figure 1.1. The land within the Order Limits is known as the 'Application Land'. Figure 1.1 also shows the main buildings of the Project located north of the B1216 Ferry Road West (collectively known as 'the Project' including the ERF; carbon capture, utilisation and storage facility; bottom ash and flue gas residue handling and treatment facility; concrete block manufacturing facility; plastic recycling facility; hydrogen production and storage facility; electric vehicle (EV) and hydrogen (H₂) refuelling station; battery storage and hydrogen and natural gas above ground installations).

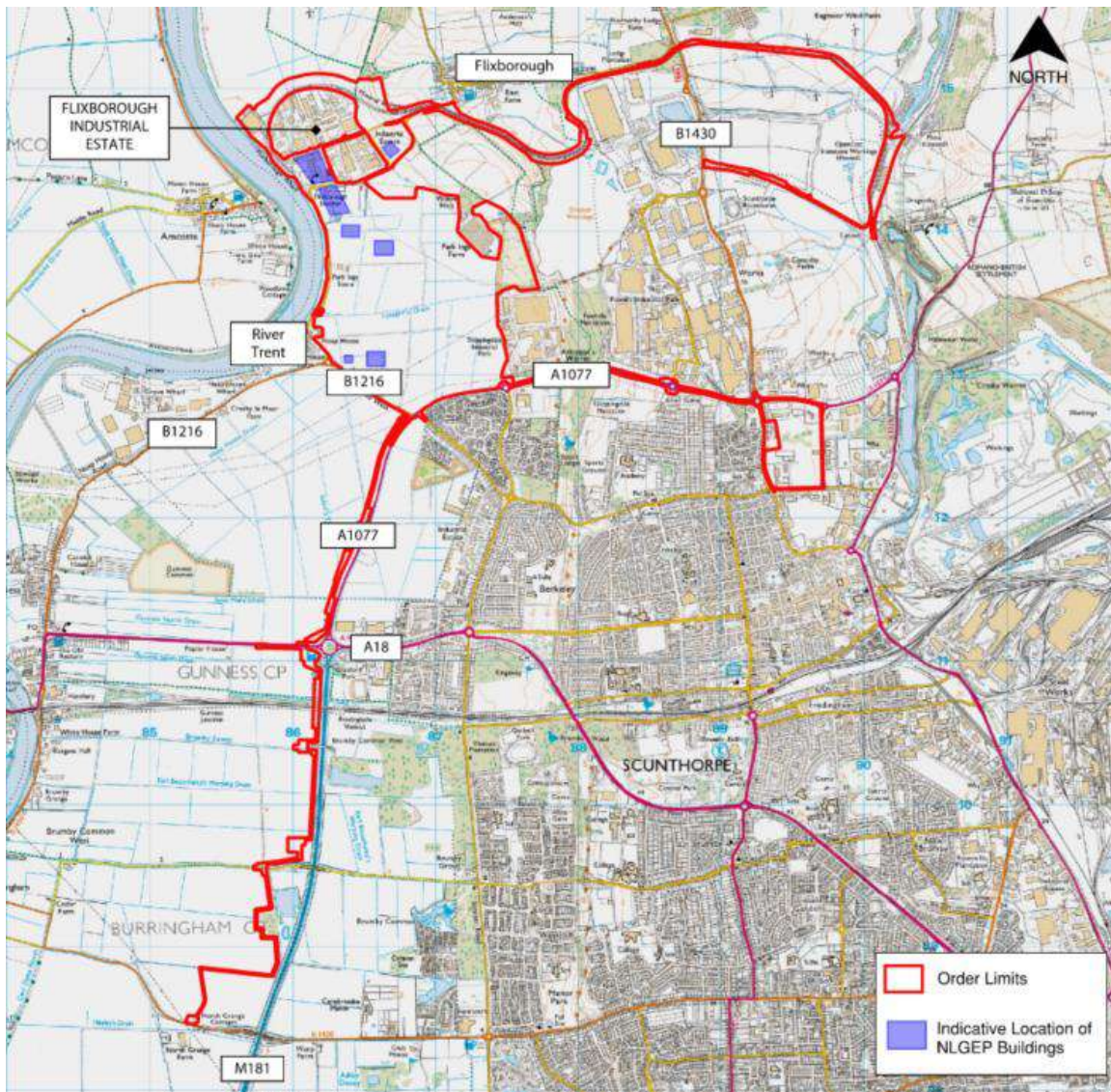

Figure 1.1 – Project Location Plan

1.1.9 North Lincolnshire Council (NLC) are the local planning and highway authority. National Highways (NH) are the highway authority responsible for the strategic highway network (M180/M181).

1.2 General Strategy

1.2.1 This Travel Plan has been prepared to set out the general strategy for managing multi-modal access to the Project whilst focusing on promoting access by sustainable modes. It is anticipated that implementation of this Travel Plan would be secured through the s106 agreement following a consent for the development.

- 1.2.2 It comprises general site-wide measures and initiatives that would be led by the Applicant to encourage employees and visitors to use more sustainable means of transport. In particular, to encourage walking and cycling wherever possible as these modes bring environmental and health benefits and can reduce the reliance on taxis and private car for local travel.
- 1.2.3 The aim of this Travel Plan is to provide employees and visitors with all the information they need to make sustainable travel choices easier from the outset before travel habits become entrenched.
- 1.2.4 This Travel Plan is a 'living document', which will be actively promoted with employees and visitors and will be reviewed and revised over time in consultation with NLC. It will be a continuous process for improvement, requiring monitoring, review and revision to ensure it remains relevant to those using the Project.
- 1.2.5 The Applicant will be responsible for taking this Travel Plan forward and for ensuring that any occupying tenants (Occupiers) at the Project sign up and comply with its contents.
- 1.2.6 Modal split estimations have been made for the Project and are set out in Section 6. These estimations will be compared with the actual modal split obtained as part of the Travel Surveys.
- 1.2.7 The Applicant will appoint a Travel Plan Co-ordinator 3 months prior to first occupation at the Project (taken to be when any part of the development is occupied) and will give details of the named representative to NLC when they are appointed. The appointed Travel Plan Co-ordinator will be responsible for managing and implementing this Travel Plan and this is discussed in more detail in Section 5.
- 1.2.8 Whilst preparing this Travel Plan, reference has been made to the following useful information sources:
- National Networks National Policy Statement (NN NPS) (2014)
 - National Planning Policy Framework (NPPF) (2021)
 - Department for Transport Strategic Road Network Circular 02/2013
 - North Lincolnshire Local Plan Saved Policies (2003)
 - North Lincolnshire Local Development Framework – Core Strategy (June 2011)
 - Emerging North Lincolnshire Local Plan (2022 / 2023)

- Planning Practice Guidance (PPG): Travel Plans (March 2014)
- Government Guidance on Travel Plans, Transport Assessments and Statements (March 2014)
- Department for Transport (DfT) Cycle to Work Scheme, Guidance for Employers (2019); and
- ACT TravelWise and Campaign for Better Transport - organisations promoting sustainable travel choices in the UK.

2 Planning Policy and Guidance

2.1.1 The following sets out the policy and guidance relevant to this Travel Plan.

2.1 National Networks National Policy Statement (DfT, 2014)

2.1.1 The National Networks National Policy Statement (National Networks NPS) sets out the need for, and Government's policies to deliver, development of Nationally Significant Infrastructure Projects (NSIPs) on the national road and rail networks in England.

2.1.2 The 'national road network' refers to the Strategic Road Network (SRN) which is managed by National Highways.

2.1.3 The Secretary of State will use this NPS as the primary basis for making decisions on development consent applications (DCO) for NSIPs in England.

2.1.4 The National Networks NPS provides specific transport policy for NSIPs where quite particular considerations apply. It also provides guidance on matters such as good scheme design, as well as the treatment of environmental impacts. The overall strategic aims of the National Networks NPS is consistent with the National Planning Policy Framework (NPPF 2021), which both seek to achieve sustainable development.

2.1.5 Whilst sustainable transport modes are encouraged, it is recognised in the National Networks NPS that it may not be *"realistic for public transport, walking or cycling to represent a viable alternative to the private car for all journeys, particularly in rural areas..."*.

2.2 National Planning Policy Framework (NPPF 2021)

2.2.1 The NPPF recognises that a Travel Plan is a key tool for promoting sustainable transport and that all developments generating significant amounts of movement should provide a Travel Plan.

2.2.2 Travel Plans should identify the specific required outcomes, targets and measures, and set out clear future monitoring and management arrangements all of which should be proportionate. They should also consider what additional measures may be required to offset unacceptable impacts if the targets should not be met.

2.2.3 Travel Plans need to set out clearly what data is to be collected, and when, and establish the baseline conditions in relation to any targets. The monitoring requirements will depend on the nature and scale of the development.

2.3 Planning Practice Guidance (PPG): Travel Plans (March 2014)

2.3.1 This guidance covers:

- when a travel plan is required
- how the need for and scope of a travel plan should be established
- what information should be included in travel plans; and
- How Travel Plans should be monitored.

2.3.2 This guidance provides advice on what information should be included in travel plans and on how it should be monitored. It states that *“Travel Plans should identify the specific required outcomes, targets and measures, and set out clear future monitoring and management arrangements all of which should be proportionate.”*

2.4 North Lincolnshire Local Plan (2003)

2.4.1 The North Lincolnshire Local Plan (adopted in May 2003) has been replaced by the Local Development Framework (discussed later in this section) but most policies from this Local Plan have been saved including the following sustainable transport-related policies summarised below:

T1 Location of Development: Development will be encouraged to locate in principal settlements where they *“are easily accessible by foot, cycle and public transport”* and where development involves significant movement of freight this should be located where *“good access is possible to rail, water and the North Lincolnshire Strategic Road Network.”*

T2 Access to Development: It is important that all development is accessible both for all modes of transport and by all users irrespective of any mobility impairment. *“It must be served adequately by public transport, cycling, walking and the existing highway network.”*

T5 Green Travel Plans: Employers can help promote sustainable mobility in North Lincolnshire by producing Green Travel Plans for the users of new developments.

T6 Pedestrian Routes and Footpaths: Major new developments will be required to include links to nearby existing or proposed pedestrian routes.

T7 Development of a Cycle Network: To promote cycling as a mode of transport.

T8 Cyclists and Development: New developments will be required to: i) include cycle links with existing or proposed routes where such opportunity exists; and ii)

ensure that the provision of cycle parking facilities are in accordance with the standards.

T9 Promoting Buses and Trains: The use of buses and trains will be encouraged as an alternative to the private car.

2.5 North Lincolnshire Local Development Framework – Core Strategy (2011)

2.5.1 North Lincolnshire’s main priority is to ensure that all developments are sustainable and complement and enhance the area’s high quality natural and built environment without any detrimental impact.

2.6 Emerging North Lincolnshire Local Plan (2022 / 2023)

2.6.1 This emerging Local Plan is intended to replace the saved policies from the adopted Local Plan and the Local Development Framework and is due to be published later this year / early 2023.

2.6.2 In terms of Travel Plans, it states that all Travel Plans would be expected to include the following:

- site assessment and audit
- impact assessment of the proposed uses
- objectives and overall strategy
- appropriate measures to encourage/deliver outcomes/targets
- targets
- arrangements for carrying out review and monitoring of the Travel Plan
- steps to be taken to promote/disseminate identified measures to the end users; and,
- timetable for implementation of measures.

2.6.3 It also states that the Travel Plan measures for each site will vary depending upon the circumstances of each development, the requirements and travel patterns of the site users and the constraints and opportunities offered by the site itself. However, measures which should be considered include:

- site layout designed to encourage and maximise opportunities to walk and cycle and allow for access by bus services and provision of bus stops

- provision of direct, convenient and attractive pedestrian and cycling routes to local facilities and which connect into the wider network
- information provided on the health benefits of walking and cycling (e.g. maps and online references)
- provision of secure, sheltered and adequate cycle parking facilities
- provision of changing/shower facilities, drying rooms and cycle locker facilities at workplaces
- introduction of financial incentives to encourage cycling (e.g. cycle mileage allowance for work use)
- provision of site-specific public transport information (e.g. maps, leaflets); and
- provision of discounted ticketing and season ticket loans.

2.6.4 For a Travel Plan to work successfully, a Travel Plan Coordinator should be appointed, who will be responsible for:

- implementing the Travel Plan measures
- liaising with users of the development and promoting sustainable travel
- liaising with stakeholders, including the Local Planning and Highway Authorities
- monitoring the effectiveness of the Travel Plan; and,
- reviewing the Travel Plan and preparing Action Plans.

3 Benefits and Objectives of this Travel Plan

3.1.1 The benefits of a Travel Plan are as follows:

- by encouraging walking and cycling it will provide opportunities to build healthy exercise into daily life
- the business/organisation can benefit from increased productivity generated by healthier, more motivated workforce, potential cost savings, reduced congestion, reduced demand for car parking and improved access by employees, visitors and deliveries
- the local community can enjoy lower pollution levels, reduced congestion, reduced journey times, improved public transport services and energy savings; and
- the environment generally can benefit from improved air quality, less noise, and reduced impact of other national and global environmental problems such as global warming.

3.1.2 The Travel Plan is not designed to deny the freedom of car use. It seeks instead to reduce the potential for congestion, to improve air quality and to resolve parking issues that may affect the Project and its immediate surroundings.

3.1.3 Through a range of initiatives, the Travel Plan will help the Applicant manage the travel needs of employees and visitors and to increase the range of travel options by which the Project can be accessed. Moreover, the promotion of walking and cycling initiatives will bring environmental and health benefits.

3.1.4 The primary objective of the Travel Plan is to reduce unnecessary vehicular trips, primarily single occupancy private car travel to and from the Project where suitable alternative modes of travel are available.

3.1.5 The objectives of the Travel Plan are to:

- ensure the Project is accessible to all and respects the needs of vulnerable groups such as those with mobility problems
- minimise the impact of congestion, noise and pollution
- where appropriate, reduce the need for unnecessary travel and ensure that those that do have to travel do so in a way that is sustainable
- specify measures to encourage employees and visitors to use travel modes other than the car

- minimise the number of Single Occupancy Vehicle (SOV) trips
- promote the use of public transport, motorcycles, car sharing, walking and cycling when getting to and from the Project
- reduce the environmental impact of travel demand by raising awareness amongst employees and visitors and by encouraging environmentally friendly behaviour; and
- minimise delivery vehicle trips by appropriate scheduling and/or through emission reduction initiatives.

4 Transport Accessibility

4.1.1 This chapter sets out the context of the Project in terms of accessibility.

4.1 Highway Access

4.1.1 The local highway network in the vicinity of the Project is shown on Figure 4.1.

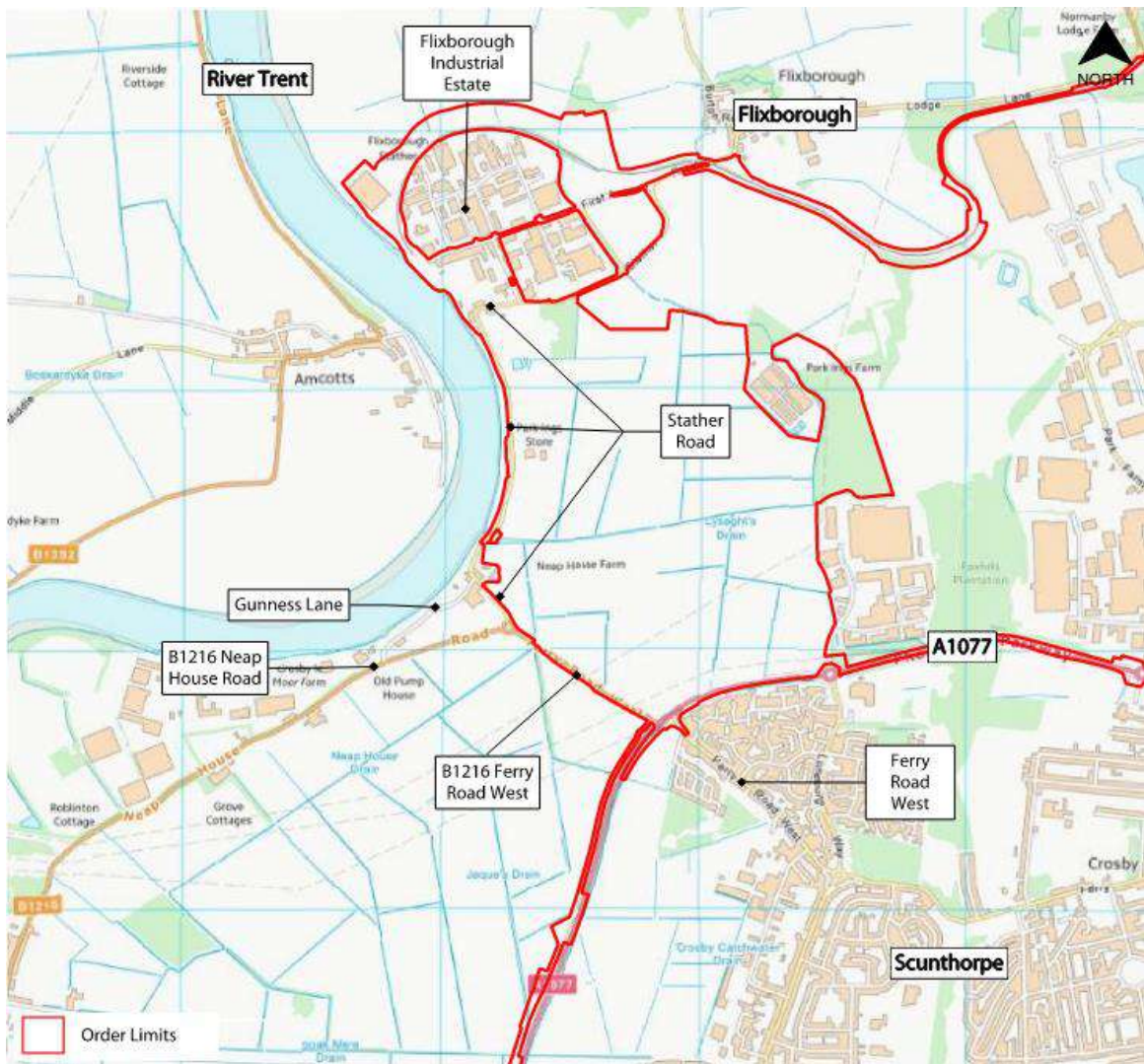

Figure 4.1 – Local Highway Network

4.1.2 In order to facilitate the proposed development, it is intended to stop up Stather Road from the existing surface water pumping station located north of Neap House to Flixborough Industrial Estate and provide a New Access Road between the B1216 Ferry Road West and Flixborough Industrial Estate (as indicated on Figure 4.1).

- 4.1.3 This proposed New Access Road is intended to serve the Project as well as the existing Flixborough Industrial Estate and Port area.
- 4.1.4 It is intended that existing traffic using Stather Road via Neap House, which is currently very narrow in places and generally unsuitable for two-way heavy good vehicle movements, will relocate to the New Access Road.
- 4.1.5 Vehicular access to the wider road network will primarily be to/from the south via the New Link Road, the B1216 and the A1077, which provides onward connections to the strategic highway network via the M181 and M180.
- 4.1.6 Vehicle access is also available via Stather Road to the east via Flixborough village, but this would be limited to cars and smaller vehicles only given the 7.5T weight restriction along this route.

4.2 Walking and Cycling

- 4.2.1 As part of the proposals, a new 3m wide shared pedestrian / cycle footway is proposed along the eastern side of the New Access Road, which will extend along the B1216 Ferry Road West to the A1077 where a new toucan crossing facility will be provided at the B1216 Ferry West Road / A1077 signal junction. This will significantly improve pedestrian /cycle connections between the Project, local facilities and the wider highway network.
- 4.2.2 This new 3m shared pedestrian / cycle footway will also extend along Stather Road and connect to the existing footway provision on Bellwin Drive at Flixborough Industrial Estate. A new section of shared footway is also proposed on First Avenue, which seeks to encourage pedestrian / cycle travel modes in this area.
- 4.2.3 The pedestrian / cycle infrastructure in the vicinity of the Project is shown on Figure 4.2.
- 4.2.4 National Cycle Network (NCN) Route 169 is located approximately 2.8km to the east of the Project. The route is known locally as the Scunthorpe Ridgeway and travels north to south through Scunthorpe, it passes through green open spaces and is approximately 8km in length. The route follows (off road) Normanby Road (2.8km to the east of the Project), it then crosses the A1077 Phoenix Parkway just east of the Luneburg Way / A1077 Roundabout via a toucan crossing. The route then continues southwards off road to the A18 Kingsway where a segregated cycleway is provided, which is separated from the road by a grass verge. It then continues south off-road to Burringham Road.

- 4.2.5 There are existing pedestrian footway connections to/from NCN 169 via a number of residential streets between Ferry West Road and Luneburg Way, which also provide quiet routes for cyclists.
- 4.2.6 There are also a number of Public Rights of Way (PRoW) routes which exist in the vicinity of the Application Land, as indicated on Figure 4.2 with potential to extend these east-west across the Application Land to enhance connections to the Riverside. An informal crossing point with suitable drop kerbs and tactile paving will be provided where it crosses the New Access Road.

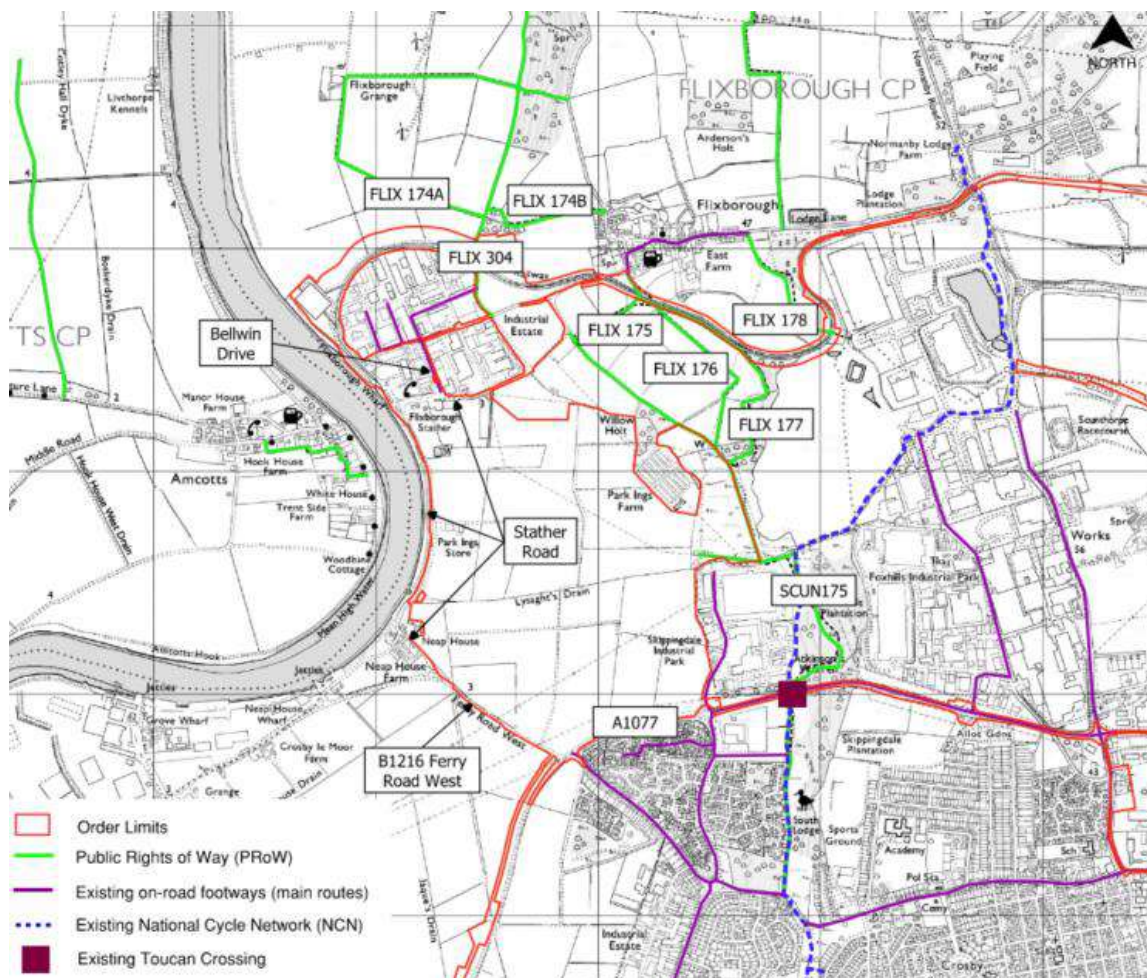

Figure 4.2 - Pedestrian and Cycle Infrastructure in the vicinity of the Project

- 4.2.7 These existing pedestrian / cycle facilities, together with the proposed shared pedestrian/cycle footway along the B1216 and the New Access Road will provide good pedestrian/cycle accessibility to/from the Project.
- 4.2.8 Figure 4.3 shows the areas that can be reached within a 10, 20 and 30-minute walk based on typical walking speeds.

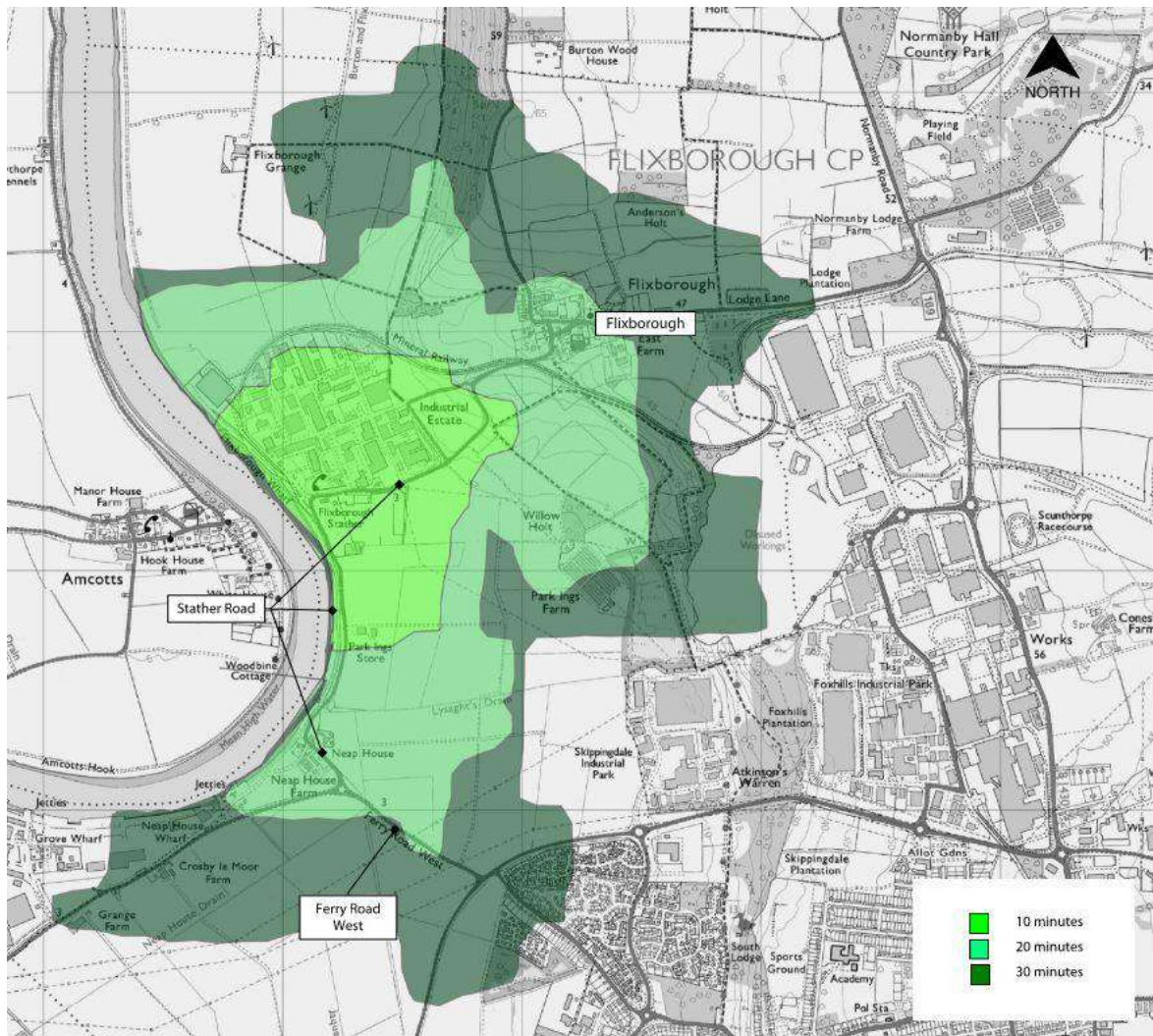

Figure 4.3 – Walking Isochrones

4.2.9 Whilst the suggested maximum walking distance for typical journeys by foot from commercial developments is 2km / 20 minutes (as set out in the ‘Providing for Journeys on Foot’ Guidance by the Chartered Institute of Highways and Transportation), there may be some people who may consider walking (or running / jogging) further than this.

4.2.10 The walking isochrones show that Flixborough village is within a 20-minute walk and Ferry Road West to the south of the A1077 is within a 30-minute walk.

4.2.11 Whilst Scunthorpe and Althorpe railway stations are outside reasonable walking distances, they are accessible within a 20-30-minute cycle as indicated on Figure 4.4.

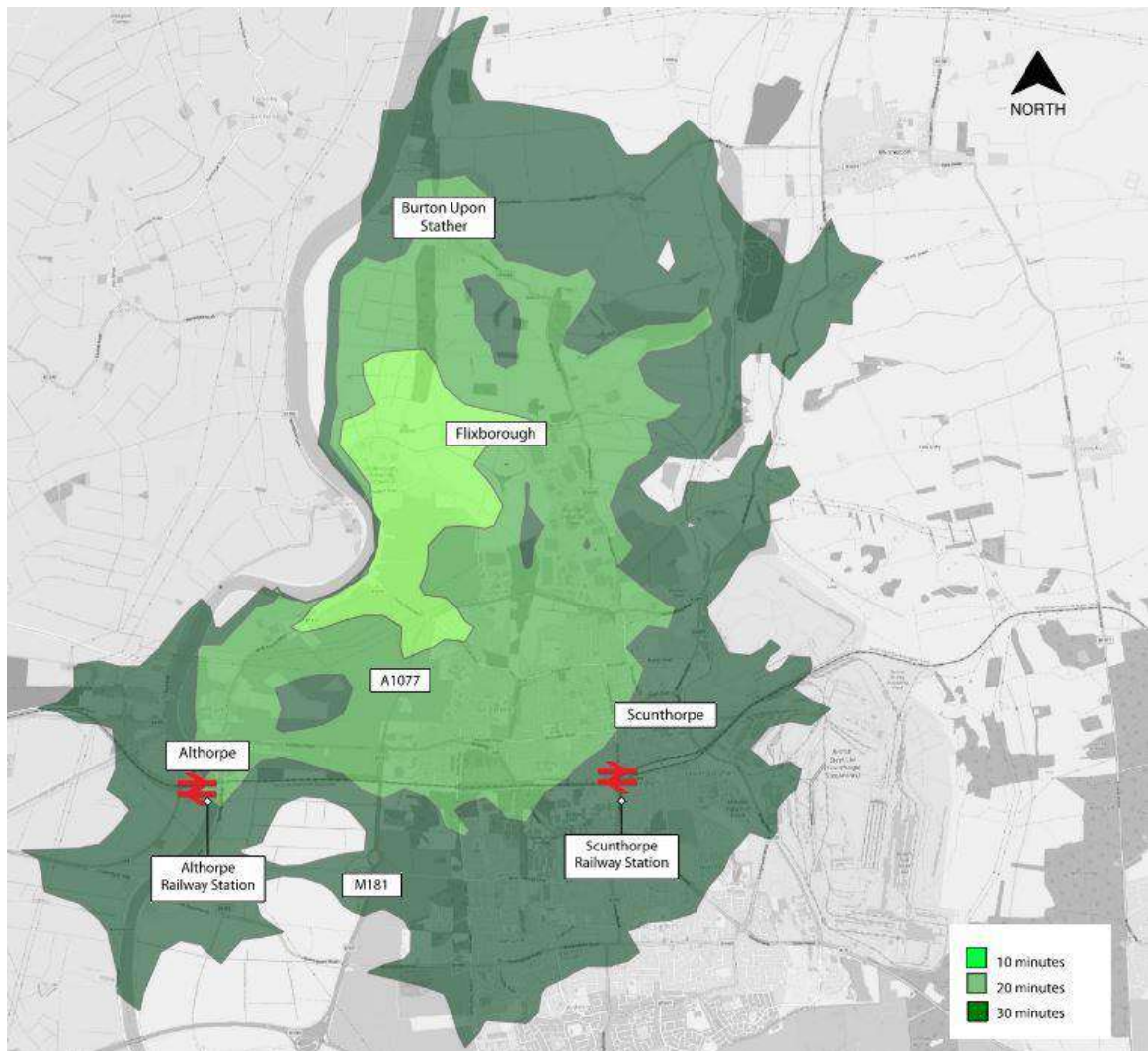

Figure 4.4 -Cycling Isochrones

- 4.2.12 Cycling is an inexpensive, efficient and healthy way to travel. It is recognised that it can provide a realistic and healthy alternative to the use of the private car for making journeys up to 8km (30-minute cycle ride) or as part of a longer journey by public transport.
- 4.2.13 Scunthorpe town centre is located approximately 20-25 minutes cycle ride from the Project, where a wide range of amenities can be found. Scunthorpe railway station is also approximately 25 minutes cycle ride from the Project and Althorpe railway station is a 20-minute cycle ride approximately.

4.3 Public Transport

- 4.3.1 The nearest bus service serving the Project (Bus Route 60) runs along Stather Road. Bus Route 60 runs north-south from Whitton via Burton upon Stather and Flixborough to Scunthorpe via the bus and railway stations to John Leggott sixth form college situated to the south of Scunthorpe town centre.
- 4.3.2 The 'Flixborough Stather Wharf' bus stops are situated on Stather Road adjacent to the Flixborough Port access. There is no physical bus infrastructure provided at this location (such as bus stops etc) as this bus route forms part of NLC's rural bus network, which operates an on-demand bus service via 'JustGo North Lincs'.
- 4.3.3 The 'JustGo North Lincs' on demand bus service allows passengers to book and pay online for their bus journey through the JustGo mobile app, as well as choosing where they get picked up from. The service can be booked up to 30 days in advance up until the day of departure.
- 4.3.4 As part of the proposal to stop up Stather Road via Neap House, Bus Route 60 will be diverted via the proposed New Access Road.
- 4.3.5 There are also additional bus services (Routes 7 and 8) available via Ferry Road West with bus stops located approximately 90 metres south of the A1077. These bus stops are within a 10-minute cycle ride / 30-minute walk of the Project.
- 4.3.6 A summary of the bus routes in the vicinity of the Project and their frequencies is shown below in Table 4.1. Bus services are generally hourly through the day Monday to Saturday, with limited services during the morning highway peak periods and no services on a Sunday.

Table 4.1 – Bus Routes and Service Frequencies

Bus Route	Monday to Friday	Saturday
60 Scunthorpe bus station via Flixborough to Whitton	Northbound	
	First bus from Scunthorpe bus station: 1000 Arriving at Flixborough Stather Wharf at 1015 Then at 1115 1220 1450 1645 1645 and 1800 towards Whitton	Same timetable as Weekday
	Southbound	
	First bus from Whitton: 0730 Arriving at Flixborough Stather Wharf at 0800	Same timetable as Weekday

	Then at 0939 1045 1145 1318 and 1543 towards Scunthorpe	
7 Scunthorpe bus station to Skippingdale Retail Park	Northbound Only	
	First bus from Scunthorpe bus station: 0905 Arriving at Ferry Road West at 0922 Then hourly from Scunthorpe bus station with last bus at 1805	First Bus from Scunthorpe bus station: 09:10 Arriving at Ferry Road West at 0924 Then hourly from Scunthorpe bus station with last bus at 1810
8 Scunthorpe bus station to Skippingdale Retail Park	Northbound	
	First bus from Scunthorpe bus station: 0935 Arriving at Ferry Road West at 0951 Then hourly with last bus from Scunthorpe at 1735	First Bus from Scunthorpe bus station: 09:50 Arriving at Ferry Road West (Charnwood Caravan Park) at 10:04 Then hourly with last bus towards Scunthorpe at 1850
	Southbound	
	First bus from Skippingdale Retail Park: 0927 Arriving at Ferry Road West (Charnwood Caravan Park) at 0929 Then hourly with last bus towards Scunthorpe at 1829	First Bus from Skippingdale Retail Park: 0929 Arriving at Ferry Road West (Charnwood Caravan Park) at 0931 Then hourly with last bus towards Scunthorpe at 1831

4.3.7 Scunthorpe railway station is located a short walk from Scunthorpe town centre, which is approximately 4.5 kilometres south-east of the Project and can be reached by bus (approximately 15 to 20-minute bus journey) or by cycle (approximately 250-minute cycle ride).

4.3.8 Scunthorpe and Althorpe stations are both served by Northern Trains (NT) and the TransPennine Express (TPE).

4.3.9 Scunthorpe station has two platforms, Platform 1 serves mainly TPE eastbound trains towards Grimsby / Cleethorpes with some NT westbound services towards Doncaster. All westbound TPE services, and most NT services use Platform 2. There is an hourly TPE service eastward to Cleethorpes and westbound there in an hourly TPE service to Manchester Piccadilly and Manchester Airport, with an hourly local NT service calling at all intermediate stations towards Doncaster. Trains operate throughout the week (Monday to Sunday).

4.3.10 Scunthorpe station has step free access from the station entrance to all platforms.

4.3.11 Althorpe railway station is mainly served by NT, which operates east-west from Scunthorpe via Althorpe, Crowle to Doncaster and onward connections to Sheffield. There are also occasional TPE services via this station. Train services operate Monday to Saturday with an hourly service. Althorpe station has two platforms, Platform 1 (Eastbound) and Platform 2 (westbound) and the station does not currently provide step free access with Platform 1 only accessible by a footbridge with steps.

4.3.12 Table 4.2 provides an overview of the train frequencies at these railway stations.

Table 4.2 – Train Frequencies at Scunthorpe and Althorpe Stations

Destination	Weekday AM	Weekday PM	Saturday	Sunday
Scunthorpe Station				
Doncaster	Every 30 Minutes	Every 30 Minutes	Every 30 Minutes	Hourly
	First Train: 05:47	Last Train: 22:48	First Train: 05:47 Last Train: 22:48	First Train: 10:07 Last Train: 21:58
Cleethorpes	Hourly	Hourly	Hourly	Hourly
	First Train: 06:19 Last Train: 23:12	First Train: 06:19 Last Train: 23:12	First Train: 06:19 Last Train: 23:12	First Train: 10:04 Last Train: 23:05
Manchester Piccadilly	Hourly	Every 30 Minutes	Every 30 Minutes	Hourly *
	First Train: 05:47	Last Train: 22:48	First Train: 05:47 Last Train: 22:48	First Train: 10:07 Last Train: 21:08
Althorpe Station				
Doncaster	2 Hours	2 Hours	2 Hours	No Services
	First Train 05:52	Last Train 22:53	First Train: 05:52 Last Train: 22:53	

4.4 Access Provision for the Mobility Impaired

4.4.1 Bus services operating in the vicinity of the Project are low floor buses, fitted with ramps for wheelchair access.

4.4.2 In terms of rail travel, Scunthorpe railway station is step-free, providing accessible routes for the mobility impaired between the entrances and the platform.

- 4.4.3 Suitable drop kerbs and tactile paving are provided at signal-controlled pedestrian/cycle crossing facilities in the area to assist the mobility impaired and partially sighted.
- 4.4.4 Accessible / disabled car parking spaces are proposed at the Project for disabled motorists (refer to Section 7).

5 Travel Plan Management

5.1 Travel Plan Co-ordinator

5.1.1 Allocated time will be needed to set up and run the Travel Plan. This is best achieved by appointing a Travel Plan Co-ordinator who will be responsible for the management and maintenance of the Travel Plan.

5.1.2 The Travel Plan Co-ordinator will have sufficient authority, resources and capability to implement, manage and ensure compliance with the Plan.

5.1.3 The Applicant will appoint a Travel Plan Co-ordinator 3 months prior to first occupation at the Project (taken to be when any part of the development is occupied) and will give details of the named representative to NLC when they are appointed.

5.1.4 The role will be fulfilled by a nominated representative, or an appropriate consultant appointed by the Applicant.

5.1.5 The Travel Plan Co-ordinator will be responsible for:

- overseeing the development and implementation of the Travel Plan and for promoting the objectives and benefits of the Travel Plan
- designing and implementing effective marketing and awareness raising campaigns to promote the Travel Plan
- co-ordinating the necessary data collection required to develop the Travel Plan, which includes arranging for the Travel Survey to be carried out to establish travel patterns at the Project (discussed in Section 6 and devising possible incentives for employees to complete and return their questionnaires
- collation of all the Travel Survey information and entering it onto a database to help identify travel requirements and set targets for reducing single occupancy car trips and increasing sustainable travel modes
- acting as a point of contact to all employees and visitors requiring information in relation to sustainable travel as well as for exchanging ideas and best practice with other organisations
- liaising with NLC and local public transport operators; and
- co-ordinating the monitoring programme of the Travel Plan and producing Monitoring Reports (as discussed in Section 8).

5.2 Securing the Travel Plan and Funding

- 5.2.1 The preliminary modal split set out in Section 6 will be reserved for agreement with NLC after the initial baseline travel survey has been undertaken (the travel survey timescales are discussed in Section 6.4).
- 5.2.2 The Applicant will ensure that the Travel Plan Co-ordinator is provided with sufficient funding and resources to implement and monitor this Travel Plan.
- 5.2.3 A commitment to the Travel Plan strategy will be secured through a suitably worded planning Condition or a Section 106 Agreement.

6 Travel Survey and Mode Split Targets

6.1 Site Users

6.1.1 There are several different operational elements at the Project and employees are expected to work in shifts.

6.1.2 The key number of employees anticipated at the Project is shown below in Table 6.1.

Table 6.1: The Project – Total Number of Employees

The Project	Total Number of Employees
ERF	62
Concrete Block Manufacturing Facility	40
Railhead	10
Plastic Recycling Facility	130
Electric Vehicle and Hydrogen refuelling station	5
Visitor Centre	10
TOTAL	257

6.1.3 The majority of employees are expected to work in shifts with five shifts for operational employees and three shifts for maintenance employees. These shifts typically include a day shift (0700 to 1500 or 0800 to 1700), a late shift (1500 to 2300 or 1400 to 2200) and a night shift (2300 to 0700).

6.1.4 The graph below indicates the number of employees on the Project on a typical working day and shows that the maximum number of employees on the Project at any one time is expected to be 174 between 1400 and 1500 hours.



Figure 6.1 -The Project – Number of Employees through the day

6.2 Preliminary Mode Split

6.2.1 The employee modal split has been extracted from the TA and is shown below in Table 6.2.

Table 6.2: Mode Split of Travel

Mode of Travel	Percentage Mode Split
Car Driver	76%
Car Passenger	10%
Walk	3%
Cycle	4%
Bus	4%
Motorcycle	1%
Train	2%
TOTAL	100%

6.2.2 This modal split will be reviewed against the actual employee modal split obtained as part of the baseline Travel Survey has been undertaken.

6.2.3 Table 6.3 shows the number of employees expected by each mode.

Table 6.3: The Project – Employee Trips by Mode

Mode of Travel	Number of Employees
Car Driver	195
Car Passenger	26
Walk	8
Cycle	10
Bus	10
Motorcycle	3
Train	5
TOTAL	257

6.2.4 In terms of employee car trips, this represents a peak of 45 arrivals and 46 departures in the morning (07:00 – 08:00), and a peak of 0 arrivals and 53 departures in the evening (17:00 – 18:00) with 46 arrivals and 4 departures in the late evening peak (22:00 – 23:00).

6.3 Preliminary Targets

- 6.3.1 Modal travel targets provide the Travel Plan Coordinator and NLC means to measure the performance of the Travel Plan and to adjust the range of initiatives accordingly.
- 6.3.2 Table 6.4 shows preliminary targets for Years 1, 3 and 5 of the Travel Plan, which will be subject to review once the baseline Travel Survey has been undertaken.
- 6.3.3 These targets are considered to be SMART (Specific; Measurable; Achievable; Realistic and Time-bound) and are in line with the primary objective of the Travel Plan, which is to reduce car travel where alternative sustainable modes of travel are available.
- 6.3.4 Table 6.4 sets out preliminary targets to reduce the number of employees driving their car to work by 15% over the 5-year timeframe and increasing the number of employees car sharing (by 5%), using public transport (by 5%) and cycling (by 5%).
- 6.3.5 Given the anticipated employee shift patterns at the Project i.e. working nights, public transport and cycling travel modes may not provide a suitable alternative to the car for all employees.

6.3.6 Similarly, some employees may not be locally based, in which case walking and cycling may not provide a viable option. The Travel Plan Co-ordinator will review these preliminary targets in relation to the baseline Travel Survey results.

Table 6.4 Preliminary Targets for Employees at the Project

Target	Target Modal Split		
	Year 0 (Baseline)	Year 3	Year 5
Reduce car driver mode by 15%	76%	71%%	66%
Increase car share mode by 5%	10%	13%	15%
Increase Public Transport use by 5%	6%	9%	11%
Increase Cycling by 5%	4%	7%	9%

6.4 Travel Survey

- 6.4.1 A Travel Survey is an essential part of a Travel Plan. It is carried out to establish travel patterns at the Project and to ascertain what would encourage employees to travel in a sustainable way.
- 6.4.2 The Travel Survey, which is generally undertaken by means of a self-completion questionnaire, helps to identify the proportion of employees travelling by each mode of transport i.e. the modal split.
- 6.4.3 Within 6 months of occupation, or at 75% occupancy, whichever comes sooner, the Travel Plan Co-ordinator will arrange for the baseline Travel Survey to be undertaken.
- 6.4.4 Following the baseline Travel Survey, further Travel Surveys would be undertaken at Years Three and Five.
- 6.4.5 A minimum Travel Survey response rate of 30% is recommended in order to obtain a representative survey sample. An incentive will be considered to encourage employees to complete and return their questionnaires to help maximise the response rate. Surveys should ideally be undertaken in a 'neutral' month, avoiding school holidays and at a similar time each year for consistency.
- 6.4.6 The survey results are used to formulate and monitor the implementation of the Travel Plan and to set and review baseline targets for promoting sustainable and healthy travel. This information, together with the proposed baseline targets, would be detailed in a Monitoring Report (discussed in Section 8) which will be sent to NLC for its consideration within 3 months of the Travel Survey being undertaken.

7 Travel Plan Initiatives and Measures

- 7.1.1 Employee travel survey results would be used to identify site specific issues, which in turn would inform suitable measures and initiatives to be put in place in order to encourage the use of sustainable travel modes by employees and visitors when accessing the Project.
- 7.1.2 For the purposes of this Travel Plan, and prior to the development and analysis of the initial / baseline employee Travel Survey, a range of physical, managerial and awareness measures are suggested below for implementation at the Project.
- 7.1.3 The Travel Plan Co-ordinator will be responsible for the marketing and publicity of all travel information and Travel Plan initiatives at the Project in discussion with the Applicant and other key stakeholders.

7.2 Travel Information Pack

- 7.2.1 A Travel Information Pack will be prepared (and funded) by the Applicant, which will be distributed to all employees prior to occupation at the Project. The Pack will highlight the objectives of the Travel Plan and include details relating to sustainable travel.
- 7.2.2 A key role of the Travel Information Pack is to raise awareness of the sustainable travel initiatives being implemented through the Travel Plan including:
- **Access initiatives:** A map showing local cycling, walking and public transport routes to/ from the Project, together with the locations of any key local facilities (such as shops, cashpoint etc) within walking distance. Additional sources of further information such as TraveLine's Journey Planner will also be provided.
 - **Promotion of key services and facilities:** Details of the key services and facilities such as the location of cycle parking/maintenance facilities will be included within the Pack.
 - **Promotion of car share clubs:** Details of local car sharing websites such as [REDACTED] will be included within the Pack.
- 7.2.3 The Travel Information Pack will be reviewed annually by the Travel Plan Co-ordinator and updated where appropriate.

7.3 Measures to Promote Walking and Cycling

- 7.3.1 The pedestrian environment within the Project will be of high quality, with the provision of well-maintained routes and the use of quality materials.
- 7.3.2 Encouraging walking and cycling gives opportunities to build healthy exercise into daily life. It also reduces the reliance on taxis and private hire vehicles for local travel.
- 7.3.3 Kitchen facilities are proposed at each of the buildings at the Project for employees (excluding the refuelling station), which will include a breakout area. In addition, a shop will be provided at the proposed refuelling station. Consideration will also be given to providing a cashpoint at this shop. These facilities are within easy walking distance and will seek to minimise any car trips at lunchtimes / break times.
- 7.3.4 The Applicant will also provide long stay (employee) and short-stay (visitor) cycle parking at the Project together with changing facilities and lockers, which will seek to encourage active travel to/from the Project.
- 7.3.5 The long stay (employee) cycle parking will be provided in an enclosure within the building (s) at ground floor level. The type of cycle parking being provided will be determined at the next stage as the design progresses but is likely to include good proportion of Sheffield cycle stands, which are suitable for cyclists of all ability.
- 7.3.6 The short-stay (visitor) cycle parking will be located adjacent to the building (s) entrances, which will be well-overlooked, covered and secure. These will be in the form of Sheffield cycle stands.
- 7.3.7 The total number of cycle parking spaces to be provided at the Project is shown in Table 7.1.

Table 7.1 Proposed Cycle Parking at the Project

The Project	Number of Cycle Parking Spaces	
	Employee (Long-Stay)	Visitor (Short Stay)
ERF / Railhead	20	4
Plastic Recycling Facility	14	4
Concrete Block Manufacturing Facility	14	4
Visitor Centre	4	8
Electric vehicle and hydrogen refuelling station	2	4
TOTAL=	54	24

- 7.3.8 It is noted that the proposed level of employee cycle parking allows for around 20% of employees cycling to/from work should it be required, which is beyond the interim 5-year target of 9%.
- 7.3.9 The Travel Plan Co-ordinator will monitor cycle parking usage at the Project, in discussion with the Applicant, to ensure that there are adequate cycle parking facilities provided, including for any future increases anticipated over the lifetime of the Travel Plan.
- 7.3.10 The Travel Information Pack will contain details relating to key pedestrian and cycle routes in the area and will include details to promote the following:
- 'Bike Week' [REDACTED]
 - local cycle training courses
 - National Walking Month, which includes 'walk to work' and 'walk to school' week [REDACTED]
 - the location and contact information of the nearest bike retail stores; and
 - Cycle to work scheme. Cycling to work is encouraged by the Government's green transport plan, which introduced a tax exemption allowing employers to loan cycles and cyclists' safety equipment to employees as a tax-free benefit. Details of this are set out in the Department for Transport's (DfT) 'Cycle to Work Scheme implementation Guidance', which can be found on the DfT's website www.gov.uk/government/publications/cycle-to-workscheme-implementation-guidance.
- 7.3.11 The Travel Plan Co-ordinator will investigate the creation of a Bicycle User Group (BUG) for employees at the Project, to provide the opportunity for cyclists to meet informally and discuss cycling related issues.
- 7.3.12 As part of the Travel Information Pack, employees will be asked to express their interest in provision of a 'Bike Doctor' event and/or whether they may be interested in championing a Bicycle User Group (BUG), which will be set up by the Travel Plan Co-ordinator if required.
- 7.3.13 The Applicant/Travel Plan Co-ordinator will also consider provision of free cycle health checks at 'bike doctor' sessions (by appointment only), which will be detailed in the Travel Information Pack.

- 7.3.14 Essential maintenance facilities such as bicycle pumps will be available for use by employees at the Project, which would be stored in boxes kept in the main reception area at the various Energy Park buildings. The Travel Plan Co-ordinator will regularly check that these facilities are in good working order and remain available to employees.
- 7.3.15 The Applicant will periodically offer incentives to employees to promote cycling such as loans, discounts and vouchers towards the cost of purchasing a bicycle and/or bicycle equipment.

7.4 Measures to Promote Public Transport

- 7.4.1 The Travel Information Pack will include details on where to obtain current timetable information for local bus and rail services. This will also be displayed on notice boards (and/or through web-based informational material) for employees, together with any new travel initiatives or events organised as part of the Travel Plan.
- 7.4.2 Community notice boards will also be placed in prominent locations within the building (s) and will display travel and community information for employees and visitors. Maps of the immediate local area will also be displayed identifying the location of car sharing spaces and public transport services and this information will be updated annually by the Travel Plan Co-ordinator where appropriate.
- 7.4.3 The notice boards will also be used to inform employees of any new travel initiatives or events organised as part of the Travel Plan.
- 7.4.4 The Applicant will consider providing interest free season ticket loans for employees using public transport and will investigate employee travel discounts with local public transport operators.
- 7.4.5 The Travel Plan Co-ordinator will offer personalised travel planning guidance to employees and this will be promoted through the Travel Information Pack. This will include help in providing localised, simplified travel information on their best option for use of other sustainable means of transport as an alternative to private vehicles. This will be combined with information regarding any incentives available such as public transport/cycle vouchers, shuttle bus services etc.

7.4.6 Subject to the outcome of the baseline Travel Survey, and to further encourage travel by public transport, the Travel Plan Co-ordinator, together with the Applicant, will consider the options for extending the existing bus timetables in the area (to suit employee shift patterns at the Project) and/or providing a private shuttle bus service. These provisions would be considered based on employee demand and in discussion with NLC / local public transport operators.

7.5 Measures to Promote Car Sharing

7.5.1 Initiatives like car sharing can provide a great alternative to car ownership and save on the associated running costs of a car.

7.5.2 Car sharing schemes aim to encourage individuals to share private vehicles for particular journeys. It includes informal arrangements for sharing trips between individuals at neighbourhood, workplace and even household level, as well as formal schemes with elaborate arrangements for trip matching, often focused on commuting journeys.

7.5.3 Car sharing will be promoted as part of the Travel Information Pack to minimise single occupancy vehicle trips. Information on car sharing can be found at 

7.5.4 Where appropriate, the Travel Plan Co-ordinator will encourage employees to join a car-sharing scheme.

7.5.5 Car sharers will be offered dedicated or preferential car parking spaces at the Project.

7.5.6 A nominated taxi company will be used to provide a lift home to car sharers whose expected lift does not materialise or in the event of an emergency.

7.6 Electric Vehicle Parking Spaces/Charging Points

7.6.1 In order to encourage the use of electric vehicles at the Project, a minimum of 15 car parking spaces will be provided with electric vehicle charging infrastructure, which will include at least two of the disabled spaces.

7.6.2 All remaining car parking spaces at the Project will be provided with passive electric vehicle charging infrastructure where the required network of cables is provided from the outset and should it be required for use at a later date, the electricity supply would be activated, and the necessary charging equipment provided.

7.6.3 The electric vehicle charging requirements would be reviewed by the Travel Plan Co-ordinator as part of the Travel Survey to ensure there is adequate provision to meet demand.

8 Monitoring and Review

- 8.1.1 On-going monitoring of the Travel Plan is necessary to ensure its continuous effectiveness. This will be the responsibility of the Travel Plan Co-ordinator.
- 8.1.2 The Travel Survey discussed in Section 6 will provide a baseline situation for setting appropriate modal shift targets to be met over the 5-year timeframe of the Travel Plan. The Travel Plan Co-ordinator will arrange for the baseline Travel Survey to be undertaken within 6 months of occupation (or at 75% occupation, whichever comes sooner). Following this, the Travel Survey will then be undertaken at Years One, Three and Five.
- 8.1.3 This information will be included in a Monitoring Report (also known as a Progress Report), which will be prepared annually and submitted to the NLC for consideration.
- 8.1.4 This Monitoring Report should include the following:
- organisation's name and address
 - detailed information and evidence on the measures used and implemented to promote the Travel Plan and its objectives
 - travel survey results with comparative data and analysis
 - proposed Specific, Measurable, Achievable and Time bound (SMART) targets
 - whether the travel habits of employees are meeting the objectives and targets
 - details on cycle parking usage;
 - updated Action Plan; and
 - details of any changes at the Project.
- 8.1.5 The Travel Plan Co-ordinator will collate the results of the Travel Survey and this information, together with the proposed baseline targets, will be detailed in the Monitoring Report, which will be sent to NLC for its consideration within 3 months of the Travel Survey being undertaken.
- 8.1.6 Where targets are not met, the Travel Plan Co-ordinator, in consultation with NLC, will discuss and agree a plan of action, which will indicate how any deficiencies in the operation of the Travel Plan will be met.

- 8.1.7 The Travel Plan Co-ordinator shall review and monitor the Travel Plan at Years One, Three and Five setting out whether the travel habits of employees are meeting the objectives and targets. This information will be included in the annual Monitoring Report.
- 8.1.8 After the initial five-year cycle, monitoring will continue on a voluntary basis every two years thereafter. At the completion of each five-year cycle, a review of the targets should take place, before new objectives, targets and appropriate measures are set, and a new five-year cycle begins.
- 8.1.9 In the event that targets have not been achieved in Year Five, the Travel Plan Co-ordinator will undertake further monitoring of the Travel Plan for Years Six, Eight and Ten. The Applicant will cover the cost of this additional monitoring in the event that it is required, together with any agreed additional measures that may be needed to get targets back on track

9 Action Plan

9.1.1 The Action Plan sets out actions, timescales and responsibilities. It will be updated by the Travel Plan Coordinator as part of the annual Monitoring Report.

Table 9.1 Interim Action Plan

Action	Timescale	Responsibility
OBJECTIVE: To put in place a mechanism for implementing and monitoring the Travel Plan		
Highlight the requirements of the Travel Plan to all employees	Prior to occupation	Applicant/TPC
Appoint TPC and notify NLC of their appointment	3 months prior to occupation	Applicant
OBJECTIVE: Surveys and monitoring		
Undertake baseline Travel Survey	Within 6 months of occupation (or at 75% occupation, whichever is sooner)	TPC
Devise a suitable incentive for employees to complete the Travel Survey	Prior to Travel Survey	TPC /Applicant
Undertake future Travel Surveys at Years One, Three and Five	At Years One, Three and Five of Travel Plan	TPC
Submit Monitoring Report (Progress Report) to NLC summarising survey results and proposed measures/targets	Within 3 months of the Travel Survey	TPC
Subsequent Monitoring (including annual reports to NLC)	Annually	TPC
TARGET: To increase sustainable travel modes at the Project		
Prepare the Travel Information Pack and review/update annually	Prior to occupation / Annual Review	Applicant
Provide all employees with a copy of the Travel Information Pack	Prior to occupation	TPC
Provide noticeboard (s) within the building and/ or update company Intranet to provide up-to-date public transport and other sustainable travel information to employees	Within first year of occupation (details to be updated annually)	Applicant/TPC
Consider providing interest free season ticket loans for employees using public transport	Within first year of occupation (following Travel Survey)	Applicant

Action	Timescale	Responsibility
Investigate provision of a private shuttle bus for employees and/or extending existing public bus timetables in discussion with NLC	Within first year of occupation (following Travel Survey)	Applicant/TPC
Offer a personalised travel planning service to all employees at the Project	Within first year of occupation	TPC
TARGET: To increase the percentage mode share of employees walking and cycling to work		
Provision of a new shared pedestrian/cycle footway connection to/from the Project via B1216 and A1077	Prior to occupation	Applicant
Provide cycle parking, showers/changing facilities and cycle maintenance facilities at the Project	Prior to occupation	Applicant
Promote Bike Week through notice boards	Annually	TPC
Create a Bicycle User Group for employees at the Project	Within first year of occupation (following Travel Survey)	TPC
Endeavour to negotiate discounts with local cycle/public transport operators	Within first year of occupation	Applicant/TPC
Make employees aware of the Cycle to work scheme (tax-free bicycle loan scheme for employees) and encourage them to make use of the scheme	Within first year of occupation	TPC
Promote National Walking Week through notice boards	Annually	TPC
Prepare a map showing local amenities within easy walking/cycling distance and display on notice board/Intranet	Within first year of occupation	TPC
Encourage walking/cycling for local journeys	Within first year of occupation (ongoing)	TPC
TARGET: To reduce single car occupancy use		
Promote car sharing and encourage employees to join a local car share scheme	Within first year of occupation (following Travel Survey)	TPC

Note:

TPC = Travel Plan Co-ordinator

Applicant = North Lincolnshire Green Energy Park Ltd

Natalie Maynard
Buro Happold Limited
17 Newman Street
London
W1T 1PD
UK



APPENDIX D OUTLINE CONSTRUCTION LOGISTICS PLAN

Date: May 2022

North Lincolnshire Green Energy Park

Draft Outline Construction Logistics Plan

0046658-TP-REP-004

0046658

27 May 2022

Revision P2

Revision	Description	Issued by	Date	Checked
P0	Issued for DCO submission	NJH	14/03/22	NM
P1	Issued for DCO submission	NJH	25/05/22	NM
P2	Re-Issued for DCO submission	JW	27/05/22	NM

This report has been prepared for the sole benefit, use and information of North Lincolnshire Green Energy Park Limited for the purposes set out in the report or instructions commissioning it. The liability of Buro Happold Limited in respect of the information contained in the report will not extend to any third party.

author **Neil Hamill**

date **27/05/22**

approved **Natalie Maynard**

signature

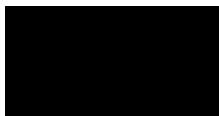

date **27/05/22**

Contents

1	Introduction	7
1.1	Preamble	7
1.2	DCO Application Description	7
1.3	CLP Purpose and Objectives	9
1.4	CLP Structure	10
2	Context, Considerations and Challenges	12
2.1	Policy Context	12
2.2	Initiatives and Guidance	14
2.3	Local Access Context	16
2.4	Freight Transport	20
2.5	Considerations and Challenges	20
3	Construction Programme and Methodology	22
3.1	Programme and Phasing	22
3.2	Methodology	25
4	Vehicle Routes and Access	35
4.1	Routing of HGV Construction Traffic	35
4.2	Routing of Construction Workforce Travel	38
4.3	On-Site Traffic Management	38
4.4	Public Rights of Way Considerations	40
4.5	Temporary Traffic Management and Traffic Regulation Orders	41
4.6	Network Rail Asset Protection	41
5	Strategies to Reduce Impacts	42
5.1	Introduction	42
5.2	General Measures	43
5.3	Safety and Environmental Standards and Programmes	45
5.4	Adherence to Designated Routes	46
5.5	Delivery Scheduling and Retiming	46

5.6	Use of Holding Areas and Consolidation Centres	47
5.7	Measures to Encourage Sustainable Freight	47
5.8	Material Procurement Measures	48
5.9	Collaboration with Other Sites in the Area	49
5.10	Implement a Workforce Travel Plan	49
6	Preliminary Construction Vehicle Movements	51
6.1	Vehicle Forecasts	51
6.2	Construction Vehicle Types	54
7	Implementing, Monitoring and Updating	56
7.1	Management	56
7.2	Monitoring and Review	56
	Appendix A Context Maps	
	Appendix B Preliminary Construction Programme	
	Appendix C Preliminary Phasing Plans	
	Appendix D Construction Traffic Routing Maps	
	Appendix E PRow Crossings	
	Appendix F Construction Traffic Forecasts	

Table of Figures

Figure 1.1: Project Location Plan	9
Figure 2.1: Existing Local Transport Connections	16
Figure 2.2: Indicative Location of New Access Road	18
Figure 4.1 Principal Construction HGV Access Routes (refer to Appendix D for larger version)	35
Figure 4.2 Local Construction HGV Access Routes (refer to Appendix D for larger version)	37
Figure 6.1 Forecast of monthly construction vehicle arrivals	51
Figure 6.2 Forecast of monthly workforce vehicle arrivals	52
Figure 6.3 Combined monthly forecast for construction deliveries and workforce vehicles	52

Table of Tables

Table 3.1 Indicative Construction Phasing	22
Table 5.1 Planned Measures to Reduce Construction Impact	42
Table 6.1 Peak construction traffic by year	53
Table 6.2 Indicative Construction Vehicle Types for each Stage of the Works	54

1 Introduction

1.1 Preamble

- 1.1.1 Buro Happold has been appointed by North Lincolnshire Green Energy Park Limited (the Applicant) to provide transportation and highways advice in relation to North Lincolnshire Green Energy Park (NLGEP) ('the Project') in Flixborough, North Lincolnshire.
- 1.1.2 The proposals comprise a Nationally Significant Infrastructure Project (NSIP), which requires approval by the Planning Inspectorate (PINS) on behalf of the Secretary of State.
- 1.1.3 This Construction Logistics Plan has been submitted in support of the Development Consent Order (DCO) application and assesses the transportation impacts of The North Lincolnshire Green Energy Park (NLGEP) ('the Project'). It forms part of a suite of technical documents that have been submitted with the DCO application, including the Environmental Statement (ES), outline Transport Assessment (TA) and Travel Plan (TP).

1.2 DCO Application Description

- 1.2.1 The North Lincolnshire Green Energy Park (NLGEP) ('the Project'), located at Flixborough, North Lincolnshire, is a Nationally Significant Infrastructure Project (NSIP) with an Energy Recovery Facility (ERF) capable of converting up to 760,000 tonnes of non-recyclable waste into 95 MW of electricity at its heart and a carbon capture, utilisation and storage (CCUS) facility which will treat the excess gasses released from the ERF to remove and store carbon dioxide (CO₂) prior to emission into the atmosphere.
- 1.2.2 The NSIP incorporates a switchyard, to ensure that the power created can be exported to the National Grid or to local businesses, and a water treatment facility, to take water from the mains supply or recycled process water to remove impurities and make it suitable for use in the boilers, the CCUS facility, concrete block manufacture, hydrogen production and the maintenance of the water levels in the wetland area.
- 1.2.3 The Project will include the following Associated Development to support the operation of the NSIP:
- a bottom ash and flue gas residue handling and treatment facility (RHTF)
 - a concrete block manufacturing facility (CBMF)

- a plastic recycling facility (PRF)
 - a hydrogen production and storage facility
 - an electric vehicle (EV) and hydrogen (H₂) refuelling station
 - battery storage
 - a hydrogen and natural gas above ground installation (AGI)
 - a new access road and parking
 - a gatehouse and visitor centre with elevated walkway
 - railway reinstatement works including, sidings at Dragonby, reinstatement and safety improvements to the 6km private railway spur, and the construction of a new railhead with sidings south of Flixborough Wharf
 - a northern and southern district heating and private wire network (DHPWN)
 - habitat creation, landscaping and ecological mitigation, including green infrastructure and 65 acre wetland area
 - new public rights of way and cycle ways including footbridges
 - Sustainable Drainage Systems (SuDS) and flood defence; and
 - utility constructions and diversions.
- 1.2.4 The Project will also include development in connection with the above works such as security gates, fencing, boundary treatment, lighting, hard and soft landscaping, surface and foul water treatment and drainage systems and CCTV.
- 1.2.5 The Project also includes temporary facilities required during the course of construction, including site establishment and preparation works, temporary construction laydown areas, contractor facilities, materials and plant storage, generators, concrete batching facilities, vehicle and cycle parking facilities, offices, staff welfare facilities, security fencing and gates, external lighting, roadways and haul routes, wheel wash facilities, and signage.
- 1.2.6 The limits of the land covered by the DCO ('the Order Limits') are shown on Figure 1.1. The land within the Order Limits is known as the 'Application Land'. Figure 1.1 also shows the main buildings of the Project located north of the B1216 Ferry Road West (collectively known as 'the Project including the ERF; carbon capture, utilisation and storage facility; bottom ash and flue gas residue handling and treatment facility; concrete block manufacturing facility; plastic recycling facility; hydrogen production and storage facility; electric vehicle (EV) and hydrogen (H₂) refuelling station; battery storage and hydrogen and natural gas above ground installations).

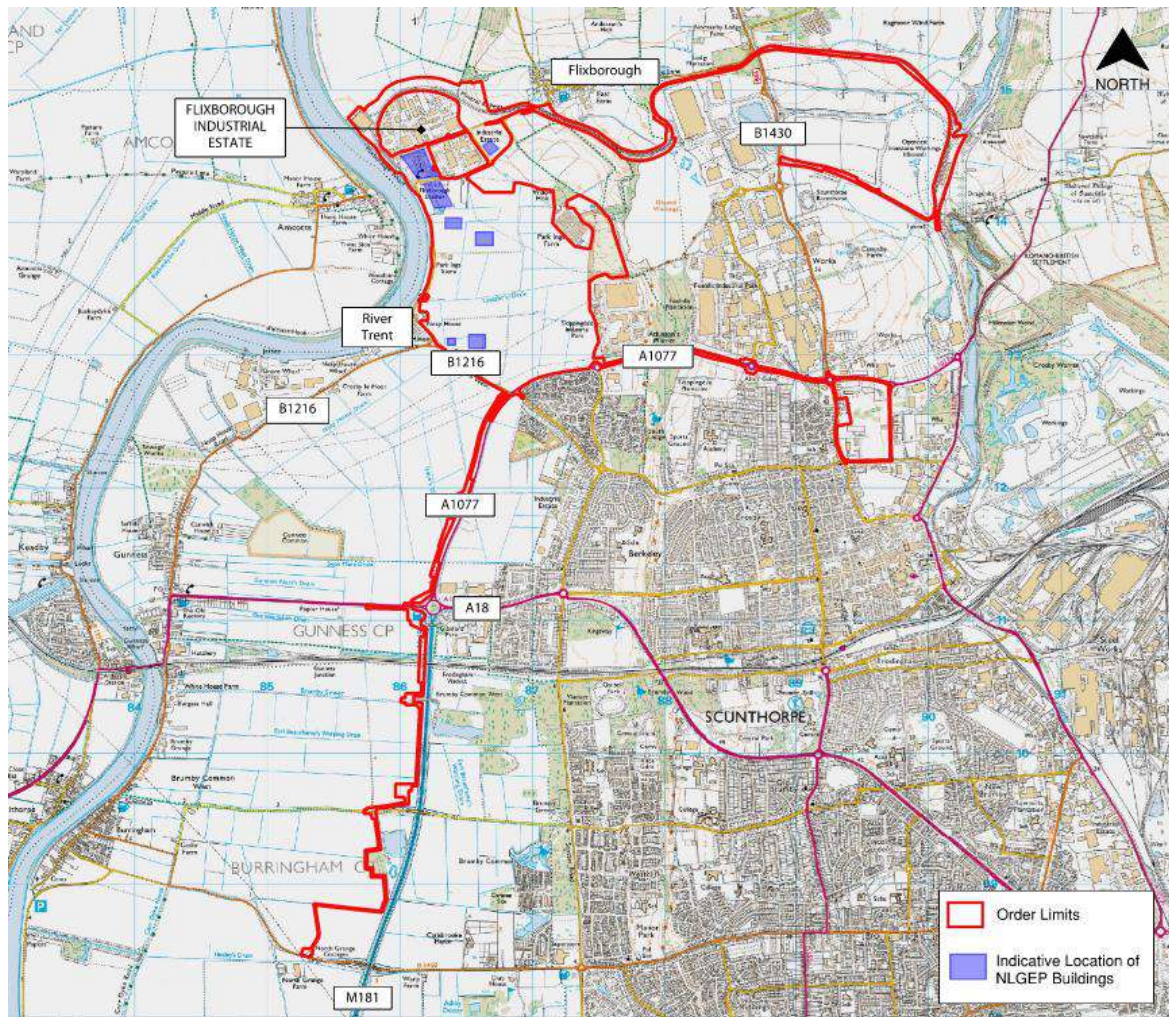

Figure 1.1: Project Location Plan

1.3 CLP Purpose and Objectives

1.3.1 This Outline Construction Logistics Plan (CLP) serves to provide an overview of the expected logistics activity and management thereof during the construction project for North Lincolnshire County Council (NLC) as local highway authority and National Highways (formerly Highways England) who are the highway authority responsible for the strategic highway network (M180 /M181). Should planning permission be granted, it is envisaged that the Applicant will be required to produce a Detailed CLP for submission and approval by NLC prior to commencement of works.

1.3.2 The objectives of the CLP are to reduce:

- environmental impact of construction activities through lower vehicle emissions and noise levels, and through the efficient use of on-site resources and co-working with other developments in the area
- risks to road users, specifically in relation to construction vehicle movements to and from the site
- congestion, by reducing the number of vehicle trips, particularly in peak periods; and
- cost, through efficient working practices and reduced deliveries.

1.3.3 To support the delivery of these objectives the Applicant will encourage the following measures to be adopted by the project's contractor and associated sub-contractors:

- encourage construction workers to travel to the site by non-car modes
- promote smarter operations that reduce the need for travel or that reduce or eliminate trips in peak periods
- encourage the use of sustainable freight modes of travel
- encourage the use of greener vehicles
- manage the on-going development and delivery of the CLP with contractors and sub-contractors
- communicate measures contained within the CLP to workers and suppliers; and
- encourage environmentally friendly use of construction freight vehicles.

1.4 CLP Structure

1.4.1 The CLP has been prepared following the best practice structure established in the CLOCS Construction Logistics Plan Guidance, as follows:

- **Introduction**
- **Context, considerations and challenges** – includes policy context and the existing transport baseline conditions regarding the pedestrian and cycle networks, public transport facilities (National Rail, buses, etc) and the highway network
- **Construction programme and methodology** – an overview of the expected phasing, timescales and estimated vehicle movements associated with the works
- **Vehicle routing and site access** – routes to be used by Heavy Goods Vehicles (HGVs) at regional and local level
- **Strategies to reduce impacts** – setting out the key methods to manage and mitigate the impact of construction traffic

- **Preliminary construction vehicle movements;** and
- **Implementing, monitoring and updating** - an overview of how the CLP will be managed and monitored.

2 Context, Considerations and Challenges

2.1 Policy Context

Department for Transport Strategic Road Network Guidance (DfT Circular 02/2013)

- 2.1.1 Department for Transport (DfT) Circular 02/2013 'The Strategic Road Network and the Delivery of Sustainable Development sets out the way in which National Highways (formerly Highways England) "will engage with communities and the development industry to deliver sustainable development and, thus, economic growth, whilst safeguarding the primary function and purpose of the strategic road network."
- 2.1.2 National Highways is responsible for operating, maintaining and improving the Strategic Road Network in England.
- 2.1.3 DfT Circular 02/2013 is guided by the Government's core objective of providing "safe roads, reliable journeys, informed travellers". It expects initiatives to be put forward to manage the traffic impact of the proposed development and support the promotion of sustainable transport, which would be expected to include a robust travel plan.
- 2.1.4 DfT Circular 02/2013 also states that all environmental implications associated with the proposed development should be adequately assessed in accordance with prevailing policies and standards. This requirement applies to the environmental impacts arising from the temporary construction works as well as the permanent / operational situation.

Traffic Management Act (2004)

- 2.1.5 Local authorities have a responsibility to manage traffic networks within their area. This requirement is set out in Part 2 of the Traffic Management Act (TMA). Local authorities have a duty ensure that traffic moves freely and quickly on their roads and the roads of nearby authorities. The TMA gives councils more tools to manage parking policies, coordinate street works and enforce some moving traffic offences.

North Lincolnshire Local Plan (2003)

- 2.1.6 The Project is located within the administrative district of North Lincolnshire Council, which is a unitary authority.

2.1.7 The North Lincolnshire Local Plan (adopted in May 2003) has been replaced by the Local Development Framework (discussed later in this section) but most policies from this Local Plan have been saved including the key transport-related policies summarised below:

- **T14 The North Lincolnshire Strategic Road Network (NLSRN):** Traffic should be directed onto the roads in the North Lincolnshire area that are most able to accommodate it. Inter urban traffic in this area is predominantly routed via the M180/M181 and A1077.
- **T15 Highway Improvements and New Highway Construction:** Where new highway infrastructure is being developed, a balance must be struck between restricting environmental impacts associated with construction and operation and the overall community benefits of the scheme.
- **T22 Rail Freight:** The use of rail for goods traffic will be encouraged.
- **T23 Water Freight:** Water transport represents an efficient means of moving a variety of freight cargoes. North Lincolnshire is well-sited to take advantage of water freight opportunities due to the wharf facilities sited on the Rivers Trent and Humber. There is scope for industry to capitalise on these facilities.
- **T24 Road Freight:** The environmental impact of moving freight by road will be reduced by concentrating lorries onto the North Lincolnshire Strategic Road Network, by banning heavy goods vehicles from sensitive areas, by encouraging the development of rail freight facilities and encouraging the use of the waterways. Where transporting freight by road is the only feasible option, the Council will seek to develop measures to mitigate the adverse impact of these vehicles where necessary.

North Lincolnshire Local Development Framework – Core Strategy (2011)

2.1.8 This Core Strategy sets out North Lincolnshire’s long-term spatial planning framework for the development of North Lincolnshire up to 2026. North Lincolnshire’s vision is to become the Global Gateway for the north of England. Whilst it is their ambition to grow North Lincolnshire, the main priority is to ensure that all developments are sustainable and complement and enhance the area’s high quality natural and built environment without any detrimental impact.

2.1.9 The M180/M181 roads are specifically included within a list of ‘main road links’ forming the area’s Strategic Communications Network, linking the area to the rest of the Yorkshire and Humber region and beyond.

Emerging North Lincolnshire Local Plan (2021)

- 2.1.10 North Lincolnshire Council is preparing a new Local Plan to provide guidance for development to 2036. This new Local Plan is intended to replace the saved policies from the adopted Local Plan and the Local Development Framework. The emerging Local Plan is expected to be adopted in late 2022 or early 2023.
- 2.1.11 It includes policies to safeguard existing freight infrastructure, including disused railway lines with a reasonable prospect for re-use, to encourage sustainable freight options and to provide for road freight through the provision of lorry parking sites and HGV route management.

Planning for Renewable Energy Development Supplementary Planning Document (2011)

- 2.1.12 This Supplementary Planning Document (SPD) sets out North Lincolnshire Council's approach to planning for renewable energy. Policy 13 sets out requirements in relation to Highways and Rights of Way:
- 2.1.13 Policy 13 - Developers should consider access to proposed sites for renewable energy development from the earliest stages in putting together proposals. All proposals should be accompanied by an assessment of the full access route to the site, which should meet the requirements of the highway authority. Where appropriate mitigation measures should be identified.
- 2.1.14 It is noted that these requirements are primarily concerned with abnormal and indivisible loads (AILs) associated with wind-turbines, but the requirements are applicable across other types of development.

2.2 Initiatives and Guidance

Freight Operator Recognition Scheme (FORS)

- 2.2.1 The Fleet Operator Recognition Scheme (FORS) is a voluntary accreditation scheme, which aims to raise the level of quality within fleet operations, and to demonstrate which operators are achieving exemplary levels of best practice in safety, efficiency, and environmental protection.
- 2.2.2 FORS is a unique, industry-led, membership (bronze, silver, gold) scheme to help van and lorry operators in London become safer, more efficient and more environmentally friendly. The scheme offers a number of benefits including advice, training and discounted breakdown assistance.

- 2.2.3 Bronze accreditation confirms that you employ good practice and comply with the requirements laid out by the FORS Standard. This includes demonstrating dedication to driver and vehicle safety, combined with improving operating practices through effective monitoring of fuel and tyre usage.
- 2.2.4 By achieving FORS Silver accreditation the vehicle fleet will be compliant with the Construction Logistics Community Safety (CLOCS) Standard and with TfL's WRRR (Work Related Road Risk), which is a freight safety initiative aligned with the Mayor's Vision Zero approach to road danger reduction.
- 2.2.5 FORS Gold accreditation is only awarded to exceptional operators who have met challenging targets. FORS Gold operators will actively promote the FORS Standard to their supply chain and produce a case study documenting their progression through to the top level of accreditation.

CLOCS Construction Logistics Plan Guidance

- 2.2.6 The Construction Logistics and Community Safety (CLOCS) organisation published their 'Construction Logistics Plan Guidance' in 2018, the purpose of which is to ensure that high quality CLPs are produced which act to minimise the impact of freight movement on the road network. The guidance focuses on reducing the impact of construction in terms of:
- environmental impact: lower vehicle emissions and noise levels
 - road risk: improving the safety of road users
 - congestion: reduced vehicle trips, particularly in peak periods; and
 - cost: efficient working practices and reduced deliveries.
- 2.2.7 CLPs provide a framework for understanding and managing construction vehicle activity into and out of a construction site and should detail:
- the amount of construction traffic generated
 - the routes the construction vehicles will use and consideration of local impacts; and
 - any traffic management that will be in place.
- 2.2.8 The guidance suggests a range of measures and strategies that should be considered to reduce the impact of construction on the local environment.

2.3 Local Access Context

2.3.1 The Application Land is located at land within and to the south of Flixborough Industrial Estate, to the west of Scunthorpe, North Lincolnshire. The Order Limits encompass an area within and adjacent to Flixborough Port (RMS Trent Ports) on the east bank of the River Trent.

2.3.2 The Order Limits also encompass works to install district heating and private wire networks (DHPWN) and to reinstate the disused freight railway line from Dragonby sidings to Flixborough Industrial Estate and the Port (refer to Figure 1.1).

2.3.3 Figure 2.1 provides an illustration of the main transport links in the immediate vicinity of the Application Land and these are discussed further below).

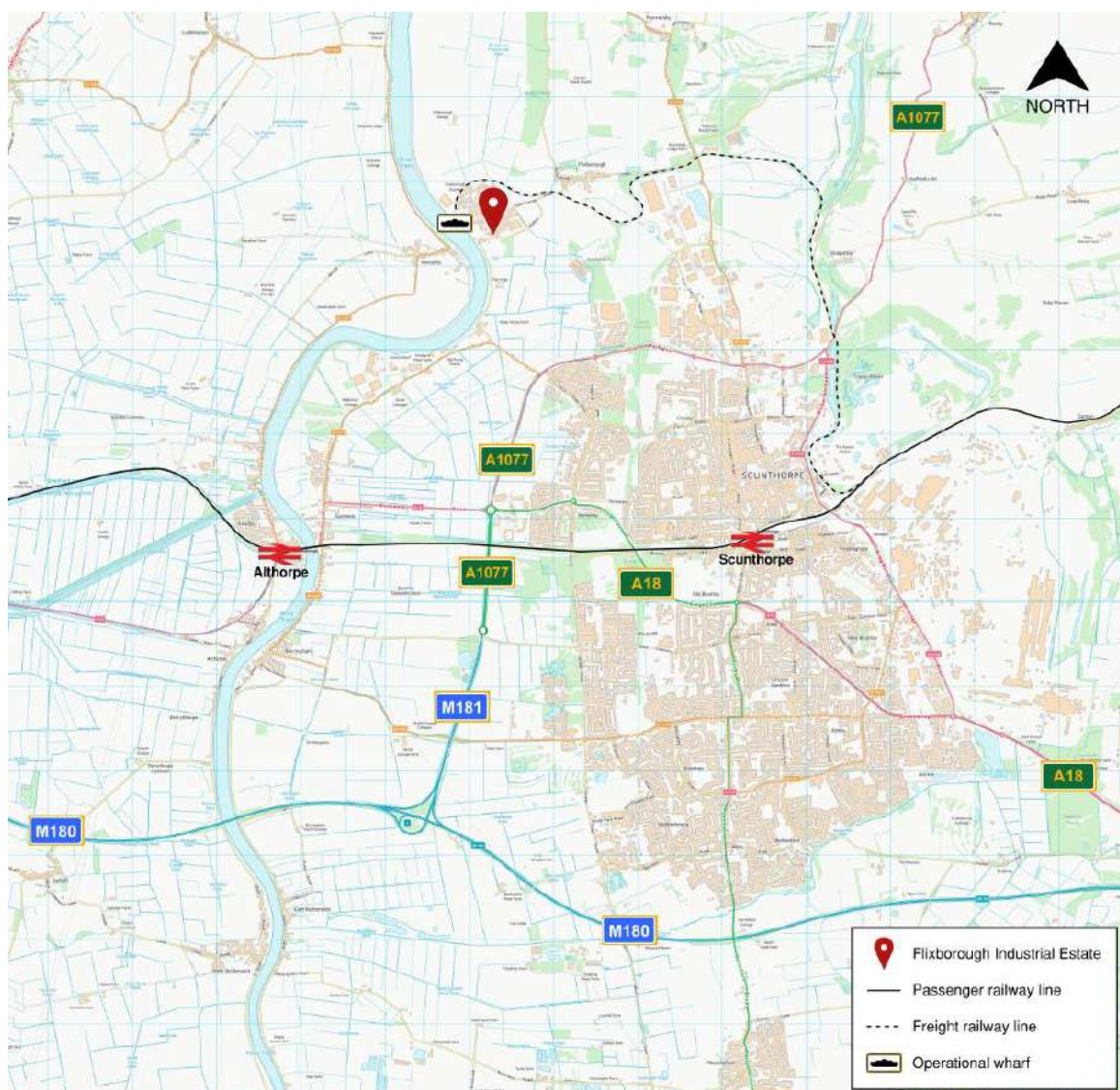

Figure 2.1: Existing Local Transport Connections

Highway Access

- 2.3.4 The Project is conveniently placed for access to the North Lincolnshire Strategic Road Network (NLSRN) and is only a short distance from the M180 and M181, which provide connectivity to the wider motorway and trunk road network and to the regionally important Immingham docks c.30km to the east.
- 2.3.5 From the M181, the Application Land is currently accessed by following the A1077 northbound and then turning left onto the B1216 (Ferry Road West). After approximately 500m, a roundabout provides access to Stather Road, which follows the River Trent northwards to the Port and Flixborough Industrial Estate that are adjacent to the proposed ERF. Refer to the context maps in Appendix A for further detail of the existing highways access.
- 2.3.6 As part of the DCO, highway improvements are proposed, including the construction of a New Access Road between the B1216 Ferry Road West and the northern section of Stather Road. The intention is that this New Access Road would serve the Project, as well as the existing Flixborough Industrial Estate and Port area. It seeks to provide improved road connectivity and removes the need for HGVs to use the southern section of Stather Road via Neap House, which is very narrow and generally unsuitable for two-way HGV movements. The location of the New Access Road is shown indicatively below in Figure 2.2).
- 2.3.7 In order to facilitate the proposed ERF development, it is intended to stop up Stather Road between Neap House and Flixborough Industrial Estate (as indicated on Figure 2.2) and any existing traffic using Stather Road will relocate to the New Access Road.
- 2.3.8 This New Access Road would be implemented before the main construction works start on site, to enable construction traffic to use this as their route to/from the Project Land throughout the majority of the construction phase (refer to Section 3 for construction phasing details).
- 2.3.9 As part of the Lincolnshire Lakes development, a new roundabout has been constructed on the M181, to the north of Brumby Common Lane, located approximately 2km north of the M180. Whilst the east-west approaches at the roundabout are in place, these are not currently in use but will become operational once the Lincolnshire Lakes development is completed. As part of these works, the section of road between this new roundabout and the A18 to the north has been downgraded from a trunk road (M181) to normal highway (A1077) under NLC's control.

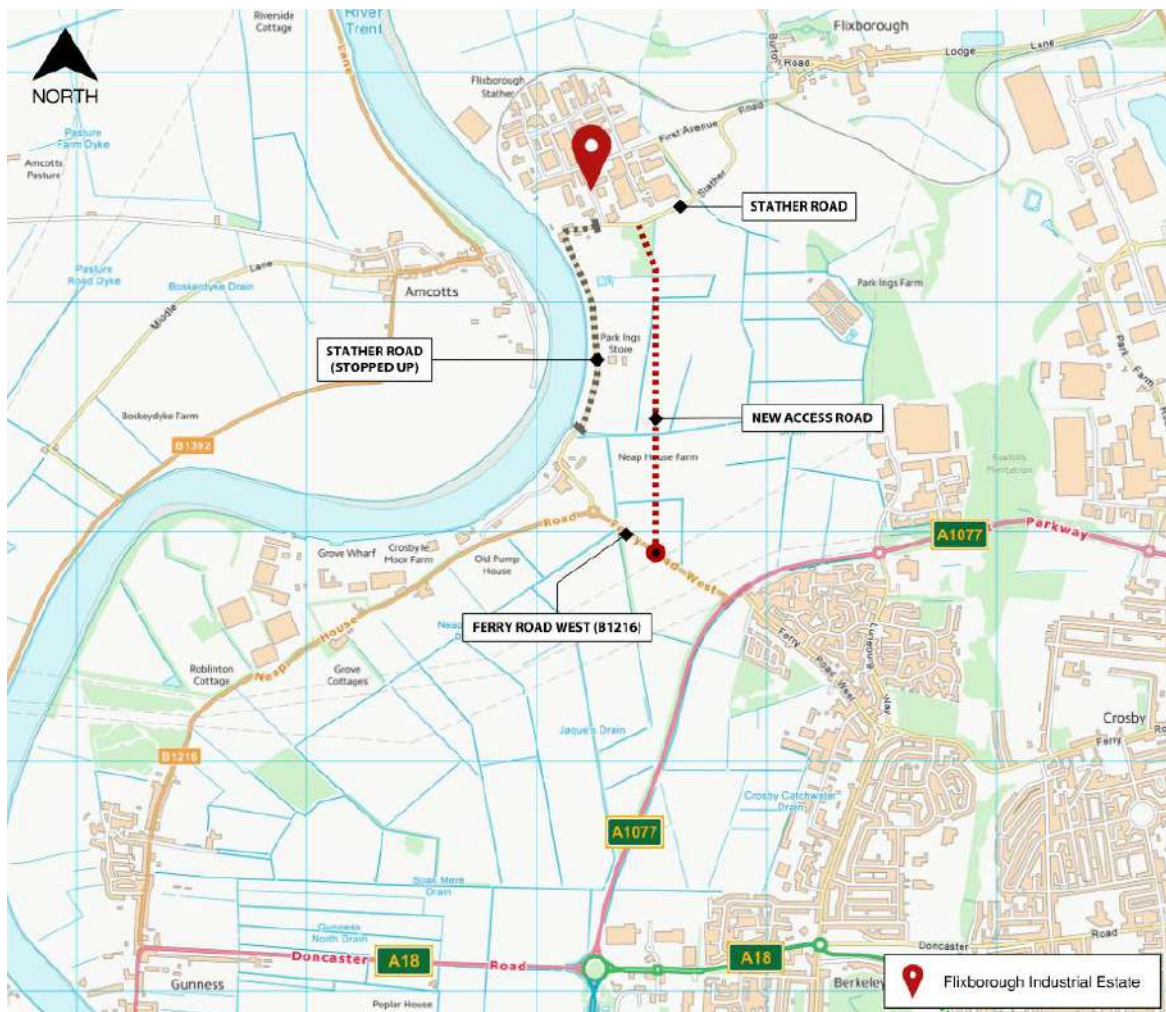

Figure 2.2: Indicative Location of New Access Road

Bus Accessibility

- 2.3.10 At present the nearest bus route serving the Application Land (Bus Route 60) runs along Stather Road adjacent to Flixborough Industrial Estate / Flixborough Port. Bus Route 60 runs north-south from Whitton via Burton upon Stather and Flixborough to Scunthorpe bus and rail stations and then John Leggott sixth form college situated to the south of Scunthorpe town centre.
- 2.3.11 The 'Flixborough Stather Wharf' bus stops are situated on Stather Road adjacent to the Flixborough Port access. There is no physical bus infrastructure provided at this location (such as bus stops etc) as this bus route forms part of NLC's rural bus network, which operates an on-demand bus service via 'JustGo North Lincs'.

2.3.12 The 'JustGo North Lincs' on demand bus service allows passengers to book and pay online for their bus journey through the JustGo mobile app, as well as choosing where they get picked up from. The service can be booked up to 30 days in advance up until the day of departure.

2.3.13 As part of the proposal to stop up Stather Road between Neap House and Flixborough Industrial Estate, Bus Route 60 will be diverted via the proposed New Access Road.

2.3.14 There are additional bus services (Routes 7 and 8) available via Ferry Road West with bus stops located approximately 90 metres south of the A1077. These bus stops are within a 10-minute cycle ride / 30-minute walk of the Application Land.

Rail Accessibility

2.3.15 Althorpe railway station is the nearest station serving the Project, which is located approximately 4.3 kilometres south-west of the Application Land on the opposite side of the River Trent, adjacent to Keadby Bridge. It is approximately 20-minute cycle ride via Stather Road and the B1216 Neap House Road.

2.3.16 Scunthorpe railway station is located a short walk from Scunthorpe town centre, which is approximately 4.5 kilometres south-east of the Application Land and can be reached by bus (approximately 15 to 20-minute bus journey) or by cycle (approximately 30-minute cycle ride).

2.3.17 Scunthorpe and Althorpe stations are both served by Northern Trains (NT) and the TransPennine Express (TPE).

2.3.18 Scunthorpe station has two platforms, Platform 1 serves mainly TPE eastbound trains towards Grimsby / Cleethorpes with some NT westbound services towards Doncaster. All westbound TPE services, and most NT services use Platform 2. There is an hourly TPE service eastward to Cleethorpes and westbound there in an hourly TPE service to Manchester Piccadilly and Manchester Airport. with an hourly local NT service calling at all intermediate stations towards Doncaster. Trains operate throughout the week (Monday to Sunday).

2.3.19 Scunthorpe station has step free access from the station entrance to all platforms.

2.3.20 Althorpe railway station is mainly served by NT, which operates east-west from Scunthorpe via Althorpe, Crowle to Doncaster and onward connections to Sheffield. There are also occasional TPE services via this station. Train services operate Monday to Saturday with an hourly service.

2.3.21 Althorpe station has two platforms, Platform 1 (Eastbound) and Platform 2 (westbound) and the station does not currently provide step free access with Platform 1 only accessible by a footbridge with steps.

Walking and Cycling

2.3.22 Existing pedestrian and cycle infrastructure connecting to the Application Land is currently somewhat limited but the DCO application includes highway improvements in the area, which will improve pedestrian and cycle connectivity to/from the Application Land.

2.3.23 It is considered unlikely however that walking and cycling would provide realistic travel choices by the construction workforce at this location and given the need to carry personal protective equipment (PPE) and other tools and equipment. Thus, walking and cycling accessibility has not been described further here (please refer to the Transport Assessment for further detail).

2.4 Freight Transport

2.4.1 As part of the DCO application, it is proposed to re-open the disused railway spur that runs eastwards from Flixborough Port and connects to the railway sidings at Dragonby, located east of Scunthorpe and to provide a new railhead at Flixborough Port. This could enable the railway to be used for freight transport to/from the site and this has been considered as part of the Rail Assessment report submitted as part of the Preliminary Environmental Information Report (PEIR).

2.4.2 In addition, due to the Project's strategic location adjacent to the River Tyne, there is an opportunity to adopt river-based transport of freight. A Navigational Risk Assessment (NRA) has been undertaken, which assesses the level of service and level of safety for vessels on the River Tyne. It is understood that during the construction phase, some of the fill material could be imported via the River and that the anticipated increase in vessel movements could be accommodated at Flixborough Wharf without any alterations being required.

2.4.3 The potential use of the railway and/or river to support construction logistics is still under consideration (this is discussed in more detail in Section 5.7).

2.5 Considerations and Challenges

2.5.1 The Project is located close to strategic motorway routes, with the M181 and M180 providing access to the M18 and M62 which, in turn, connect to routes including the M1 and M6. These routes are generally well suited to accommodating HGV construction traffic.

2.5.2 The main challenges/considerations identified at this stage are as follows:

- **Local access constraints:** until the New Access Road is constructed, access for HGVs will be via the existing Stather Road route from the B1216. At Neap House, this route is subject to traffic-signal control as the road is not suitable for two-way HGV movements through the village. This route is not considered suitable for a high volume of sustained HGV activity and therefore the proposals seek to construct the New Access Road from the B1216 prior to major works commencing. Construction traffic will also not be permitted to approach the Application Land from the north-east via Flixborough village due to the existing 7.5t weight-restriction along this route, making it unsuitable for HGVs.
- **High volume of imported construction materials:** due to the need to raise site levels for flood defence purposes, the works will include the import of a high volume of fill materials, resulting in a significant number of HGV movements. This work is programmed to commence only after completion of the New Access Road to avoid the need to route HGVs via Stather Road.
- **Temporary traffic management:** measures will be required at several locations, particularly during construction of the New Access Road, its junction with the B1216, reconfiguration of 'internal' roads within the Order Limits and during installation of utilities infrastructure, including the district heating and private wire network. It will be important to minimise disruption to access for neighbouring properties and will involve production of detailed phasing plans which will require approval with relevant stakeholders. It is likely that pedestrian routes may need to be temporarily diverted as part of the traffic management measures.

3 Construction Programme and Methodology

3.1 Programme and Phasing

- 3.1.1 This section sets out the indicative construction programme and phasing for the Project within the Order Limits; this programme is only provisional at this stage and will be dependent on a range of factors including appointment of the various contractors associated with each stage of works. The construction phasing and programme will be developed in more depth for the Detailed CLP, which will be submitted prior to commencement of the works.
- 3.1.2 The preliminary programme is included in Appendix B; it is anticipated that works would start in 2023 and be completed after approximately six years.
- 3.1.3 The programme assumes a number of main overlapping phases of activity, which are summarised below. Preliminary phasing plans have been prepared to illustrate this approach to phasing and these are included in Appendix C.

Table 3.1 Indicative Construction Phasing

Phase	Period
Phase 1 – Establishment and Site Access	Q1 2023 – Q3 2025
Phase 2 – Energy Recovery Facility (ERF)	Q3 2023 – Q2 2027
Phase 3 – Residue Handling and Treatment Facility	Q3 2024 – Q4 2025
Phase 4 – Electric Vehicle (EV) and Hydrogen Refuelling Station	Q1 2025 – Q1 2026
Phase 5a – Concrete Block Manufacturing Facility	Q2 2025 – Q2 2026
Phase 5b – Plastic Recycling Facility	Q2 2027 – Q3 2028 *
Phase 6 – District Heating and Private Wire Network	Q3 2026 – Q4 2028 *

* Note – Phase 6 commences before Phase 5b

Phase 1 – Establishment and Site Access

- Establish main Contractor's compound on existing hard standing, south of Stather Road; in parallel, relocate RMS Ports to the northern part of their ownership boundary and establish their main access off First Avenue
- Establish secondary Contractor's compound to the north-east of the proposed new junction on the B1216
- Demolition contractor to set up on former Bellwin House land
- Commence site clearance and demolition work for the Energy Recovery Facility
- Establish Dragonby Sidings construction compounds and commence railhead construction/rail upgrade

- Commence new roundabout construction on B1216, including the new shared pedestrian / cycle footway connections along the B1216 and proposed junction alterations at the A1077 / B1216 signal junction
- Commence clearance and construction of New Access Road from B1216 to Stather Road (south to north), including utility corridors and the new junction arrangement at its northern end with Stather Road; install section of District Heating and Private Wire Network along new access road at this point
- Commence new electrical grid connection and private wire network; commence earthworks for electrical switchyard infrastructure
- Carry out any service diversion
- Construct internal access road around residue handling and treatment facility and concrete block manufacturing facility buildings
- Construction of gatehouse and visitor centre
- Construct temporary car park
- Construction of attenuation ponds, swales and realignment of ditches
- Advance planting and ecology works
- Undertake earthworks and establish temporary construction welfare facility; and
- Clearance of existing vegetation and construction of flood bund around chicken farm, along First Avenue and within the wetlands.

Phase 2 – Energy Recovery Facility (ERF)

- New access road adopted
- Import, place and compact fill material
- Pile foundations
- Construct ground slab/turbine and boiler blocks
- Construct access ramp
- Construct superstructure
- Fit out and commission; and
- Construct electrical substation infrastructure.

Phase 3 – Residue Handling and Treatment Facility (RHTF)

- Clear site for bottom ash and flue gas residue handling and treatment facility (RHTF)
- Import/place/compact fill material
- Pile foundations

- Construct ground slab
- Construct superstructure; and
- Fit out and commission.

Phase 4 – Electric Vehicle (EV) and Hydrogen Refuelling Station

- Clear site for an electric vehicle (EV) and hydrogen (H₂) refuelling station, a hydrogen and natural gas above ground installation (AGI), a hydrogen production and storage facility and battery storage
- Import/place/compact fill material
- Pile foundations
- Construct ground slab
- Construct superstructure
- Fit out and commission; and
- Construct hydrogen and natural gas above ground installation (AGI).

Phase 5 - Concrete Block Manufacturing Facility (CBMF) and Plastic Recycling Facility (PRF)

- Establish temporary construction compound for CBMF and PRF
- Clear sites for the concrete block manufacturing facility and plastic recycling facility
- Import/place/compact fill material
- Pile foundations
- Construct ground slab
- Construct superstructure
- Fit out and commission; and
- Construct elevated walkway.

Phase 6 – District Heating and Private Wire Network

- Establish temporary construction compounds
- Commence site clearance on agreed route (easement)
- Install district heating and private wire networks and reinstate; and
- Commission.

3.1.4 It is noted that Phases 5 and 6 commence before Phase 4.

3.2 Methodology

Pre-commencement Ecological and Environmental Mitigation

- 3.2.1 An indicative construction strategy and phasing plan has been created to support the assessment of construction related environmental impacts. The Project will be indicatively constructed over a six-year period in six phases as outlined above. An Indicative Phasing Plan has been produced but the final phasing will be submitted to the local planning authority for approval.
- 3.2.2 Prior to the commencement of all construction and demolition activities within the Application Land, all mitigation measures required in advance of construction as identified in the environmental assessment will be put in place. These mitigation measures will be monitored (by a clerk of works) on a regular basis and at the start of the main phases of the development. The sequence of construction works may have to be aligned with those aspects of the environmental assessment that cannot be relocated or protected due to seasonal parameters. All ecological mitigation will remain in place until the completion of the particular phase of the works
- 3.2.3 A Soil Management Plan (SMP) will be established as part of the pre-commencement conditions and in accordance with the EIA. This strategy will identify the removal, segregation, and organised stockpiling of excavated material across the whole Project. Based on the outcome of the material assessment, areas within the Order Limits will be identified for stockpiling of topsoil, clay, reclaimed construction material and material unsuitable for reuse on the Project, which will be removed from the land within the Order Limits. The unsuitable material will be managed in accordance with the Construction Waste Management Plan (WMP).
- 3.2.4 Based on the design of the sustainable drainage system (SuDS) for the Project, detention basins, retention ponds and swales will be constructed. These works will take place at various points during the Project delivery but will be completed and landscaped by the time the ERF is commissioned. The SuDS will be integrated into the existing surface water drainage system and feed to the existing surface water pumping station located north of Neap House.

Contractor's Compound and Site Set-Up

- 3.2.5 A number of contractor's compounds and lay down areas are required within the Order Limits for the construction of the Project.
- 3.2.6 The contractor's compound and lay down area for the ERF will be located to the south of Stather Road. The main office and welfare facilities will be located to the southern part of the contractor's compound, and the full extent of this area will be secured by Heras fencing.

- 3.2.7 California Bearing Ratio tests (CBR) will be carried out on the existing land to determine the locations for the laydown of large, heavy items required in the construction of the Energy Recovery Facility (ERF). The main access to the contractors' compound will be via Stather road until the new access road has been constructed. Where possible temporary connections into the existing services will be created; if not, then a stand-alone facility will be constructed, which will be decommissioned when the Project is complete, and the contractor's compound removed.
- 3.2.8 A second contractor's compound will be established to the southern part of the development area close to the B1216 and will be in the location of the proposed electric charging/hydrogen filling station. This compound will serve the main access road construction between the B1216 and Stather Road. This compound will provide the offices and welfare facilities for the contractors constructing the new access road between the B1216 and Stather Road. This compound will be sized to accommodate the earth moving vehicles and estimated workforce required to construct the access road. All sub-base material used in the construction of the compound will be utilised in the construction of the charging/filling station.
- 3.2.9 Compounds required to deliver the DHPWN will be secured using Heras fencing and the topsoil will be stripped and stockpiled for the reinstatement of the compound. Type 1 sub-base will be placed to form the working platform and site offices and welfare facilities will be established. As the DHPWN progresses the compounds will be removed after the completion of that section. The compounds will then be fully reinstated.
- 3.2.10 For the rail replacement/refurbishment, a contractor's compound will be established at Dragonby Sidings. This compound will be secured using Heras fencing to isolate it from the operations at the sidings. All replacement/refurbishments works on the railway will be served from this compound. Satellite welfare facilities will be required along the route of the railway which will be located within the Order Limits.

Demolition Works

- 3.2.11 There are a number of buildings and structures that will require demolition prior to the commencement of the ERF. These buildings and structures will likely be demolished at the beginning of the first phase of construction when construction compounds are being established. The demolition contractor's compound will be set up on the site of the former Glanford House, and the area of RMS Ports, which contains the four large storage sheds to be demolished, will be securely fenced off in accordance with the Construction (Design and Management) Regulations 2015.

3.2.12 Any environmental/ecological conditions required will be discharged prior to the commencement of the demolition works. Sack filters will be applied to the access points of the surface water drainage system. Cladding will be removed from each shed, followed by the dismantling of the steel frame structure, all of which will be recycled on site where possible or transported off-site for recycling. The existing foundations will be broken up along with the existing hard standing area. Any hazardous material will be removed from the site. Recycling and disposal of materials will be undertaken in accordance with the Construction WMP. Material that is considered reusable in the construction of the ERF or associated works will be stockpiled in accordance with the SMP (appended to the Code of Construction Practice).

Service Diversions and New Services

3.2.13 There are a number of existing services that will be located and diverted in the process of delivering the Project. These service diversions will be carried out in the first phase of the Project (year 1) when the alignment of the new access road and associated junctions are being constructed. The majority of the diversions will involve exposing the existing service and establishing the new route. The services will be directly buried and marked in accordance with best practice.

3.2.14 Where new and existing services are present, especially around the new access road, then ducts will be installed to accommodate all proposed services. Services will be installed within the access road corridors for those parts of the Project that will be delivered after the commissioning of the ERF, such as the district heat network, private wire network and communications network.

3.2.15 The service corridors on either side of Stather Road and First Avenue adjacent to Flixborough Industrial Estate will require close coordination, especially as the ERF export cables must be routed to the main switchyard, which is located to the east of the industrial estate. If a gas supply is provided to the ERF, then the pipeline from the AGI to the ERF will need to be located on the opposite side of the road to the main export cables.

3.2.16 Services diversions/installations are likely to require localised temporary lane closures and traffic management.

New Access Road

3.2.17 Following the implementation of any advanced environmental mitigation which may be required, the main alignment of the access road will be established. This alignment will cross several surface water / drainage features that will have to be addressed.

- 3.2.18 This will be carried out by the installation of pipes or culverts based on the flow rate and capacity of the watercourse. For larger watercourses, box culverts or bridges will be inserted by damming the upstream section and over-pumping whilst excavating and installing the culvert/bridge sections together with headwalls. The surface features will be carried out in advance of the main road construction progress.
- 3.2.19 Based on the findings of the ground investigation, the road corridor will be stripped of topsoil and stockpiled in a suitable location for reuse following construction. The road corridor will then be excavated to the formation level as designed; this will also include the service corridors that will run on either side of the road. Imported sub-base will be placed in layers and consolidated to the correct ground bearing capacity. The surface water drainage, concrete kerbs and service ducts will be installed and cast in place. The tarmac base course will then be laid, followed by the wearing course. Whilst the road formation is being laid, the street furniture (lamp posts, manhole covers, duct covers, etc.) will be installed together with the electrical services.
- 3.2.20 Towards the end of the main access road construction phase, the new connections with Stather Road south of the Flixborough Industrial Estate and the B1216, will commence. This will require traffic management measures at both locations whilst the new junctions are being constructed. The construction will follow the same format as outlined above and will be graded into the existing road construction. Once completed, the new access will become live, and Stather Road will be closed to public traffic north of the existing pumping station (subject to completion of the Highway Stopping Up Order application).
- 3.2.21 As the new access road construction progresses north, the main access to the ERF will commence following the same form of construction as outlined above. However, the wearing course will not be laid until the main works have been completed. The internal access road will be constructed up to the location of the access ramp to the tipping hall.

Rail Reinstatement/New Railhead

- 3.2.22 Based on the recommendations of the railway condition assessment report, it is anticipated that the whole length of the existing rail track will be removed and replaced together with the removal and replacement of the top one metre of ballast. This will entail the removal of the existing rails, which will be removed from the site for recycling and the top one metre of ballast material which will be placed to one side, stockpiled, and used in the reconstruction of the rail sidings.

- 3.2.23 A loading gauge assessment has been undertaken that has assessed clearances through the bridged sections, determining the works required to each of the bridges. Starting from Dragonby sidings, the progressive reconstruction of the rail line will progress towards Flixborough Wharf. This will allow the timely delivery of new ballast and rails as the works progress down towards the existing wharf. Locally sourced rail lines will be used where possible.
- 3.2.24 A new section of rail sidings will be constructed to the south of the existing wharf. A new railhead will be constructed, which will involve the removal of the existing surface and excavation to the defined formation level. There will be the need to construct retaining walls where there is a difference in the level of the ERF and the rail line. Construction will likely move progressively south using the new rail construction as the means for providing the materials necessary for the construction. Following the installation of the new rail line, the associated services to the rail line will be installed, and then the full line will be commissioned.

Visitor Centre

- 3.2.25 It is proposed that the new visitor centre will be located to the south of the main access road to the ERF, integrating with the proposed wetland/ecological area. The visitor centre will have its accommodation spread over three no. floor levels. The ground floor level will be set to match that of the raised main access road. This ground floor level will incorporate accessible car parking spaces, coach drop off bay, and covered cycle racks, and from here access to the building's lift and stair core will be provided.
- 3.2.26 An external terrace and service accommodation will be provided on the first floor, and the top floor will contain the majority of the visitor accommodation and from where access to the elevated walkway will be provided. The ground floor level will be connected via stairs and ramps to the existing lower ground level from where access routes to the main car park and the proposed wetland/ecological area will be provided.
- 3.2.27 The extents of the footprint of the building and car parking area will have the topsoil removed. The site will be excavated to formation level and imported material will be placed so that the ground slab sits below the flood level as identified in the flood risk assessment. The superstructure will be either steel or timber frame construction with infilled panels and glazing together with internal partition walls. Where possible, recycled materials will be used and a low energy design strategy adopted.

Energy Recovery Facility

- 3.2.28 Following the demolition of some of the existing buildings at Flixborough Wharf, Bellwin House, Wharfeside Court and the area south of the Stather Road, the existing tarmac and concrete hard standing area will be broken up and assessed as to whether it could be used in the construction of the Project. If this is the case, it will be stockpiled; if not, it will be removed from the site. The footprint of the ERF will be raised approximately 2.6m above the existing ground level (6.6m AOD). This will require the construction of a combination of reinforced concrete retaining walls and embankments to facilitate the increased floor level.
- 3.2.29 The location of the fuel bunker will be established, and a sheet pile cofferdam constructed. The sheet pile construction will act as permanent formwork, and the area within the piled structure will be excavated to a depth of approximately 10 metres. The bunker will be designed as a water-retaining structure and constructed to avoid any floatation of the structure.
- 3.2.30 Due to the depths of the bunker, it is envisaged that groundwater will need to be managed. This will be achieved by creating a sump point where the water can be pumped out of the bunker construction and discharged into the local surface water system or suitable lagoon or to feed the wetland area.
- 3.2.31 Imported sub-base material will be brought to the site by road, rail or boat via the wharf. This will be placed, starting from the north of the ERF and working southwards towards Stather road. The imported material will be compacted in layers and terraced until it achieves the level as determined by the flood risk assessment. The installation of precast concrete driven piles will start at the north of the raised platform and move south towards Stather Road. It will be during this stage that the piles for the tower cranes will be incorporated into the piling strategy. The pile heads will be broken out and incorporated into the pile cap. The foundation slabs for the turbine and the boilers, together with all other high load components, will commence. This will be followed by the foundations for the rest of the power island together with the carbon capture, utilisation and storage facility.
- 3.2.32 It is envisaged that three tower cranes will be required due to the reach and access required for the construction. The steel erection of the mainframe will commence with the boiler hall, followed by the turbine hall. As the steelwork for the boiler hall and turbine hall is progressing, the raised slab for the tipping hall will be constructed and connected with the bunker.

- 3.2.33 The boilers will be constructed from east to west, starting with boiler number one. The boiler is made up of a series of prefabricated sections that will be connected on-site together with localised site installation pipework and intermediate steelwork. The ductwork from the boilers will be installed towards the three flues, and these three flues will be erected up to the roof level of the boiler hall. The air-cooled condensers will be installed above the turbine hall. Once the steelwork on the boiler hall and the turbine hall is complete, both structures will be made watertight by the installation of the steel cladding around the frame. During this period, the ERF circulation road will be constructed to enable the delivery of the turbine, generator, and transformers.
- 3.2.34 Once the turbine hall is watertight, the turbine will be delivered to the site and skidded into position onto its plinth together with the generator. Process works within the boiler hall and turbine hall will continue whilst the steelwork for the carbon capture, utilisation and storage facility, the administration building, and the roof of the tipping hall are installed. At the same time, the pillars to the ramp structure will be installed, and the ramp units dropped into place and connected to the tipping hall floor. The three flues will be installed to the roof level of the boiler hall, and then the last sections will be placed using a mobile long reach crane capable of reaching the final stack height. The interior fit-out of the power island will be completed in readiness for commissioning of the plant.

Main Sub-station and Above Ground Gas Installation (AGI)

- 3.2.35 The main sub-station and an AGI will be located to the east of Flixborough Industrial Estate, just off Stather Road. The extents of the development area will be made secure with permanent security fencing. The topsoil will be stripped and stockpiled, and the ground will be taken down to formation level, with a retaining structure likely to be required due to changes in levels. A layer of sub-base material will be imported and compacted to act as a piling mat.
- 3.2.36 Precast concrete driven piles will then be installed. The pile heads will be broken out and incorporated into the pile cap. The ground slab will then be laid together with any service ducts and pipework. The switchyard building will be constructed together with the concrete plinths for the AGI. When the switchyard building is complete, the transformer and switchgear will be skidded into position, and the facility will be commissioned. Following the commissioning of the switchyard, the AGI will be completed and commissioned.

Residue Handling and Treatment Facility

- 3.2.37 Whilst the ERF piling is carried out, the site for the residue handling and treatment facility (RHTF) will be stripped of topsoil and stockpiled. The site will then be made up with imported sub-base material to the level outlined in the flood risk assessment. The piling rigs will then move from the ERF site to the ash processing plant. Piling will commence from the north of the RHTF and work towards the south, finishing on the border of the CBMF. The pile heads will be broken out and incorporated into the pile caps, and then the ground slab will be cast ready for the installation of the superstructure.
- 3.2.38 The RHTF will be of a steel frame construction with steel cladding to the walls and roof in accordance with the architectural strategy. A mobile crane will be brought on-site to erect the steel structure together with the installation of internal mezzanine floors.
- 3.2.39 Once the superstructure is watertight, the internal fit-out will commence in preparation for the delivery of the internal equipment required for processing the ash. Whilst the internal fit-out takes place, the external hard standing fencing and landscaping will take place. The facility will be commissioned and prepared for operation.

Concrete Block Manufacturing Facility

- 3.2.40 The phasing of the concrete block manufacturing facility (CBMF) construction has yet to be finalised. The CBMF will be located on the site of the main contractors' compound for the ERF; therefore, the compound will be reduced to accommodate the CBMF. The sequence of construction will be as follows.
- 3.2.41 The extents of the site will be stripped of topsoil and stockpiled where this has not already been undertaken to prepare the construction compound. Imported sub-base material will be brought on-site and compacted in layers in accordance with the level outlined in the flood risk assessment.
- 3.2.42 Piling using precast concrete driven piles will commence from the north of this site and work towards the south. The pile heads will be broken out, and the ground slab will be cast whilst being tied into the pile caps.
- 3.2.43 A crane will be brought to the site for the erection of the steel frame and cladding. Once the building is watertight, then the internal fit-out will commence together with the delivery of the manufacturing equipment necessary for creating the blocks. Whilst the internal fit-out takes place, the external hard standing fencing and landscaping will take place. The facility will be commissioned and prepared for operation.

Plastic Recycling Facility

- 3.2.44 The extents of the site will be stripped of topsoil and imported sub-base material will be brought on to the site and compacted in layers in accordance with the level outlined in the flood risk assessment.
- 3.2.45 Piling using precast concrete piles will commence from the north of the site and work towards the south. The pile heads will be broken out, and the ground slab will be cast whilst being tied into the pile caps.
- 3.2.46 A mobile crane will be brought to the site for the erection of the steel frame and cladding to the building as outlined in the architectural scheme. Once the building is watertight, then the internal fit-out will commence together with the delivery of the manufacturing equipment necessary for the plastic recycling. Whilst the internal fit-out takes place, the external hard standing fencing and landscaping will take place. The facility will be commissioned and prepared for operation.

Electric Vehicle and Hydrogen Refuelling Station

- 3.2.47 The electric vehicle and hydrogen refuelling station is located on the east side of the new access road with the junction on the B1216. The contractor's compound established for the construction of the new access road will remain in place and fenced off for security purposes. Works will commence by extending the security fence to the extents of the Application Land, and the extent of the site will have the topsoil removed and stockpiled. Imported sub-base material will be placed in layers up to the level identified within the flood risk assessment.
- 3.2.48 A piling rig will be brought to the site and commence from the north side of the development, working towards the south. The pile heads will be broken out and the ground slab cast and tied into the pile caps. A mobile crane will be brought to the site and commence the erection of the steel frame structure for the accommodation part of the refuelling facility. Once the building is watertight, then the internal fit-out will commence. Whilst the internal fit-out takes place, the external hard standing fencing and landscaping will take place. The facility will be commissioned and prepared for operation.

District Heating and Private Wire Network (DHPWN)

- 3.2.49 The district heating supply and the return pipelines, the high voltage (HV) cables, gas pipes and communication fibre, will run along Stather Road and then follow the route of the new access road until it meets the junction of the B1216 and A1077.

- 3.2.50 At this location there will be a below-ground pressure balancing plant as the pipeline takes routes to the northeast (northern district heating and private wire network NDHPWN) and south (southern district heating and private wire network SDHPWN).
- 3.2.51 The services that are integrated within the new access road and head south will be direct buried. This involves excavating a trench to the designed depth and width to accommodate the pre-insulated pipes and cables. Where direct burial is not possible trenchless techniques such as horizontal directional drilling or thrust boring may be used.
- 3.2.52 The north-eastern route of the pipeline as it enters Scunthorpe will be directly buried as outlined above until it reaches the more heavily built-up areas. At this point the construction will be a mixture of direct burial and directional drilling techniques. When the pipeline reaches the junction of the A1011 and B1430 the construction will be direct buried but under the existing road as there is very little space in the footpaths which will already have a significant number of services present. There will be the requirement for small compounds along the pipeline route for the welfare and storage facilities required by the contractors.
- 3.2.53 A number of surface features (including areas of environmental importance, major junctions and heavily wooded areas) will have to be navigated by the routing of the district heating network as it enters Scunthorpe. These surface features will require directional drilling techniques, where ducts are bored from the surface at one side of the obstruction and surface at the other side. The pre-insulated pipes and cables are then threaded through these ducts.
- 3.2.54 The method of construction for the sections of the pipeline within the road will be similar to those mentioned above. Agreed traffic management measures will be put in place so that sections of the road can be excavated. The pre-insulated pipes and cables will be installed and backfilled in accordance with the local authority's highway specifications. The intention will be to place any pressure balancing/valve chambers within the confines of the receiving buildings in order to avoid below ground structures in the road
- 3.2.55 All traffic management measures will be subject to the appropriate approvals process prior to the commencement of the works (see Section 4.5). The overall extent of the proposed pipe network along with proposed methods of construction, working practices and potential mitigation measures have been discussed with NLC and adjustments have been made to the proposed design as a result of the feedback received.

4 Vehicle Routes and Access

4.1 Routing of HGV Construction Traffic

4.1.1 This section describes the vehicle route and access arrangements for demolition / construction vehicles travelling to and from the site. The proposed arrangements follow the same routing to be used by HGVs during operation and seek to minimise the impact of construction traffic on the local and wider highway network.

4.1.2 Routes for construction traffic involved in the delivery of goods, materials and plant to and from the site will be agreed with NLC prior to the commencement of works. The proposed traffic routes to and from the site (as illustrated in Figure 4.1 and Appendix D) use the strategic road network (NLSRN) as much as possible, in line with North Lincolnshire Local Plan.

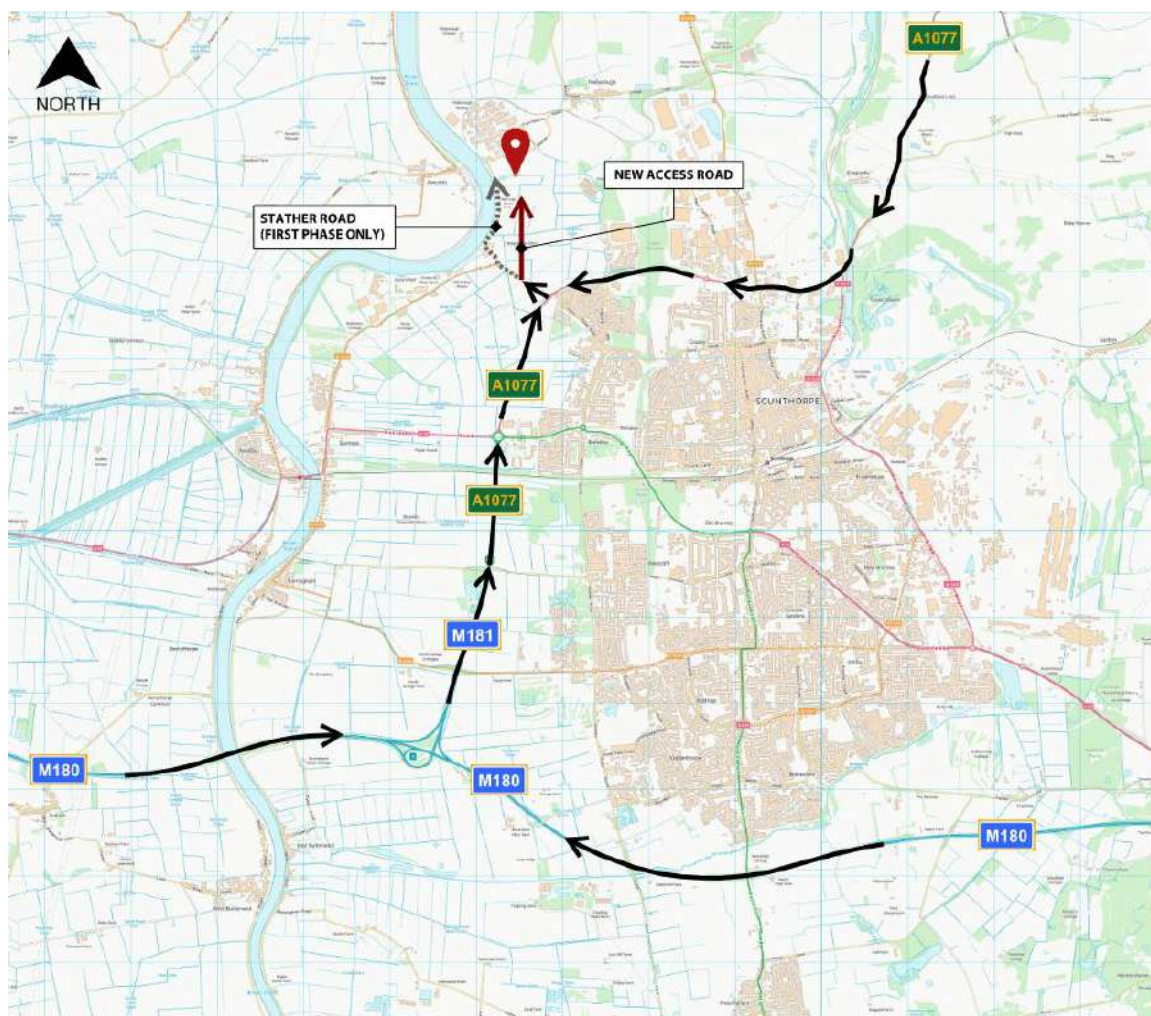

Figure 4.1 Principal Construction HGV Access Routes (refer to Appendix D for larger version)

- 4.1.3 The majority of construction traffic (in terms of deliveries and other HGVs) are expected to arrive to/from the south, via the M180 and would approach the site via the M181 and A1077. A smaller proportion is predicted to arrive from the north-east via the A1077, from Hull and its environs.
- 4.1.4 Once construction traffic reaches the A1077, it approaches the site (from north or south) by turning on to the B1216 Ferry Road West via the A1077 / B1216 signal-controlled junction.
- 4.1.5 Initially, construction traffic will then divide according to area of work within the site. Works within or adjacent to Flixborough Industrial Estate, such as site establishment and demolition, will be approached via the B1216 and Neap House Road roundabout and the existing Stather Road route adjacent to the River Trent.
- 4.1.6 As noted in Section 2.3, Stather Road is currently restricted to single file operation due to the road being narrow / unsuitable for two-way HGV movements. It is therefore not considered ideal for major HGV access during the construction phase. Construction traffic will only be directed via this route during the early stages of the programme (Year 1) with the New Access Road between the B1216 and Stather Road forming the main access route for the remainder of the construction phase.
- 4.1.7 Construction traffic associated with the New Access Road will access the works directly from the B1216. The location of the works access will be coordinated with the construction of the new access junction on the B1216 (which is proposed as a new roundabout).
- 4.1.8 Depending on the detailed phasing of the proposed roundabout construction, and to minimise right-turning movements on the B1216 until the new roundabout is completed, the works access might be directed to the Neap House Roundabout to U-turn, and make a left turn into the site
- 4.1.9 Once the New Access Road is open together with the new roundabout junction with the B1216, all subsequent construction access will be routed via this New Access Road and the section of Stather Road to the north of the existing pumping station will be closed to public traffic (subject to completion of the Highway Stopping Up Order application).
- 4.1.10 As indicated on Figure 4.2, vehicles along Stather Road via Flixborough village and/or the B1216 Neap House Road would be limited to cars and small vans only due to the existing 7.5t weight restrictions on these routes. Construction workforce will be discouraged from using the route through Flixborough village (as discussed below in Section 4.2).

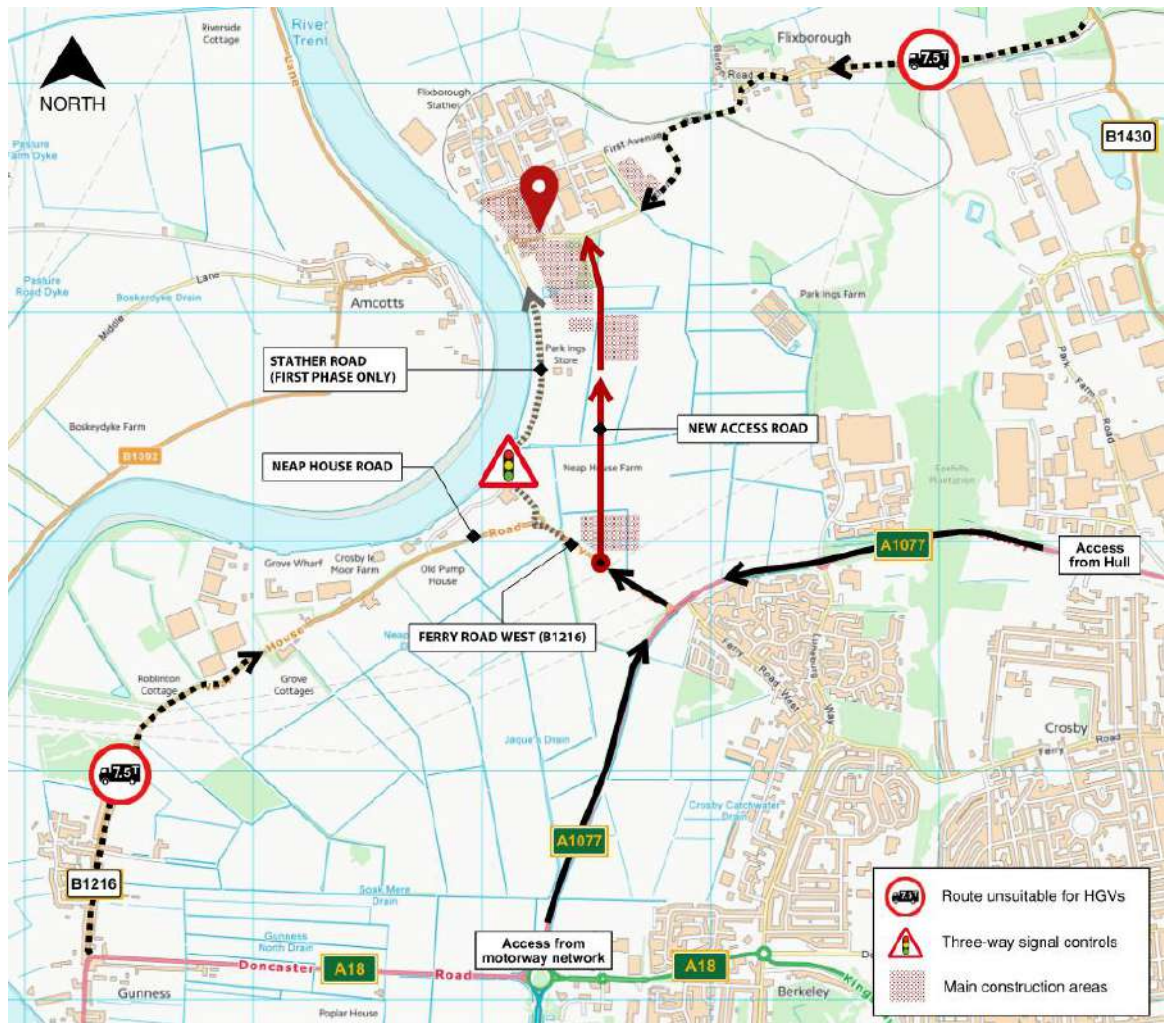

Figure 4.2 Local Construction HGV Access Routes (refer to Appendix D for larger version)

4.1.11 The specific approach to managing access to each area on site – whether they are hoarded, gated and controlled individually or from a single point - is a level of detail that has not been developed at this stage. There will be a number of contractor’s compounds established as the construction phases progress and hoarding lines, haul routes, storage areas, laydown areas etc will evolve in line with this phasing and will be developed once contractors have been appointed. This will also need to be coordinated with ongoing access requirements to neighbouring properties and short-term traffic management measures associated with utilities diversions/installations.

4.2 Routing of Construction Workforce Travel

- 4.2.1 It is anticipated that a proportion of the construction workforce would travel to the site by motor vehicle given the site location and need to transport tools etc. These vehicles could comprise cars and company vans and would follow the routes indicated on Figure 4.2.
- 4.2.2 Whilst vehicles used by the workforce would be permitted to use Stather Road via Flixborough village, it is recommended that this route is discouraged as their means of access to/from the site in order to avoid imposing significant additional traffic through the village and potentially giving rise to significant adverse impacts on local residents.

4.3 On-Site Traffic Management

- 4.3.1 It is anticipated that a logistics company will be employed to manage construction traffic on and off the site. The detailed layout of the site during works, including layout of the main temporary contractor's compound, welfare facilities, contractor parking etc have not been determined at this stage, though provisional spatial allocations have been made (refer to phasing plans in Appendix C).

Site Access

- 4.3.2 All vehicles accessing the site will be received by traffic marshals. Vehicles will be checked against the daily manifest and directed to the relevant work site / loading bay. The screening area will be sized to accommodate vehicles within the site, to avoid waiting vehicles queuing on the highway.
- 4.3.3 The layout of the site will enable all vehicles to enter and exit in forwards gear – reversing of vehicles onto the highway will not be permitted.
- 4.3.4 Vehicles and loads not accepted would be rejected from the compound or works area. They would be directed to turn within the site and leave in a forward gear. They would not be inspected within the Public Highway.
- 4.3.5 Facilities such as wheel-washing/vehicle wash-down will be provided, as outlined in Section 5.2.

Vehicle Holding Zone

- 4.3.6 Delivery vehicles will be directed to the relevant area for loading / unloading; if the loading bay is not available, they would be directed to a Vehicle Holding Zone (VHZ), or if they are not correctly booked, they would be banked away from site and asked to rebook.

- 4.3.7 The VHZs will be provided to ensure that vehicles are accommodated within the curtilage of the site, to avoid any overspill onto the adjacent highways. I
- 4.3.8 An off-site construction vehicle holding area has not been identified at this stage but will be considered, if necessary, in addition to the on-site facilities.

Loading Bay Marshals

- 4.3.9 Traffic marshals will be stationed at each building unloading zone in order to safely facilitate the manoeuvring of vehicles within the unloading zone. Traffic marshals will be presented at the daily briefing with a tablet (or equivalent) device, on which will be the delivery schedule for the day; this schedule will also be issued to site security. Deliveries will be released from the VHZ by the delivery coordinator once confirmation is given by the relevant unloading marshal that they are ready to proceed. All traffic marshals must have the relevant competency for banking vehicles.

Loading Bay Slingers

- 4.3.10 Each loading bay will have a designated Crane Signaller ('Slinger') who will monitor and manage the safe unloading of materials. The Slinger will also assist with the banking of crawler cranes around the building perimeter and monitor safe exclusion zones for crane working areas. Subcontractors will be responsible for the checking of materials and unloading at the floor plate level.

On-Site Parking

- 4.3.11 Construction operatives, site employees and visitors who drive to the site either by private or company vehicle will park within a designated parking area; traffic marshals will direct authorised construction employees to a designated parking area as required. The location of contractor parking will be adjusted to suit each phase of works as necessary (refer to phasing plans in Appendix C). Construction employees will be encouraged to make use of sustainable travel options where possible.

Plant and Materials Storage

- 4.3.12 All required plant and materials will be accommodated within the confines of the site. In order to minimise damage to construction materials and also loss and waste, secure facilities will be provided. The use of fencing/hoarding will restrict unauthorised access. A manned checkpoint will be in place to monitor delivery and construction vehicles.

4.4 Public Rights of Way Considerations

4.4.1 The final alignment of the northern and southern district heating and private wire networks (DHPWN) may affect Public Rights of Way (PRoW) on a temporary basis. The general reasonable worst-case disruption would be for sections where the typical 200m working length (of open excavation for ducting installation) disrupts a given PRoW for the approximate seven working days that it is present at that location and for the construction of jointing pits. Extended disruption may occur at locations where trenchless installation (e.g. drilling or boring activities) are required and the drilling compound coincides with the PRoW. Similarly, railway reinstatement works are expected to have temporary impacts on PRoW routes.

4.4.2 The following principles have been established:

- no permanent diversion or closure of a PRoW is proposed as part the proposals
- no temporary closure of any PRoW in its entirety is proposed; where localised temporary closures are required, it is expected that a temporary diversion will be sought and will be achievable
- where PRoWs are affected or diverted, the width any temporary alternatives or diversions will be no less than the existing access provision available where practicable. Where this is not possible, the following minimum widths should apply: Public Footpaths: 2m, Public Bridleways 3m, Restricted Byways 3m
- an appropriate path surface should be provided along the alternative or diversion route. The specification of the path surface would be included in the Detailed CLP and agreed with the NLC; and
- the contractors installing the DHPWN and carrying out the railway reinstatement will proceed on the basis of seeking to provide 'no less preferable access', e.g. that they do not introduce steps where drop kerbs or ramps were present previously and that widths do not reduce where the PRoW is currently wider than the target minima set out above.

4.4.3 The 'rights of way and access plans' have identified three locations where temporary diversions are expected to be required (refer to Appendix E); two locations are associated with railway reinstatement works and one at a crossing of the A1077 Phoenix Parkway, associated with installation of the DHPWN at this location. The diversion details will be subject to further development once the Principal Contractor and relevant sub-contractors have been appointed and developed proposals will be included in the Detailed CLP.

4.5 Temporary Traffic Management and Traffic Regulation Orders

- 4.5.1 The temporary closures of footways, footpaths, cycle paths and traffic lanes along with road closures, suspensions of access restrictions and on street parking would be determined prior to the Detailed CLP being prepared. Any permits and licences, deemed necessary, would be identified in the Detailed CLP and progressed in accordance with the processes set out in the granted DCO and the finalised Code of Construction Practice (CoCP).
- 4.5.2 The need for licences for the use of two way and multiphase temporary signals would be determined through the detailed programming of the highways, DHPWN and utilities works. Temporary traffic controls would be managed so as to minimise delays to local bus services. This could include manual intervention during busy traffic periods to balance waiting times.
- 4.5.3 Statutory undertaker connections to the temporary contractors' compounds would be undertaken by approved statutory undertaker contractors. This would include electrical, communications, water and sewer connections to the construction sites and compounds. Those contractors' works would be co-ordinated in accordance with standard New Roads and Street Works Act 1991 systems.

4.6 Network Rail Asset Protection

- 4.6.1 Construction and subsequent maintenance must be carried out without adversely affecting the safety of, or encroaching upon Network Rail's adjacent land. In addition, security of the railway boundary will require to be maintained at all times. Discussions have already been initiated with the Asset Protection and Optimisation teams (ASPRO) as suggested with regards to the M181 corridor works.

5 Strategies to Reduce Impacts

5.1 Introduction

5.1.1 A range of measures are proposed to reduce the potential impacts of demolition, infill and construction traffic on the local highway network and community. The measures can be categorised as follows:

- Committed – measures that will be implemented as part of the CLP
- Proposed – measures that are feasible and likely to be implemented. Once a contractor is appointed these measures will be studied further and confirmed within the Detailed CLP; and
- Considered – measures that are unlikely to be implemented or feasible but could be investigated or become relevant in the future.

5.1.2 In accordance with CLOCS CLP guidance, the following measures have been identified as committed, proposed or considered as indicated:

Table 5.1 Planned Measures to Reduce Construction Impact

Planned Measures	Committed	Proposed	Considered
Measures influencing construction vehicles and deliveries			
Safety and environmental standards and programmes	✓		
Adherence to designated routes	✓		
Delivery scheduling	✓		
Re-timing for out of peak deliveries		✓	
Re-timing for out of hours deliveries		✓	
Use of holding areas and vehicle call off areas		✓	
Use of logistics and consolidation centres			✓
Measures to encourage sustainable freight			
Freight by water			✓
Freight by rail			✓
Material procurement measures			
Design for manufacture and assembly and off-site manufacture			✓
Re-use of material on site		✓	
Smart procurement		✓	
Other measures			
Collaboration with other sites in the area			✓
Implement construction workforce travel plan	✓		

5.2 General Measures

Site Working Hours

5.2.1 Subject to confirmation through the DCO and the Detailed CLP, days and time during which construction activity will normally take place on the Project Site are as follows:

- 07:00 – 19.00 hours Monday – Friday (noting that workforce traffic will arrive at the site during the hours of 06:00 to 07:00)
- 07:00 – 13:00 hours Saturday with work taking place after 13:00 up to 23:00 hours subject to agreement with NLC on the nature of works and associated noise controls to be set out in the CEMP
- No working on Sundays, Bank or Public Holidays unless with specific agreement of NLC
- No working during night-time hours of 23:00 to 07:00 except with specific agreement of NLC and/or in the event of an emergency.

5.2.2 Any work outside of these hours will be subject to prior agreement with NLC and relevant stakeholders with a sufficient notice period given to consider the application. Certain specific construction activities (including highway works) may require extended working hours for reasons of engineering practicability and safety such as slip form working, surveys and lifting/fitting of infrastructure and abnormal deliveries.

5.2.3 Whilst night-time (23:00-07:00), out-of-hours or Sunday working would not normally be permitted, it is conceivable that certain works may have to be undertaken during these periods. If necessary, the hours of operation for such works would be subject to prior agreement and reasonable notice with NLC.

5.2.4 Where practical the Principal Contractor would consider programming site deliveries to arrive after 09:00 Monday to Friday, to seek to minimise impacts on the local highway network peak periods.

Local Residents and Businesses – Community Considerations

5.2.5 The CLOCS CLP guidance adopts the umbrella term ‘Community Considerations’ to address the main concerns caused by construction logistics activities, particularly at the local level. Such activity can have a significant impact on the surrounding community especially when residential areas and/or facilities like schools, hospitals, health centres, community centres, sports facilities, transport hubs, etc are located near the work site.

- 5.2.6 There are residential areas and associated amenities to the north-east (Flixborough) and south (Neap House) that might be somewhat affected by the construction activities. It is likely that works could have some impact on residents and local businesses, including construction noise, workforce use of local public transport, temporary traffic management etc.
- 5.2.7 Therefore, the Community Engagement Officer for the Project will regularly contact local businesses/surrounding communities to share information in order to advise on potential disruption and provide a point of contact for queries.
- 5.2.8 The Applicant is to liaise with local interest groups and the local authority throughout the process and provide updates on key dates.

Waste Management

- 5.2.9 The disposal of waste generated during construction, including any surplus spoil, will be managed to maximise the environmental and development benefits from the use of surplus material and to reduce any adverse effects of disposal. In general, the principles of the waste management hierarchy, which favours waste minimisation, re-use of materials and recycling over disposal to landfill will be favoured.
- 5.2.10 Methods for waste reduction will form a basic strategy for construction waste management from the start. These materials will generally be inert or environmentally benign and may have alternative uses elsewhere on the site. Opportunities will be investigated to maximise the recycling potential of construction materials.
- 5.2.11 Some contaminated materials may be found during the development. Any contaminated materials that may be generated shall be stored and disposed of in accordance with relevant best practise guidance and legislation.
- 5.2.12 Licensed carriers will remove other residual waste, i.e. general office waste, etc. from site to suitable licensed disposal sites. Where possible, segregation and recycling of materials, such as office paper, food waste will be undertaken.

Noise, Dust and Dirt

- 5.2.13 All equipment, pollution control measures and methods of work will be in place in line with current standards. Engines are not to be left running when the vehicle is not in operation.
- 5.2.14 The following measures are to be considered:

- mud and debris - the site will be equipped with appropriate wheel cleaning equipment, along with the provision of a road sweeper as required to prevent the build-up of mud on the site roads and the adjacent highway
- dust - a mobile water bowser will be available on-site and will be used to suppress dust arisings from any operations during the Works, but particularly during periods of dry weather. All vehicles delivering soils or hard-core to the site for use in the works or removing excess hard-core on completion of the works will be fully sheeted to prevent spillage and windblown dust
- noise - 55dB is considered by the World Health Organisation to be the daytime noise level above which 'community annoyance' sets in. No filling or construction operations will be undertaken outside of the permitted hours
- surface water - during construction works the Contractor will install and maintain surface water control features (e.g. temporary earth mounds, ditches, swales and settlement ponds etc.) in accordance with industry best practice and guidance, in order to prevent the accumulation or the uncontrolled runoff of surface water; and
- pollution prevention - no oils or potentially harmful chemicals will be stored outside the contractor's compound. Maintenance and repairs of plant and machinery will be in accordance with manufacturers recommendations and will be undertaken by mobile 'fitters' in a site compound area. Plant and machinery will be stored in this area during non-operational periods. Fuel will be stored in and delivered from a self-bunded, double skinned mobile fuel bowser.

5.2.15 All contractors will be expected to comply with the policy and British Standards requirements in relation to construction noise.

5.3 Safety and Environmental Standards and Programmes

CLOCS – Construction Logistics and Community Safety

5.3.1 The CLOCS Standard (The Standard for construction logistics: Managing work related road risk) draws together emerging practice from a number of individual standards, policies and codes of practice to form a single road risk standard. This standard will be implemented by the Principal Contractor (as well as suppliers and sub-contractors) and will be adhered to in a consistent way by fleet operators.

FORS - Fleet Operator Recognition Scheme

5.3.2 FORS is a voluntary national fleet accreditation scheme designed to help improve fleet operator performance in key areas such as environmental performance, safety and operational efficiency. Its purpose is to raise the level of quality within fleet operations and to recognise those operators that are achieving the environmental, safety and efficiency requirements of the FORS standard.

5.3.3 All construction vehicle operators will be required to be accredited in line with FORS, unless a specific exception is agreed with NLC prior to that haulier or supplier visiting site.

Considerate Constructors Scheme

5.3.4 The project will be registered with the Considerate Constructor's Scheme. The most up to date CCS 'Code of Considerate Practice' will be explained to operatives and employees during the site induction and reinforced with periodic toolbox talks.

5.4 Adherence to Designated Routes

5.4.1 Construction vehicles will be required to adhere to the designated construction routes identified. A clear signage strategy will be implemented to ensure construction traffic follows designated routes; the format of that strategy would be set out in the Detailed CLP.

5.4.2 The designated routes will form an integral part of the supplier sub-contracts. Delivery drivers will be issued with agreed routes during induction which they will be required to sign off; penalties may be considered. To enforce adherence, the site management team will undertake spot-checks on a monthly basis.

5.4.3 Routes for ALLs would be determined by the haulier in collaboration with the affected Police and local highways authorities. These would be determined by the configuration of the load, depending on its height, width, weight and length. The need for escort vehicles would be determined through that process.

5.5 Delivery Scheduling and Retiming

5.5.1 The following measures will be implemented:

- a controlled entry system to manage access to the site at all times
- implementation of a Delivery Management System (DMS)
- deliveries will require pre-booked slots to allow for off-loading in a systematic and controlled manner; and
- no unauthorised delivery vehicles will be accepted.

5.5.2 The DMS will ensure deliveries are effectively managed to maintain a steady flow of traffic in accordance with long range, weekly and daily plans. This managed logistic approach aims to streamline deliveries using pre-booked slots, allowing unloading of deliveries in a systemic/co-ordinated approach at their designated location.

- 5.5.3 Retiming of deliveries outside peak traffic times may improve the operational efficiency of the construction site, as well as lessening the impact of vehicle activity on the neighbouring area.
- 5.5.4 In the case of deliveries (and collections) by water, these are anticipated to occur at varying times over a 24-hour period, as they would be governed by the tidal state of the River Trent.
- 5.5.5 As with many long-haul deliveries, due to tachograph restrictions, an area within the site or within the contractor's welfare area will need to be made available for drivers to rest.
- 5.5.6 It will be important that the content of the delivery schedule is cascaded down to traffic marshals tasked with implementation. Daily on-site meetings will be held to ensure that the traffic management team is briefed on the work tasks to be performed each day.
- 5.5.7 Sub-contractors will be reminded about their obligations to ensure that the number of deliveries to the site are minimised. Waste such as packaging, crates and pallets must be returned with the delivery or later deliveries.

5.6 Use of Holding Areas and Consolidation Centres

- 5.6.1 The use of a holding area for construction vehicles approaching the site has been considered but the location of the development and amount of available space at the Project does not lead to this type of facility being required for the construction works.
- 5.6.2 The decision to use a consolidation centre would be made once the Principal Contractor has been appointed and its need and viability investigated in greater detail. The conclusions and result of the appraisal, and the approach to be adopted would be set out in the Detailed CLP.

5.7 Measures to Encourage Sustainable Freight

- 5.7.1 Once completed and operational, the Project is intended to make use of both rail and river for freight transport, and the works include a new railhead and reinstatement of the railway line to Dragonby Sidings to facilitate this.
- 5.7.2 The potential use of the railway and/or river to support construction logistics is still under consideration at this stage.

- 5.7.3 Whilst the Project is conveniently located adjacent to the Flixborough Port on the River Trent, the tidal range is significant, which limits the operational window for construction access.
- 5.7.4 Although the use of river transport could replace a significant number of HGV movements on the highway network, the practicalities of material handling at Flixborough Port and transferring to the site have yet to be evaluated.
- 5.7.5 At this stage, it is anticipated that abnormal and indivisible loads will not be transported to site by ship. Until the design is more developed, the size and weight of such loads cannot be fully established and thus whether they can be transferred by the crane at the wharf. This will be reviewed as the design is developed with a view to maximising the number of abnormal loads that can be transported by river instead of by road.
- 5.7.6 To ensure the most conservative assessment of activity, this document (and the Transport Assessment) assumes that all 'bulk' construction materials and workforce transport will take place by road, but the use of the river and rail facilities will continue to be investigated as the contractor team is established, with a view to maximising the benefits of these alternative freight transport modes.

5.8 Material Procurement Measures

Consolidation and/or Collaboration and off-site Fabrication

- 5.8.1 An online system will be used to provide accurate design information and drawings for the project team. This will enable development teams to specify materials needed which will reduce over-ordering, off-cut waste and reworking through the supply chain. In addition, the design will seek to incorporate various pre-manufactured items, reducing the number of deliveries and waste collections from the site.
- 5.8.2 The potential to use prefabricated assemblies and techniques would be considered as an approach to reduce the number of construction vehicle movements, once a Principal Contractor has been appointed. A decision as to how prefabrication might be integrated into the construction process would be included in the Detailed CLP.

Reuse of Material on Site

- 5.8.3 Demolition materials arising from site clearance and ground preparations could potentially be reused as part of the site levelling and the provision of a building platform and piling mat for the construction works. The material would be stored within the site area until required.

5.8.4 This would be determined during the detailed design development and reflected in the Detailed CLP. Consideration would also be given to the reuse of excavated material for filling, depending on its suitability - e.g. potential contamination. Where possible, the project could seek to maximise the reuse of suitable soils for landscaping, to minimise waste disposal.

Smart Procurement/Local Suppliers

5.8.5 In line with the procurement strategy, local suppliers for construction materials will be sought as far as practicable, in order to reduce the impact of the development on the surrounding highway network, as well as promoting a more sustainable development. Reductions in delivery costs, fuel usage and pollution along with congestion may be achieved. The promotion of local suppliers also benefits the local community with investments into local employers and services.

5.9 Collaboration with Other Sites in the Area

5.9.1 The Applicant would consider working with other construction site contractors in the vicinity and would ascertain the feasibility of a shared consolidation or holding area for construction vehicles and/or materials. If a suitable forum were to be established, the Principal Contractor could attend working group meetings to discuss opportunities to collaborate with other sites and suppliers, to minimise any disruption during the construction stages.

5.10 Implement a Workforce Travel Plan

5.10.1 Whilst it is not compulsory to complete a Travel Plan for the construction period, it is proposed that pertinent information will be disseminated to the workforce employed on or visiting the site, given the projections for a significant construction workforce. Such information would comprise:

- site induction with detail of sustainable travel options; and
- site-specific travel information.

5.10.2 A Workplace Travel Plan has been provided for operational workers at the Project; the Detailed CLP should include details of travel planning initiatives and measures to encourage more sustainable modes of travel for construction employees engaged on the project.

5.10.3 The need for workers to drive to the site is recognised and on-site parking for cars and vans is proposed to address this.

5.10.4 The Principal Contractor will maintain the role of a Travel Plan Coordinator (TPC) who will champion initiatives to reduce the environmental impacts of work force travel and to minimise the impacts of commuting on the local road network.

5.10.5 The TPC would:

- implement and actively promote Travel Plan measures to maximise the use of non-car modes of travel to and from work, such as providing information on public transport services in the area
- ensure the requirements for workforce inductions, briefings and communications include information and guidance on the importance of environmentally friendly commuting
- act as a focal point for workforce commuting issues
- manage the monitoring, assessment and review of workforce travel patterns; and
- engage with subcontractors to encourage their workers to commute sustainably where practical.

5.10.6 The Principal Contractor and sub-contractors would consider the use of crew buses to limit the number of individual car journeys. These could be established to provide a link between the site and Scunthorpe/Althorpe stations or alternative 'park-and-ride' locations.

6 Preliminary Construction Vehicle Movements

6.1 Vehicle Forecasts

- 6.1.1 Construction and workforce activity have been estimated across the build-programme from a number of sources, including data from a comparable ERF development. It is acknowledged that these estimates are preliminary only, as the design of the various facilities remains at concept design stage. As the proposals are refined, these forecasts will be developed and updated and included within the Detailed CLP to be submitted prior to commencement of the works.
- 6.1.2 Vehicular activity has been assessed over two main components – construction materials (including delivery / removal of materials, plant, etc) and workforce travel – each predicted to have very different characteristics.
- 6.1.3 Several main peaks of ‘delivery’ activity are predicted in early 2024, through 2025 and 2026 and in late 2027, as shown in Figure 6.1 (enlarged versions of Figure 6.1 to Figure 6.3 are included in Appendix F). Early 2024 corresponds to the import of a significant volume of fill material associated with the ERF over several months. The subsequent peaks through 2025 and 2026 generally relate to overlapping activities associated with other facilities including the switchyard, residue handling and treatment facility and CBMF. The final main peak forecast for late 2027 relates to the start of works on the plastic recycling facility.

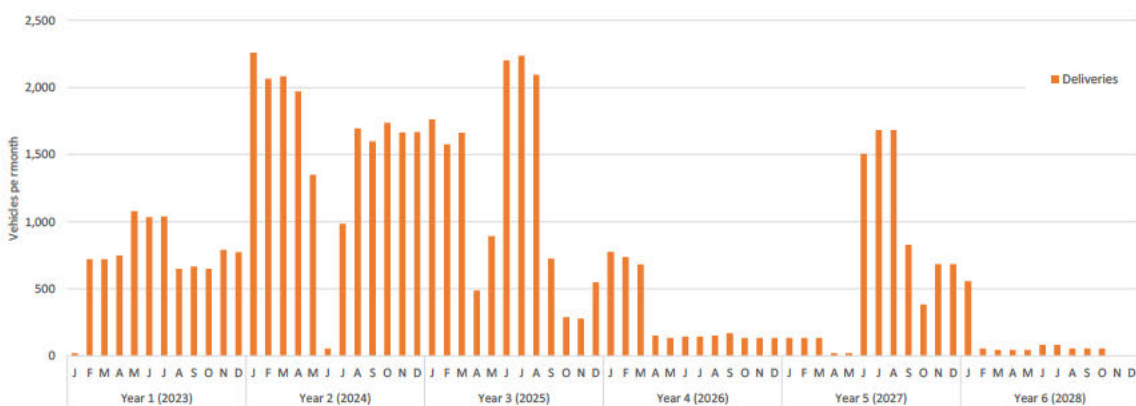

Figure 6.1 Forecast of monthly construction vehicle arrivals

- 6.1.4 By contrast, the construction workforce is forecast to grow gradually in line with progress on the ERF, and then to reduce significantly for the remaining works, as illustrated in Figure 6.2.



Figure 6.2 Forecast of monthly workforce vehicle arrivals

6.1.5 When the deliveries and workforce travel are considered together, the relative magnitude becomes more apparent, as illustrated in Figure 6.3 and it can be clearly seen that the total traffic impacts are largely dictated by workforce travel, which will be mostly by car and/or ‘light’ goods vehicles (LGVs) and will generally be focussed towards the start and end of the working day, whereas construction vehicles (HGV movements) will be spread across the entire working day. The impacts of construction traffic are considered further in the Transport Assessment accompanying the Application.

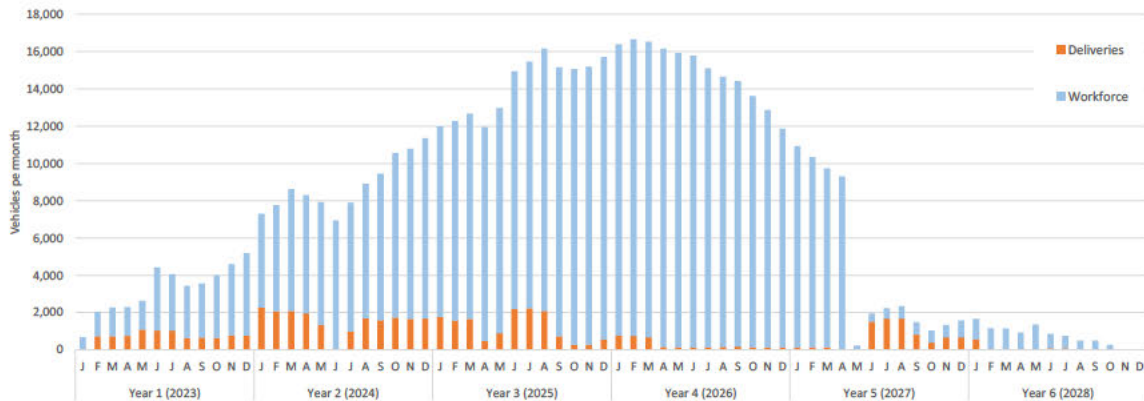

Figure 6.3 Combined monthly forecast for construction deliveries and workforce vehicles

6.1.6 As illustrated in Figure 6.1 and Figure 6.2, the construction traffic and workforce travel forecasts vary significantly across the duration of the programme. A summary of the typical monthly and daily activity across each of the six years of the programme is provided below in Table 6.1. Even within any given year, considerable variation in predicted, particularly in terms of construction deliveries; accordingly, extreme ‘outliers’ in data have been excluded from the summary below for simplicity.

Table 6.1 Peak construction traffic by year

	Vehicles per month		Peak vehicles per day	
	Construction vehicles	Workforce vehicles	Construction vehicles	Workforce vehicles
Year 1 (2023)	650-1,080	660-4,420	30-50	35-220
Year 2 (2024)	985-2,260	5,040-9,700	45-105	250-485
Year 3 (2025)	280-2,240	10,230-15,160	15-105	510-760
Year 4 (2026)	130-775	11,730-16,020	10-40	585-800
Year 5 (2027)	130-1,680	440-10,800	10-80	20-540
Year 6 (2028)	50-560	440-1,100	5-30	20-55

(NB excludes short term outliers or reductions below typical yearly activity)

- 6.1.7 For construction vehicle trips, the peak periods are forecast to generate c.80 and 105 vehicles per day respectively for a few months. This equates to between 8-10 construction vehicle trips (arrivals) per hour, assuming an efficient scheduling system. For these months, consideration should be given to how to most effectively manage the site entrance area and 'paperwork' checks to avoid any risk of queuing vehicles having an effect on adjacent highways, e.g. through the provision of extra waiting/screening provision within the site and extra personnel to manage access.
- 6.1.8 It is noted that for the above projections, all construction deliveries are conservatively assumed to be made by road. The potential use of rail or river modes for freight transport would have the potential to significantly reduce the number of construction vehicle movements by road and this is being investigated further as the scheme develops.
- 6.1.9 For workforce access, the peak forecast is for c.800 inbound car/LGV trips per day. Weekday working hours are expected to be 06:00 to 19:00 and therefore the majority of construction employee travel is expected to fall outside peak hours for the local highway network.
- 6.1.10 The construction of the ERF, which is responsible for a large proportion of workforce travel, requires a wide range of construction trades and labour; and design and management personnel. The Principal Contractor's workforce is expected to work a typical single shift. There will, however, also be a range of specialist contractors' teams employed during the construction programme which will have differing work requirements across different hours. This will spread the arrival and departure profile of commuting across a number of hours, diluting the potential impact on the operation of the transport network.

- 6.1.11 During the peak construction months there will be a greater opportunity to transport employees from local areas by minibus when employee numbers are at their highest; this is recommended but has not currently been assumed in the workforce travel forecasts to ensure a conservative estimate of vehicle numbers.
- 6.1.12 Although the site is within reasonable cycling distance of Scunthorpe, Althorpe and other local villages, the need to carry tools and Personal Protective Equipment, and the physical nature of the work, is likely to deter the vast majority of construction employees from cycling to/from the site. Similarly, walking is unlikely to be a realistic travel option at this location.

6.2 Construction Vehicle Types

- 6.2.1 The construction vehicle types visiting the site will change over the course of the works and type of activity. An indication of the types of vehicles expected at the site is provided below in Table 6.2. LGVs would be present at all stages of the works programme, but in greater numbers during the fit-out stages when tradespeople are on-site.

Table 6.2 Indicative Construction Vehicle Types for each Stage of the Works

Works Programme	Construction Vehicle Types
Demolition	7.5 to 26t rigid lorries, 26t to 32t skip lorry
Enabling (Infill)	Articulated tipper lorry (44t)
Foundations and slab	Articulated lorry, 7.5 to 26t rigid lorries, 26t to 32t skip lorry
Substructure	Articulated lorry, 7.5 to 26t rigid lorries, concrete wagons
Superstructure (core and frame)	Articulated lorry, 7.5 to 26t rigid lorries, concrete wagons
Cladding / Envelope	Articulated lorry, 7.5 to 26t rigid lorries, LGVs
MEP, services and finishes	ALLs (tbc) Articulated lorry, 7.5 to 26t rigid lorries, LGVs
Landscaping	Articulated lorry, 7.5 to 26t rigid lorries, LGVs

- 6.2.2 It is anticipated that a number of Abnormal Indivisible Loads (AILs) are likely to be required during construction. Such loads could include cranes and other large plant, including earth-moving machinery and piling rig, as well as the process machinery associated with the ERF such as the steam turbine, generator and boiler drums. A detailed assessment of the plant requirements and requirements for AILs has not been undertaken at this stage.

- 6.2.3 Any AILs that are required by road during the construction period would be pre-planned and the route and timing of the journey agreed with NLC and the relevant authorities such as National Highways and the Police as appropriate. Any AIL routing would be timed to minimise disruption to other road users, particularly on the strategic road network.
- 6.2.4 If practical, the use of river / rail freight transport for AILs will be considered but, at this stage, there is insufficient detail on the nature of the AILs' to assess this possibility. With the current wharf arrangements at Flixborough Port, preliminary evaluation indicates that it probably won't be possible to deliver AILs via the Port, but this will be reviewed when more detail is available on the precise nature of any required AILs, which cannot be determined until the design is more developed.

7 Implementing, Monitoring and Updating

7.1 Management

7.1.1 It is envisaged that the Principal Contractor (appointed by the Applicant) will produce a Detailed CLP for submission and approval by NLC prior to commencement of works. This Detailed CLP will be prepared based on the general contents of this Outline CLP.

7.1.2 The Detailed CLP will be managed by the Principal Contractor. A nominated employee will be appointed as 'Logistics Manager' and will be responsible for the day-to-day organisation and monitoring of construction logistics for the site, for the duration of the construction phase.

7.2 Monitoring and Review

7.2.1 A key role of the Logistics Manager will be to undertake on-going monitoring. Data to be collected will include:

- Number of vehicle movements to the site:
 - total
 - by vehicle type/size
 - time spent on-site
 - origin and destination of vehicles arriving at or leaving the site; and
 - delivery/collection accuracy compared to schedule.
- Breaches and complaints i.e. with regards to:
 - community concerns about construction activities
 - vehicle routing
 - unacceptable queuing
 - unacceptable parking
 - compliance with safety and environmental standards and programmes; and
 - anti-idling.
- Safety:
 - logistics-related incidents

- record of associated fatalities and serious injuries
- methods by which employees are travelling to the site; and
- vehicles and operators not meeting safety requirements.

7.2.2 For those suppliers and hauliers that continually fail to follow advice to avoid delivering during peak periods or conform to other instructions such as not stopping on-street or fitting vehicles with cyclist protection equipment, the site manager will liaise with these operators to ensure their level of compliance improves.

7.2.3 An incident / complaints register will be created into which incidents / complaints can be recorded. Once entered, the incident / complaint will be dealt with using the normal procedures that the main contractor has in place for its development site construction works.

7.2.4 As well as planning and co-ordinating the day-to-day site deliveries, on-site arrangements to accommodate delivery vehicles and the arrangements for special deliveries, the Logistics Manager will liaise with nominated representatives of the Applicant other on-going construction projects to agree, where practical to do so, consolidation of vehicle activity and other measures to support the running of the Detailed CLP. The Logistics Manager will also liaise regularly with key personnel at the local authority, local residents and groups.

7.2.5 The Detailed CLP will be a 'live' document and will be regularly reviewed with key stakeholders and updated throughout the project's construction. The Detailed CLP will be reviewed no less than annually.

Appendix A Context Maps

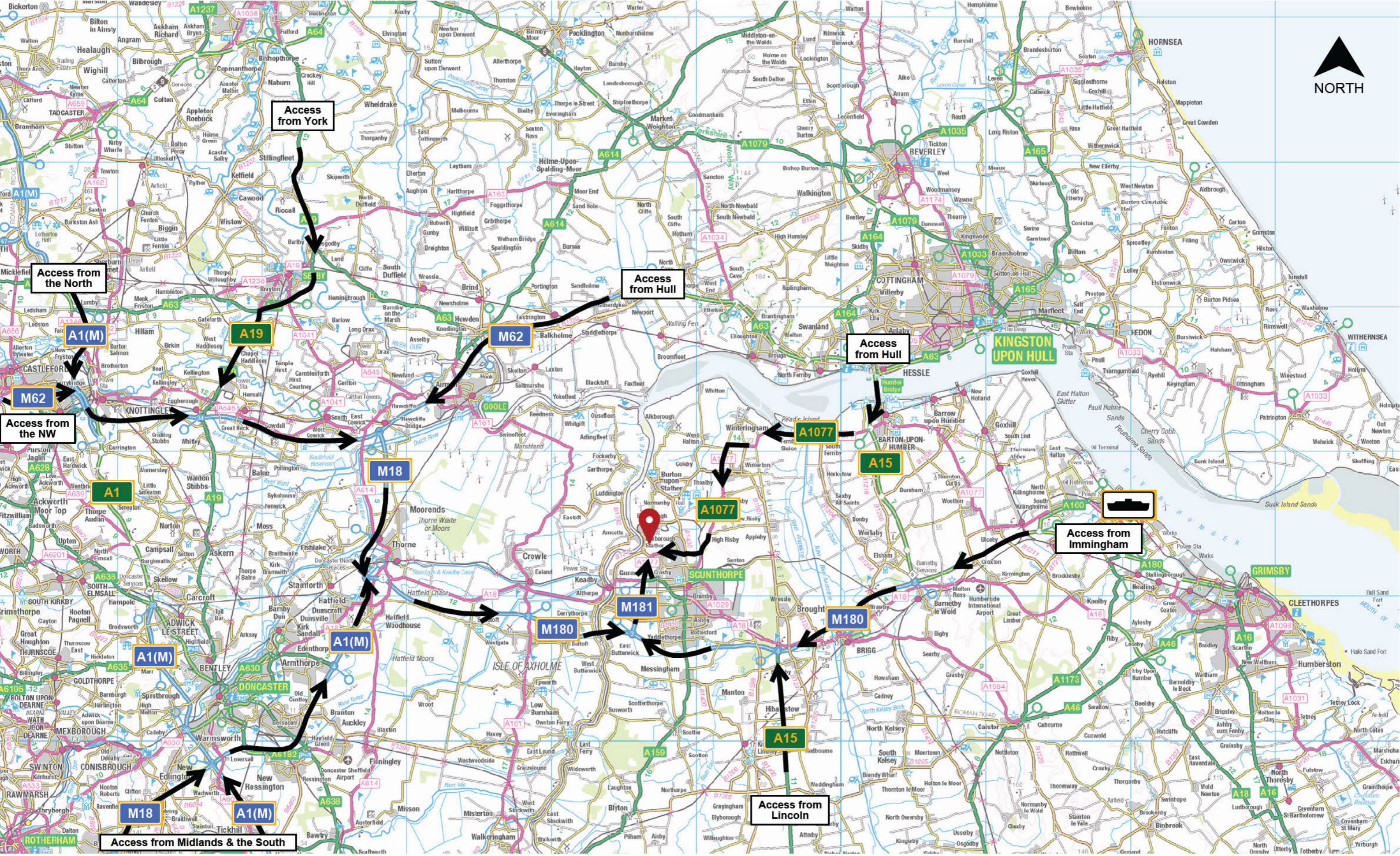

Contains OS data © Crown copyright and database right 2021

	Project:	North Lincolnshire Green Energy Park (NLGEP)		Project Number:	0046658		Status:	For information			
	Sketch Title:	Context - strategic highways connections (not to scale)		Sketch Number:	0046658-2318-CLP-SK0010		Date:	01/04/21	Initials:	NJH	Revision:

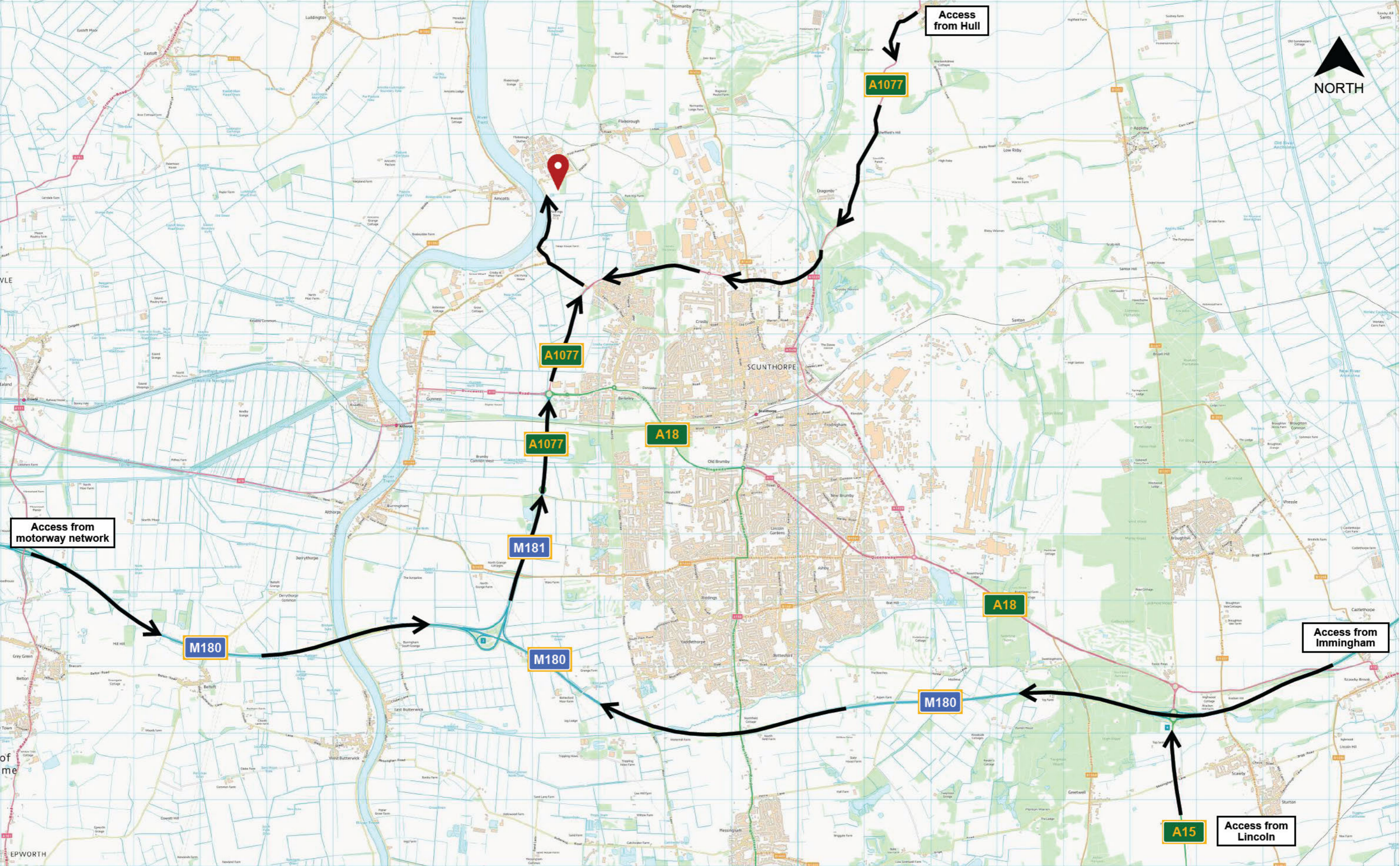

Contains OS data © Crown copyright and database right 2021

	Project:	North Lincolnshire Green Energy Park (NLGEP)	Project Number:	0046658	Status:	For information	
	Sketch Title:	Context - existing regional highways connections (not to scale)	Sketch Number:	0046658-2318-CLP-SK0020	Date:	07/10/21	Revision:
					Initials:	NJH	

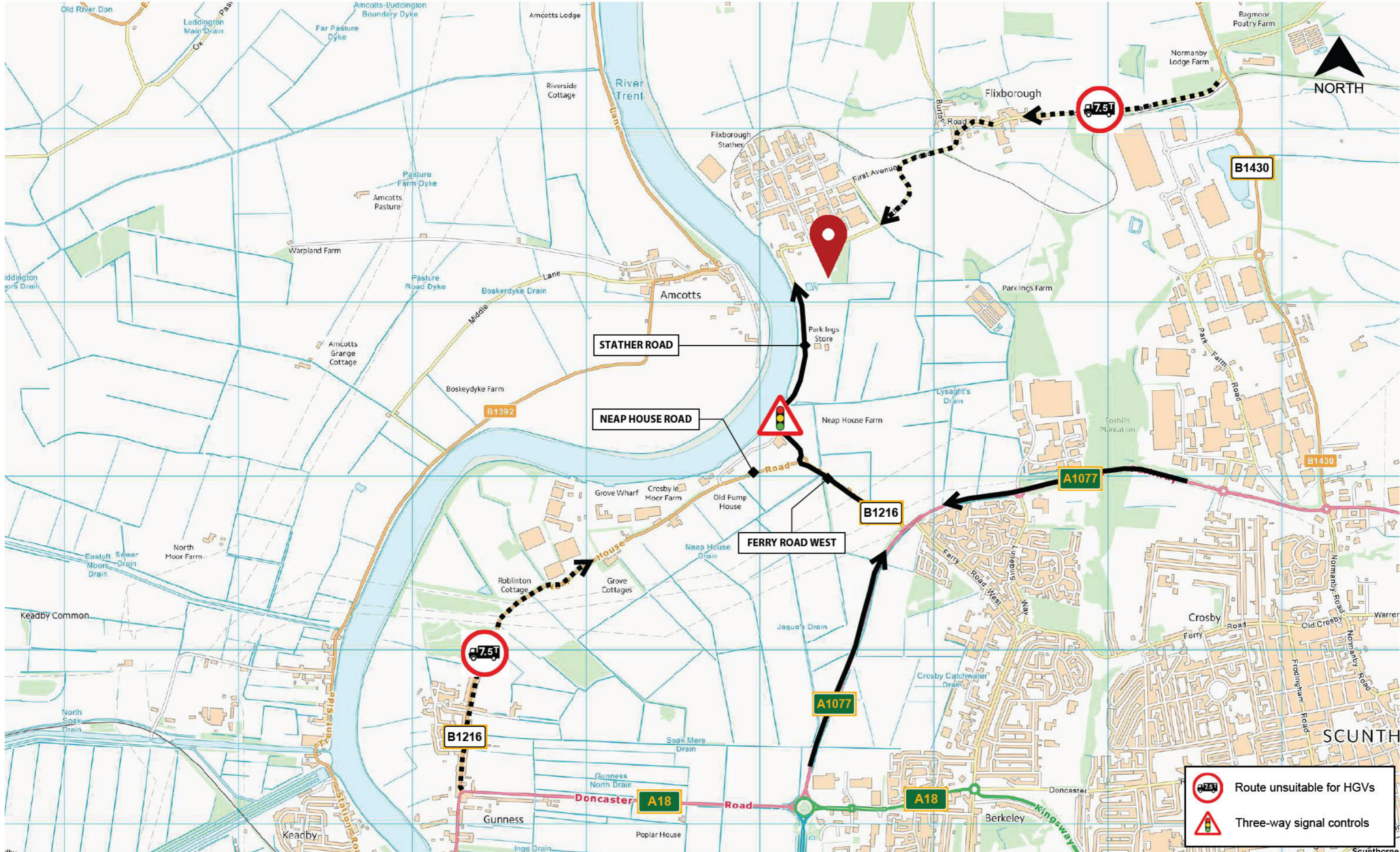

Contains OS data © Crown copyright and database right 2021

	Project:	North Lincolnshire Green Energy Park (NLGEP)	Project Number:	0046658	Status:	For information			
	Sketch Title:	Context - existing local highways connections (not to scale)	Sketch Number:	0046658-2318-CLP-SK0030	Date:	01/04/21	Initials:	NJH	Revision:

this page is intentionally blank

Appendix B Preliminary Construction Programme

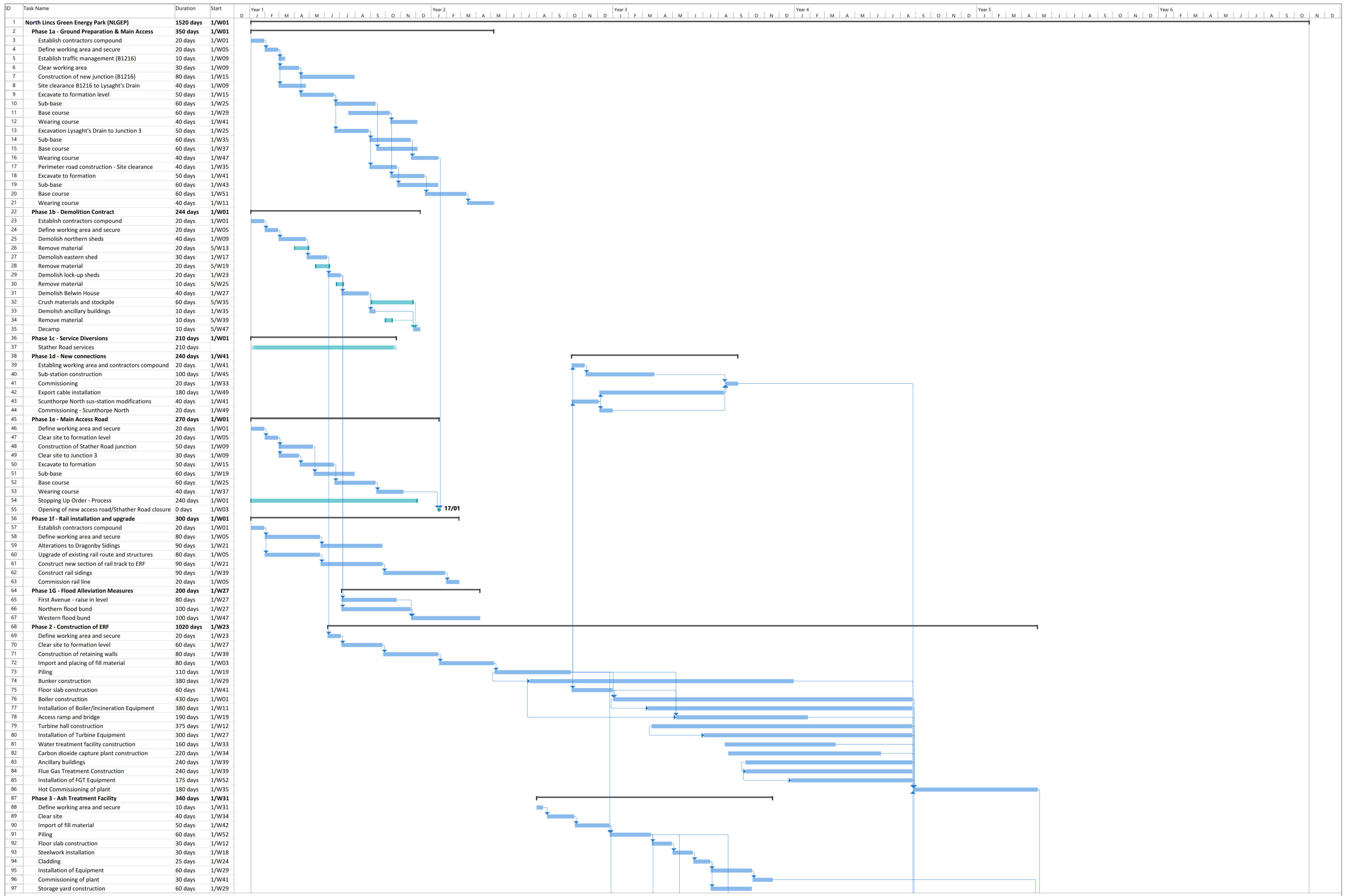

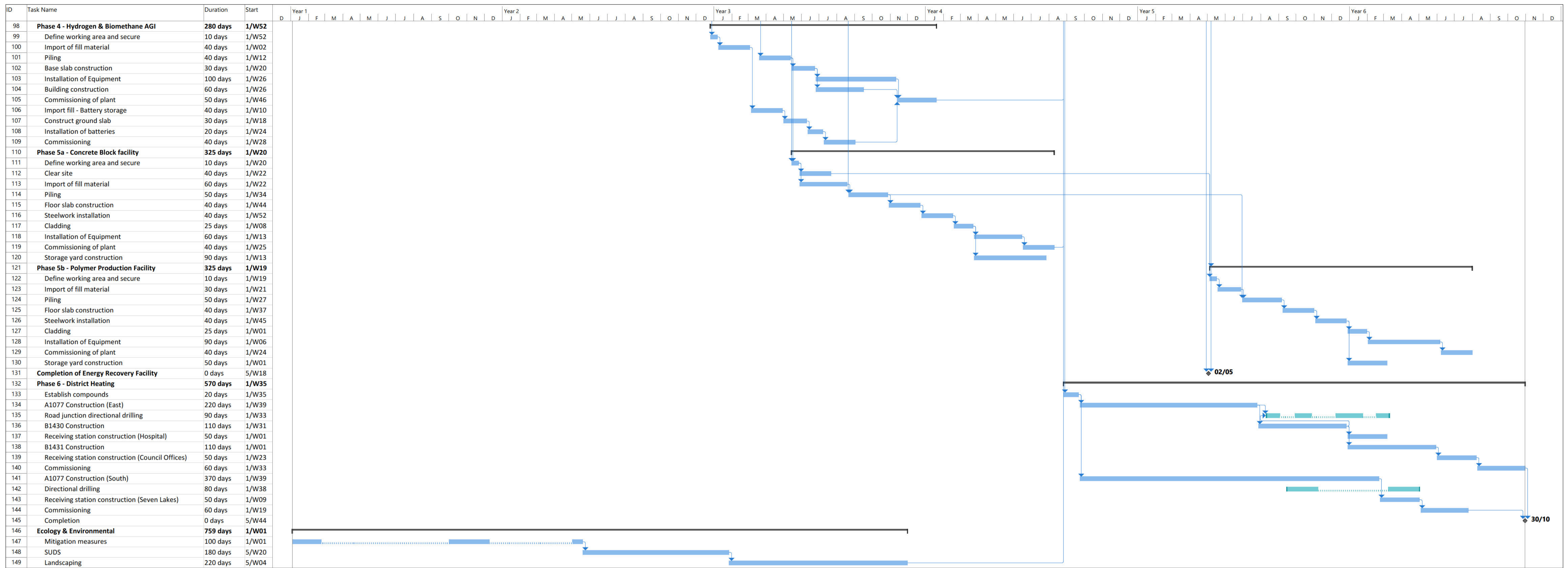

this page is intentionally blank

Appendix C Preliminary Phasing Plans

North Lincolnshire Green Energy Park

Indicative Phasing Strategy

Phasing Strategy Workbook



Kit of Parts

- 1 Energy Recovery Facility (ERF);
- 2 Carbon capture, utilisation and storage;
- 3 Bottom ash and Flue Gas Residue Handling and Treatment Facility (RHTF);
- 4 Concrete Block Manufacturing Facility (CBMF);
- 5 Plastic Recycling Facility (PRF);
- 6 Electric Vehicle (EV) and hydrogen (H2) re-fuelling station;
- 7 Hydrogen and natural gas above ground installation (AGI);
- 8 Hydrogen production and storage facility;
- 9 Battery Storage;
- 10 New railway works including, sidings at Dragonby, re-instatement and safety improvements to the 6km private spur, and construction of a new railhead with sidings south of Flixborough Wharf;
- 11 New access road and parking;
- 12 Gatehouse and visitor centre with elevated walkway;
- 13 A north and south district heating and private wire network (DHPWN); and
- 14 Switchyard.

Indicative Construction Programme

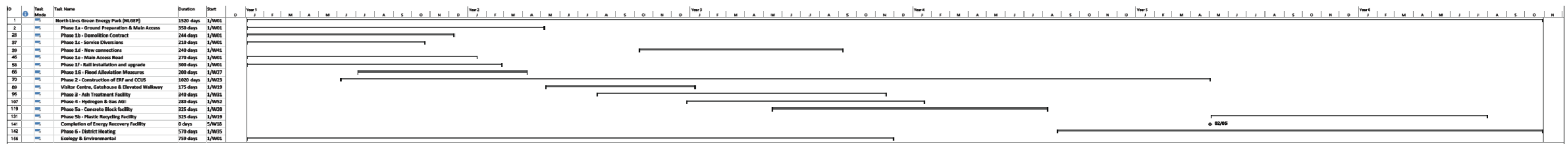

Indicative Phasing Strategy

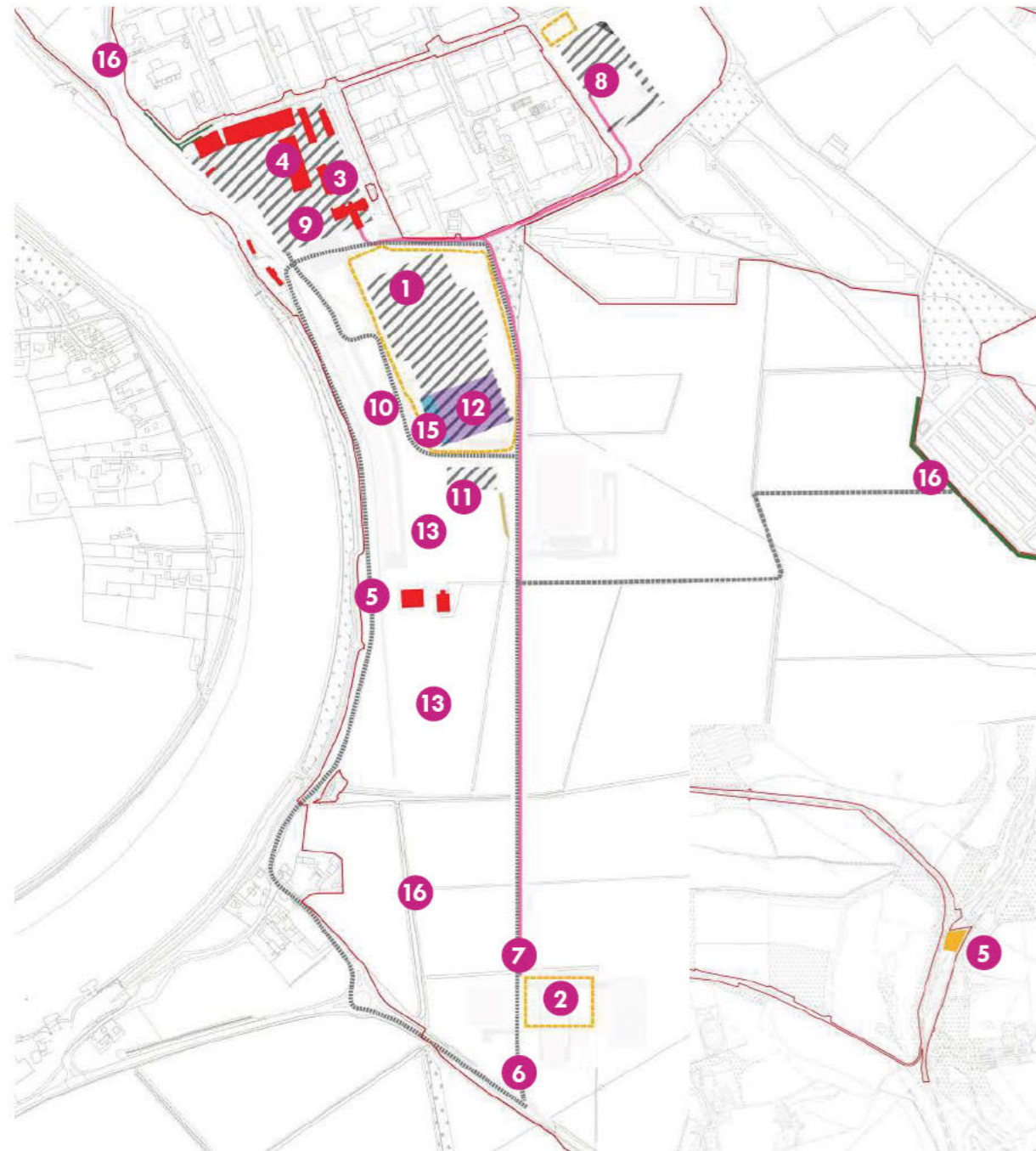

- Key:
- Construction Compound/laydown
 - Buildings to be demolished
 - Extent of site clearance
 - Temporary Construction Welfare
 - Temporary Car Parking
 - District heating and private wire network
 - Flooding bund/walls and gate

Phase 1 - 18 months

- 1** Establish main Contractors compound on existing hard standing, south of Stather Road. In parallel relocate RMS Ports to the northern part of their ownership boundary and establish their main access off First Avenue.
- 2** Establish secondary Contractors compound to the north east of new junction on B1216.
- 3** Demolition contractor to set up on former Belwin House land.
- 4** Commence site clearance and demolition work for Energy Recovery Facility.
- 5** Establish Dragonby sidings construction compound and commence railhead construction upgrade.
- 6** Commence construction of new junction on B1216.
- 7** Commence clearance and construction of new access road from B1216 to Stather Road (south to north) including utility corridors. Install section of District Heating and Private Wire Network along new access road at this point.
- 8** Commence new electrical grid connection and private wire network. Commence earthworks for electrical substation infrastructure.
- 9** Carry out service diversion.
- 10** Construct internal access road.
- 11** Construction of gate house and visitor centre.
- 12** Construct temporary car park for up to 500 vehicles.
- 13** Construction of attenuation ponds, swales and realignment of ditches.
- 14** Advance planting and ecology works.
- 15** Undertake earthworks and establish temporary construction welfare facility.
- 16** Clearance of existing vegetation and construction of flooding bund around chicken farm and along First Avenue and within the wetlands.

Phase 2 - 4 years

- 1 New access road adopted
- 2 Import fill material.
- 3 Pile foundations.
- 4 Construct ground slab/turbine and boiler blocks.
- 5 Construct access ramp.
- 6 Construct superstructure.
- 7 Fit out and commission.
- 8 Construct electrical substation infrastructure

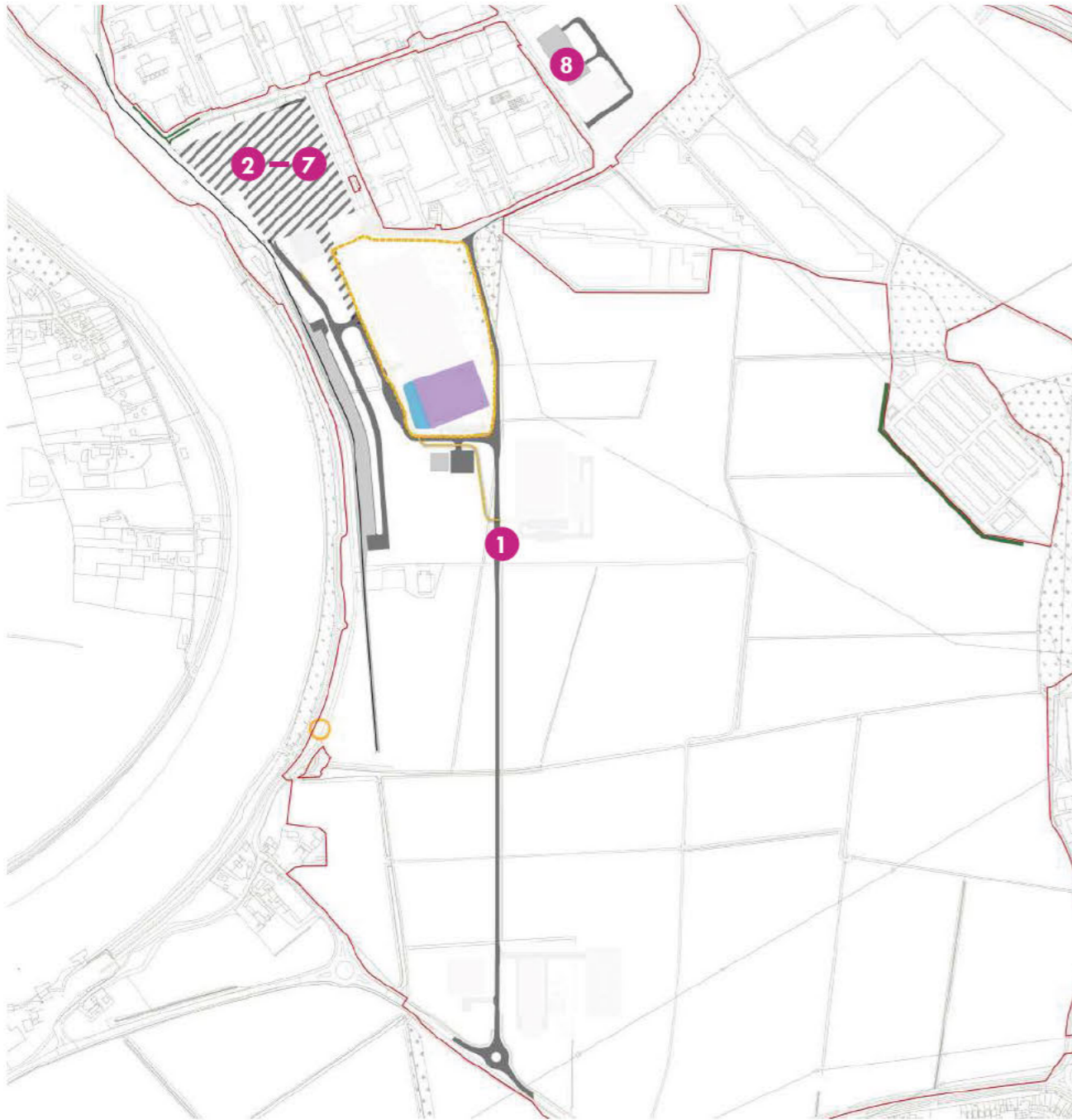

Key:

-  Construction Compound/laydown
-  Areas of earthworks and construction
-  Temporary Construction Welfare
-  Temporary Car Parking
-  Stather Road Stopped Up
-  Flooding bund/walls and gate

Phasing Strategy

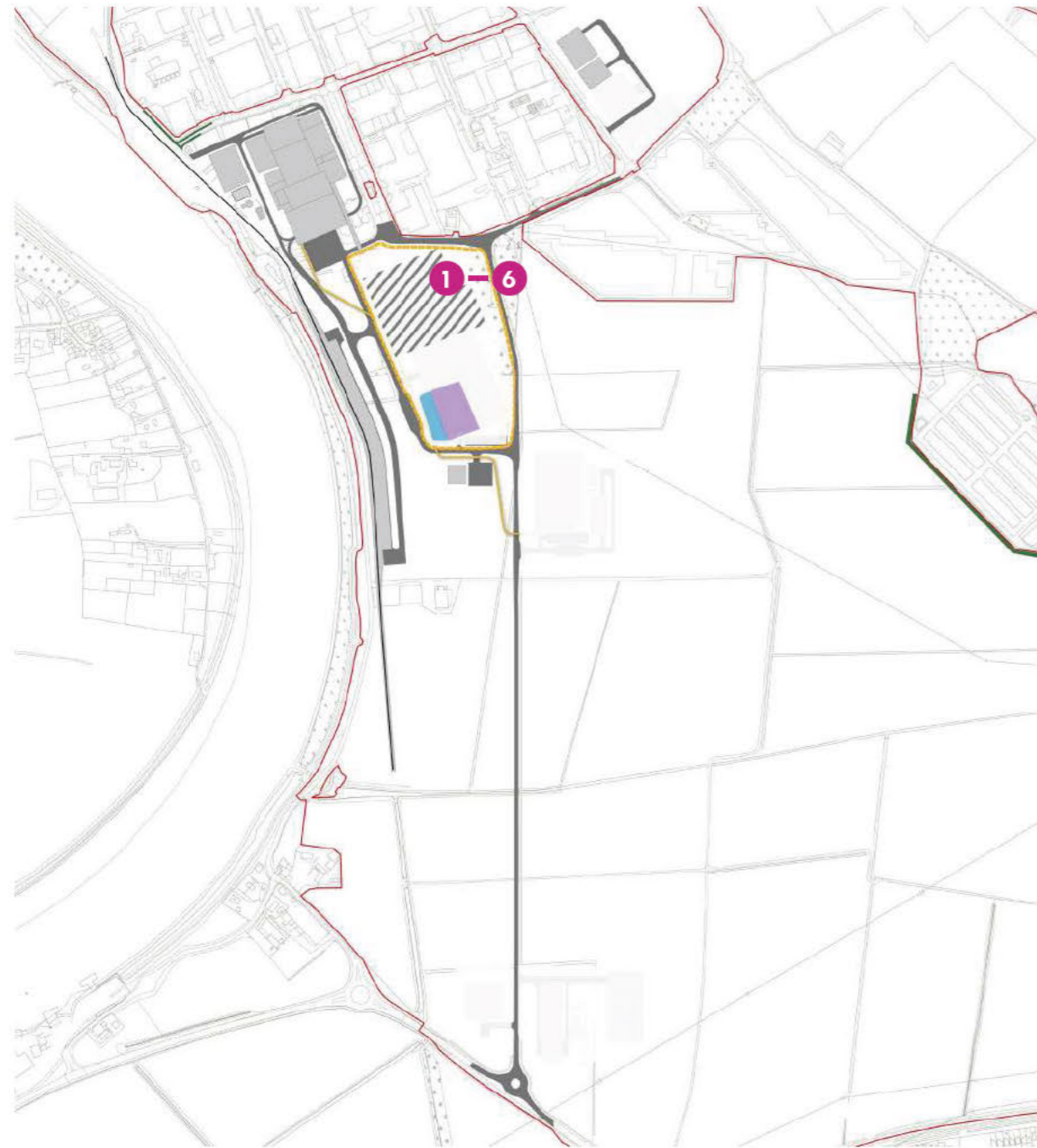

Phase 3 - 16months

- 1 Clear site for bottom ash and flue gas residue handling and treatment facility.
- 2 Import fill material.
- 3 Pile foundations.
- 4 Construct ground slab.
- 5 Construct superstructure.
- 6 Fit out and commission.

Key:

- Construction Compound/laydown
- Areas of earthworks and construction
- Temporary Construction Welfare
- Temporary Car Parking
- Flooding bund/walls and gate

Phase 4 - 1 year

- 1 Clear site for an electric vehicle (EV) and hydrogen (H₂) re-fuelling station, a hydrogen and natural gas above ground installation (AGI), a hydrogen production and storage facility and battery storage.
- 2 Import fill material.
- 3 Pile foundations.
- 4 Construct ground slab.
- 5 Construct superstructure.
- 6 Fit out and commission
- 7 Construct hydrogen and natural gas above ground installation (AGI).



Key:

- Construction Compound/laydown
- Areas of earthworks and construction
- Flooding bund/walls and gate

Indicative Phasing Strategy

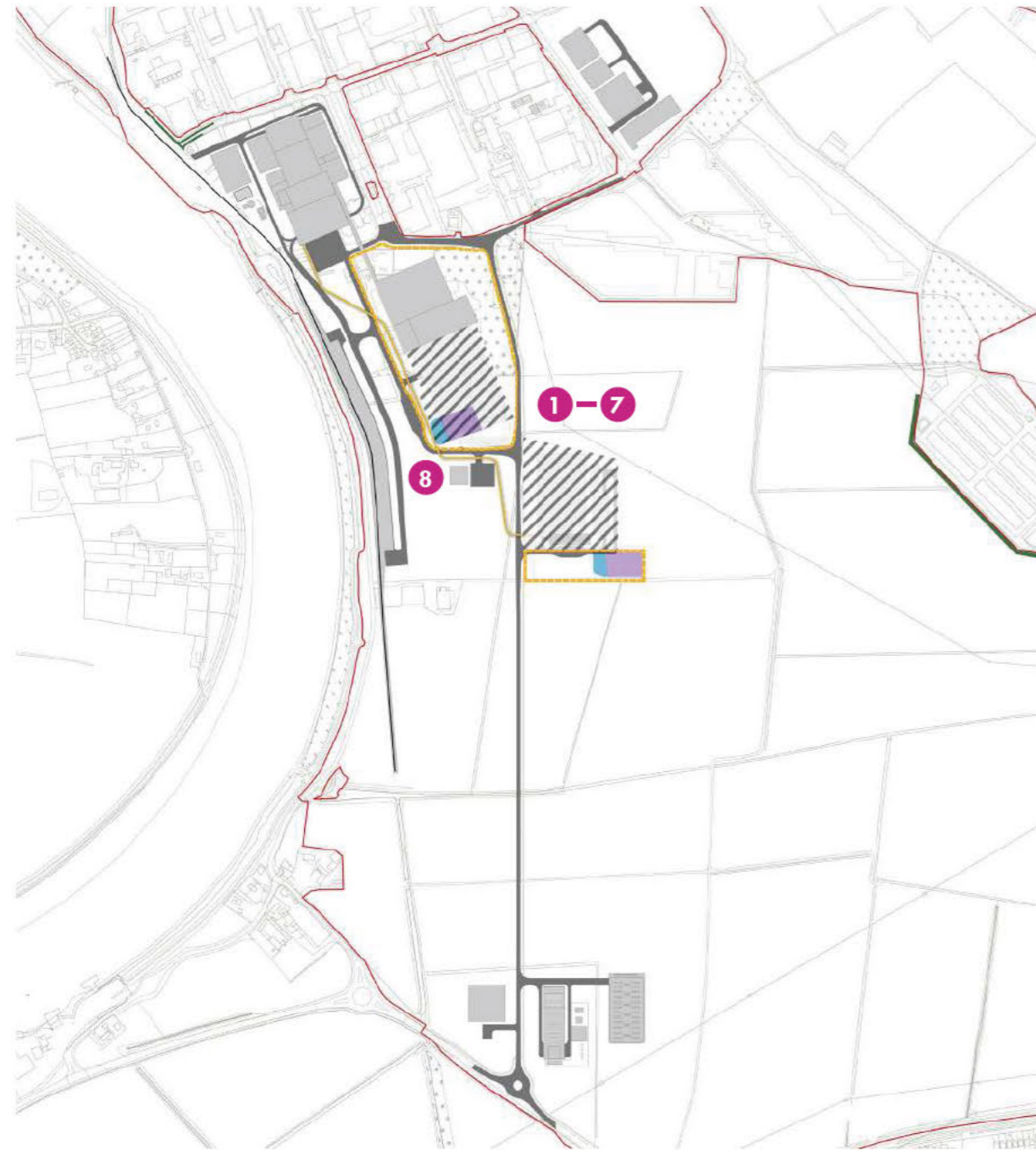

Key:

- Construction Compound/laydown
- Areas of earthworks and construction
- Temporary Construction Welfare
- Temporary Car Parking
- Elevated walkway
- Flooding bund/walls and gate

Phase 5 - 1.5 years

- 1 Establish temporary construction compound for the Concrete Block Manufacturing Facility and Plastic Recycling Facility.
- 2 Clear sites for the Concrete Block Manufacturing Facility and Plastic Recycling Facility.
- 3 Import fill material.
- 4 Pile foundations.
- 5 Construct ground slab.
- 6 Construct superstructure.
- 7 Fit out and commission.
- 8 Construct elevated walkway.

Phase 6 - 2 years

- 1 Establish temporary construction compounds.
- 2 Commence site clearance on agreed route (easement).
- 3 Install north and south district district heating and private wire network and reinstate.
- 4 Commission.

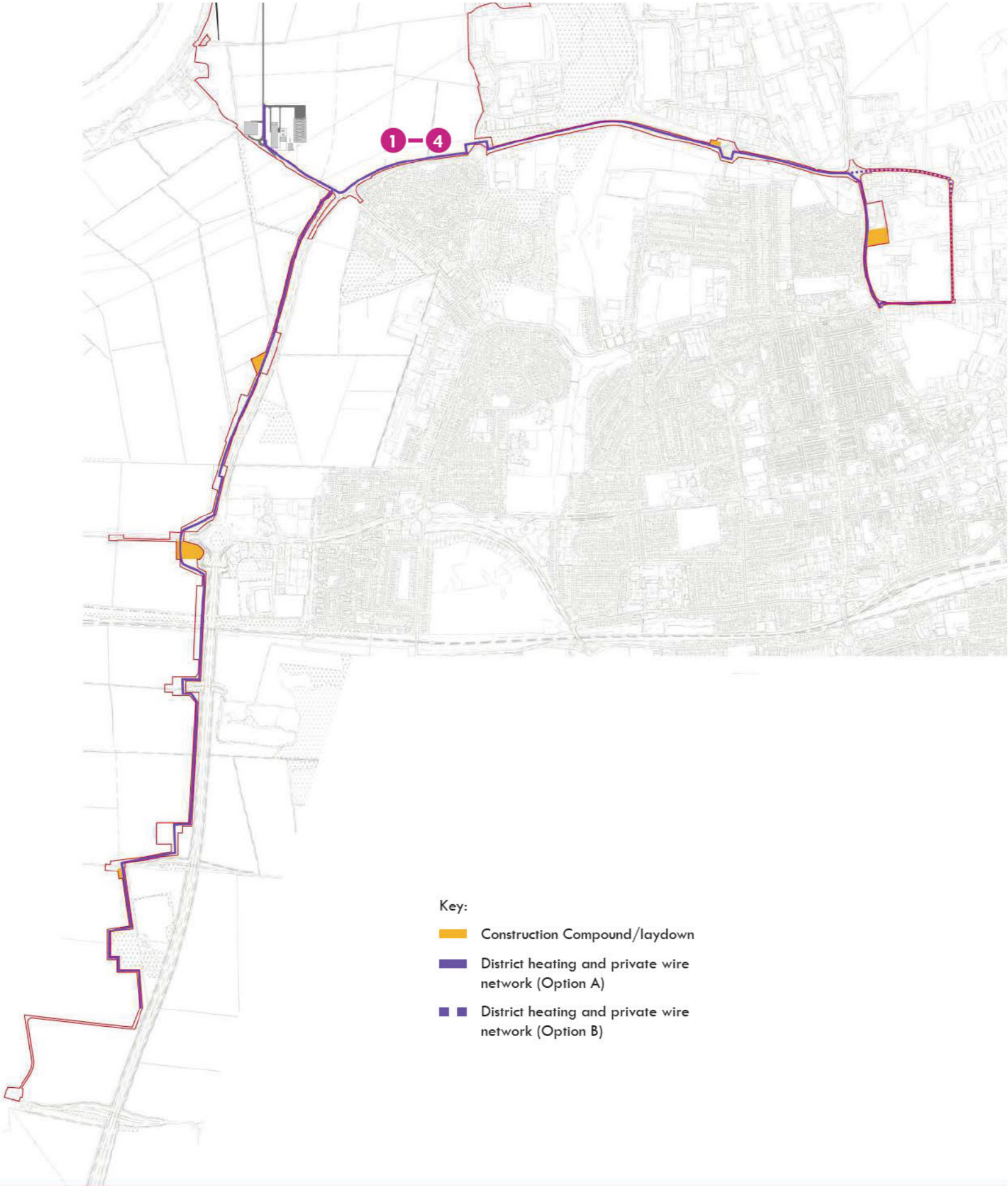

this page is intentionally blank

Appendix D Construction Traffic Routing Maps

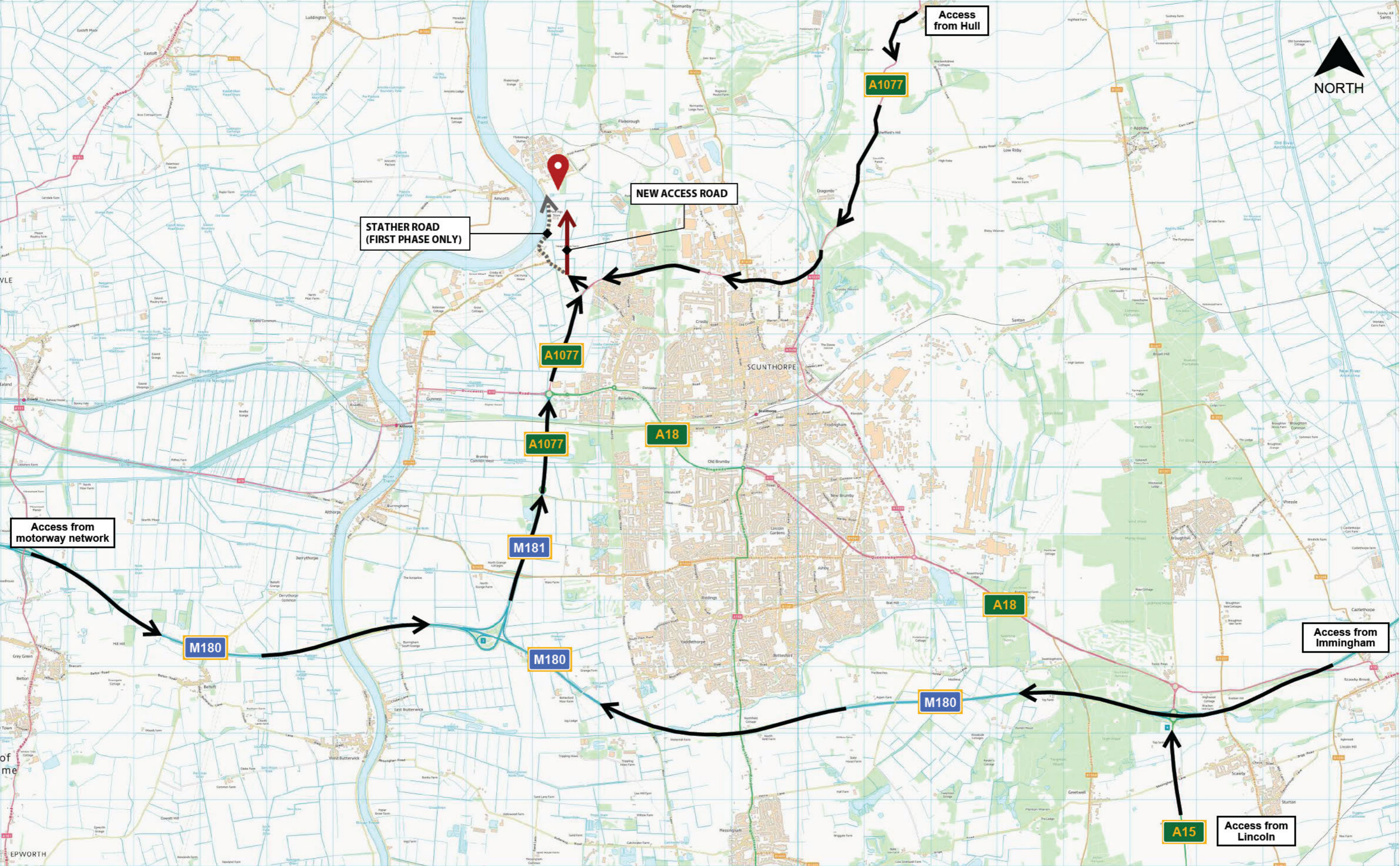

Contains OS data © Crown copyright and database right 2021

	Project:	North Lincolnshire Green Energy Park (NLGEP)	Project Number:	0046658	Status:	For information				
	Sketch Title:	Proposed construction traffic access - regional highways connections (not to scale)		Sketch Number:	0046658-2318-CLP-SK0040	Date:	07/10/21	Initials:	NJH	Revision:

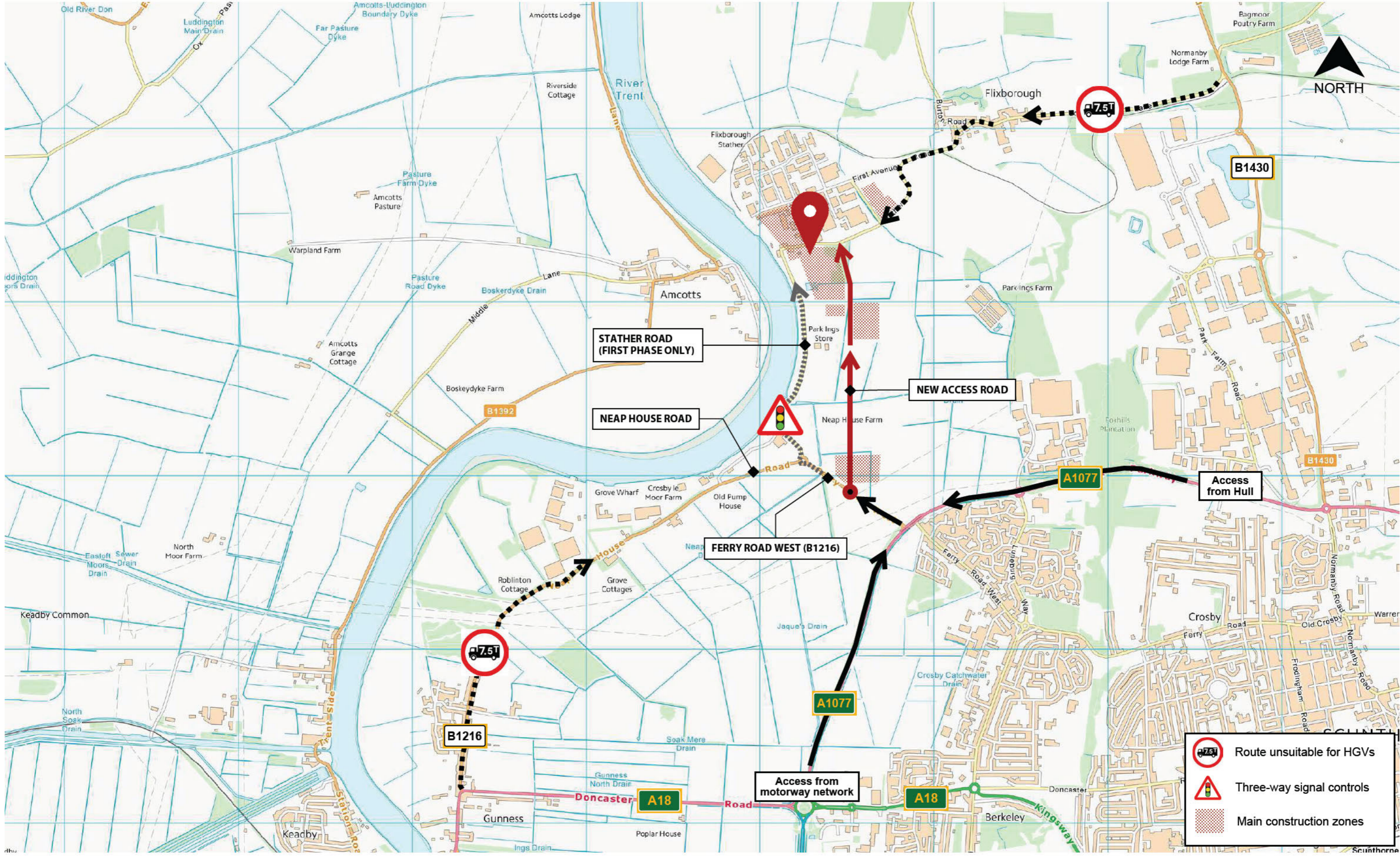

Contains OS data © Crown copyright and database right 2021

	Project:	North Lincolnshire Green Energy Park (NLGEP)	Project Number:	0046658	Status:	For information			
	Sketch Title:	Proposed construction traffic access - local highways connections (not to scale)	Sketch Number:	0046658-2318-CLP-SK0050	Date:	01/04/21	Initials:	NJH	Revision:

this page is intentionally blank

Appendix E PRow Crossings

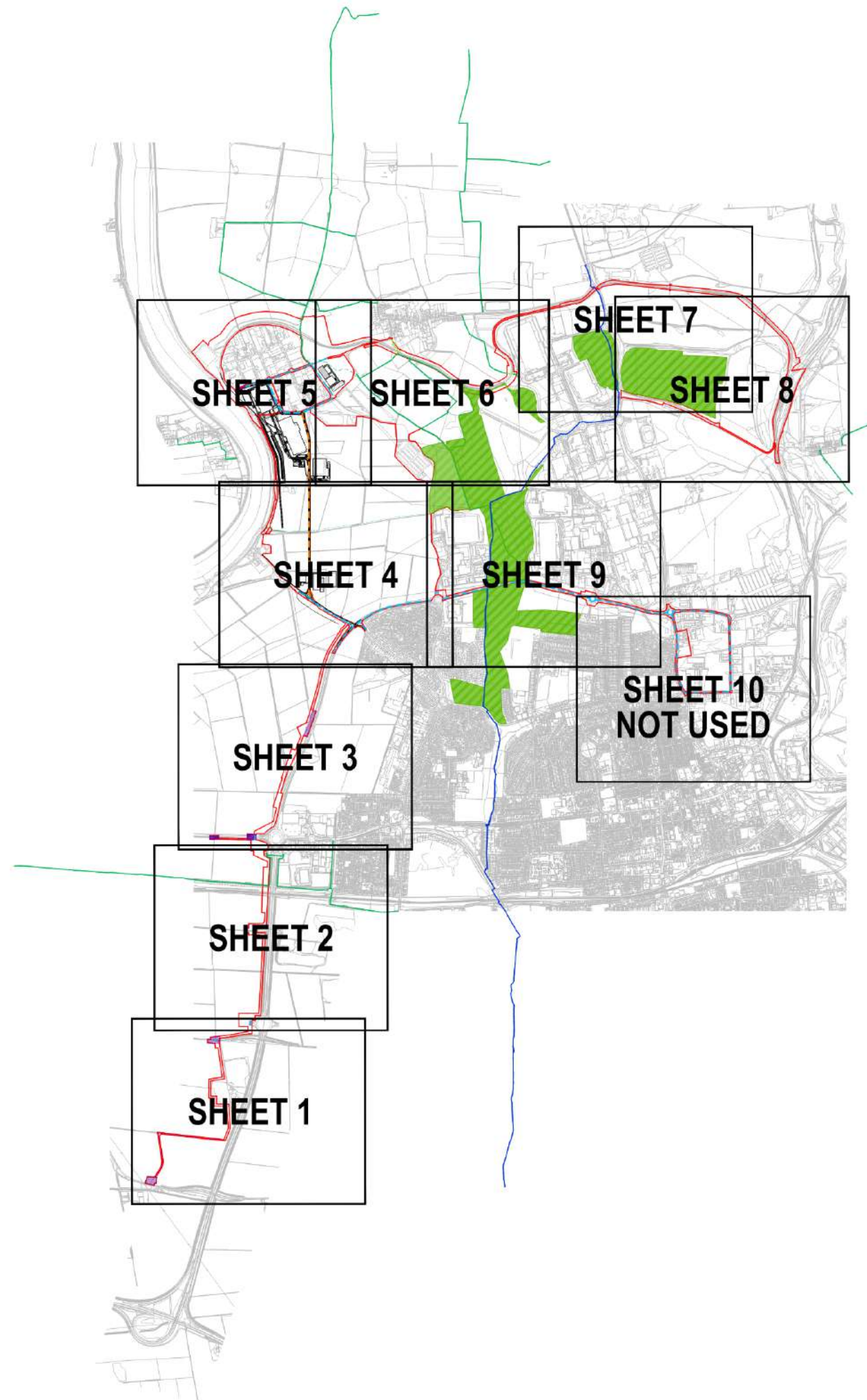
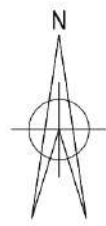

NOTES:

1. THIS DRAWING SHOULD BE READ IN CONJUNCTION WITH ALL OTHER RELEVANT DRAWINGS AND SPECIFICATIONS
2. DRAWINGS BASED ON THE FOLLOWING BACKGROUND INFORMATION:
 - ORDNANCE SURVEY MAPS RECEIVED © CROWN COPYRIGHT AND DATABASE RIGHTS 2021 OS LICENCE 100035409
3. THE COMPLETENESS OF THE UNDERGROUND SERVICE INFORMATION CANNOT BE GUARANTEED AND THEREFORE OTHER SERVICES MAY EXIST.

LEGEND

- PROPOSED**
- SITE BOUNDARY
 - PROPOSED STREET WORKS
 - EXISTING PROW
 - PROPOSED HIGHWAY
 - PROPOSED PEDESTRIAN-CYCLE PATHS
 - PROPOSED PEDESTRIAN PATHS
 - PROPOSED STRATEGIC PEDESTRIAN-CYCLE ROUTE
 - EXISTING NATIONAL CYCLE NETWORK
 - HIGHWAYS TO BE STOPPED UP
 - IMPROVEMENT TO EXISTING PRIVATE ACCESS TRACKROAD
 - IMPROVEMENT TO EXISTING PRIVATE MEANS OF ACCESS
 - NEW TEMPORARY PRIVATE ACCESS TRACKROAD
 - NEW TEMPORARY PRIVATE MEANS OF ACCESS
 - OPEN SPACE
 - EXISTING PROW/CYCLEWAY TO BE TEMPORARILY DIVERTED OR STOPPED UP (E)
 - PRIVATE ACCESS TO BE STOPPED UP (C)
 - NEW PRIVATE MEANS OF ACCESS (D)

KEY:

- A - HIGHWAY STOPPING UP
- B - PROPOSED HIGHWAYS
- C - PRIVATE ACCESS TO BE STOPPED UP
- D - NEW PRIVATE MEANS OF ACCESS
- E - EXISTING PROW/CYCLEWAY TEMPORARILY DIVERTED/STOPPED UP
- FP - PROPOSED FOOTPATH
- CCF - PROPOSED COMBINED CYCLE FOOTPATH
- SW - PROPOSED STREET WORKS

PD	ISSUED FOR DCO SUBMISSION	02.03.2022	FR	CB	CB
Rev	Description	Date	Issd	Rev'd	App'd

DCO SUBMISSION

Project Stage

INFORMATION

Status of Drawing

Client:

Level 33, Euston Tower, 205 Euston Road, London, NW1 2DP

LD&A DESIGN GSDA FICHTNER ERM

EURO HAPFOLD northern planners bowland ecology

Client: NORTH LINCOLNSHIRE GREEN ENERGY PARK LTD
 Consultant: BURO HAPFOLD
 Project: NORTH LINCOLNSHIRE GREEN ENERGY PARK
 Dwg Title: RIGHTS OF WAY AND ACCESS PLAN OVERALL SHEET

Planning Inspectorate No:	Scale @A1	
EN010116	1:20000	
Drawn/Designed By:	Checked By:	Approved By:
J.SLEEMAN	C.BYRNE	C.BYRNE
Drawing No:	Revision	
NLGP-BHE-XX-XX-DR-C-2100	PO	



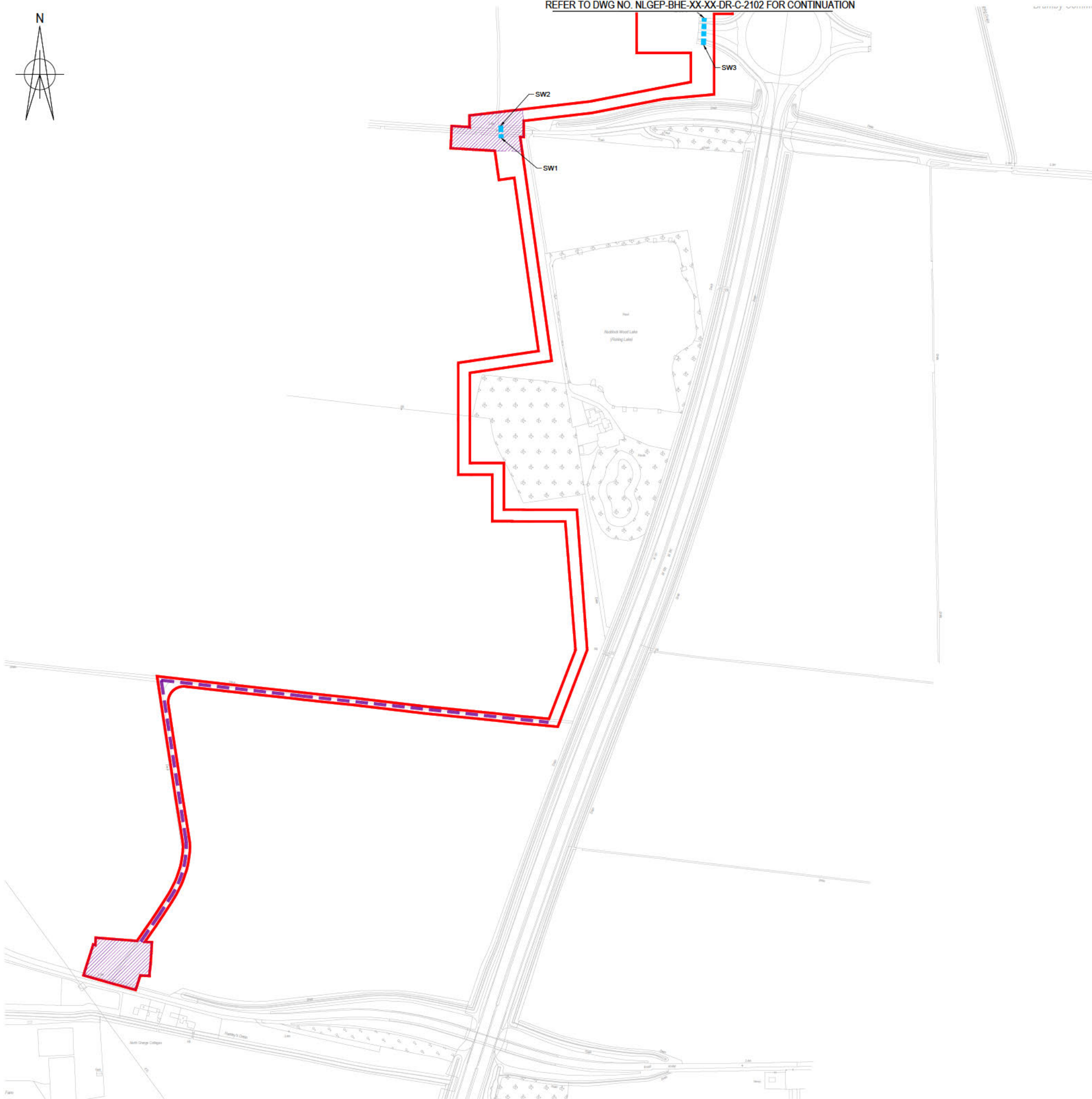
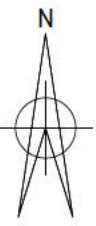

Planning Act 2008
The Infrastructure Planning (Applications: Prescribed Forms and Procedure) Regulations 2008
Regulation: 5(2)(k)

- NOTES:**
- THIS DRAWING SHOULD BE READ IN CONJUNCTION WITH ALL OTHER RELEVANT DRAWINGS AND SPECIFICATIONS.
 - DRAWINGS BASED ON THE FOLLOWING BACKGROUND INFORMATION:
 - ORDNANCE SURVEY MAPS RECEIVED @ CROWN COPYRIGHT AND DATABASE RIGHTS 2021 OS LICENCE 100035409
 - THE COMPLETENESS OF THE UNDERGROUND SERVICE INFORMATION CANNOT BE GUARANTEED AND THEREFORE OTHER SERVICES MAY EXIST.

LEGEND

PROPOSED

- SITE BOUNDARY
- PROPOSED STREET WORKS
- EXISTING PROW
- PROPOSED HIGHWAY
- PROPOSED PEDESTRIAN-CYCLE PATHS
- PROPOSED PEDESTRIAN PATHS
- PROPOSED STRATEGIC PEDESTRIAN-CYCLE ROUTE
- EXISTING NATIONAL CYCLE NETWORK
- HIGHWAYS TO BE STOPPED UP
- IMPROVEMENT TO EXISTING PRIVATE ACCESS TRACK/ROAD
- IMPROVEMENT TO EXISTING PRIVATE MEANS OF ACCESS
- NEW TEMPORARY PRIVATE ACCESS TRACK/ROAD
- NEW TEMPORARY PRIVATE MEANS OF ACCESS
- OPEN SPACE
- EXISTING PROW/CYCLEWAY TO BE TEMPORARILY DIVERTED OR STOPPED UP (E)
- PRIVATE ACCESS TO BE STOPPED UP (C)
- NEW PRIVATE MEANS OF ACCESS (D)

KEY:

- A - HIGHWAY STOPPING UP
- B - PROPOSED HIGHWAYS
- C - PRIVATE ACCESS TO BE STOPPED UP
- D - NEW PRIVATE MEANS OF ACCESS
- E - EXISTING PROW/CYCLEWAY TEMPORARILY DIVERTED/STOPPED UP
- FP - PROPOSED FOOTPATH
- CCF - PROPOSED COMBINED CYCLE FOOTPATH
- SW - PROPOSED STREET WORKS

PD	ISSUED FOR DCO SUBMISSION	02.03.2022	FR	CB	CB
Rev	Description	Date	Issd	Rev'd	App'd

DCO SUBMISSION

Project Stage

INFORMATION

Status of Drawing

Client

Level 33, Euston Tower, 206 Euston Road, London, NW1 2DP

LD A DESIGN **GSDA** **FICHTNER**
ERM

BURO HAPFOLD **northern planners** **bowland ecology** **engineering**

Client: NORTH LINCOLNSHIRE GREEN ENERGY PARK LTD
Consultant: BURO HAPFOLD
Project: NORTH LINCOLNSHIRE GREEN ENERGY PARK
Doc Title: RIGHTS OF WAY AND ACCESS PLAN SHEET 1

Planning Inspectorate No. EN010116	Scale@A1 1:2500	
Drawn/Designed By: J.SLEEMAN	Checked By: C.BYRNE	Approved By: C.BYRNE
Drawing No. NLGEP-BHE-XX-XX-DR-C-2101	Revision PO	

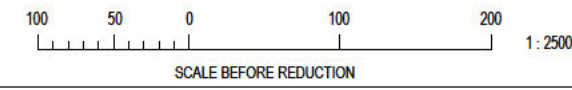

REFER TO DWG NO. NLGEP-BHE-XX-XX-DR-C-2103 FOR CONTINUATION

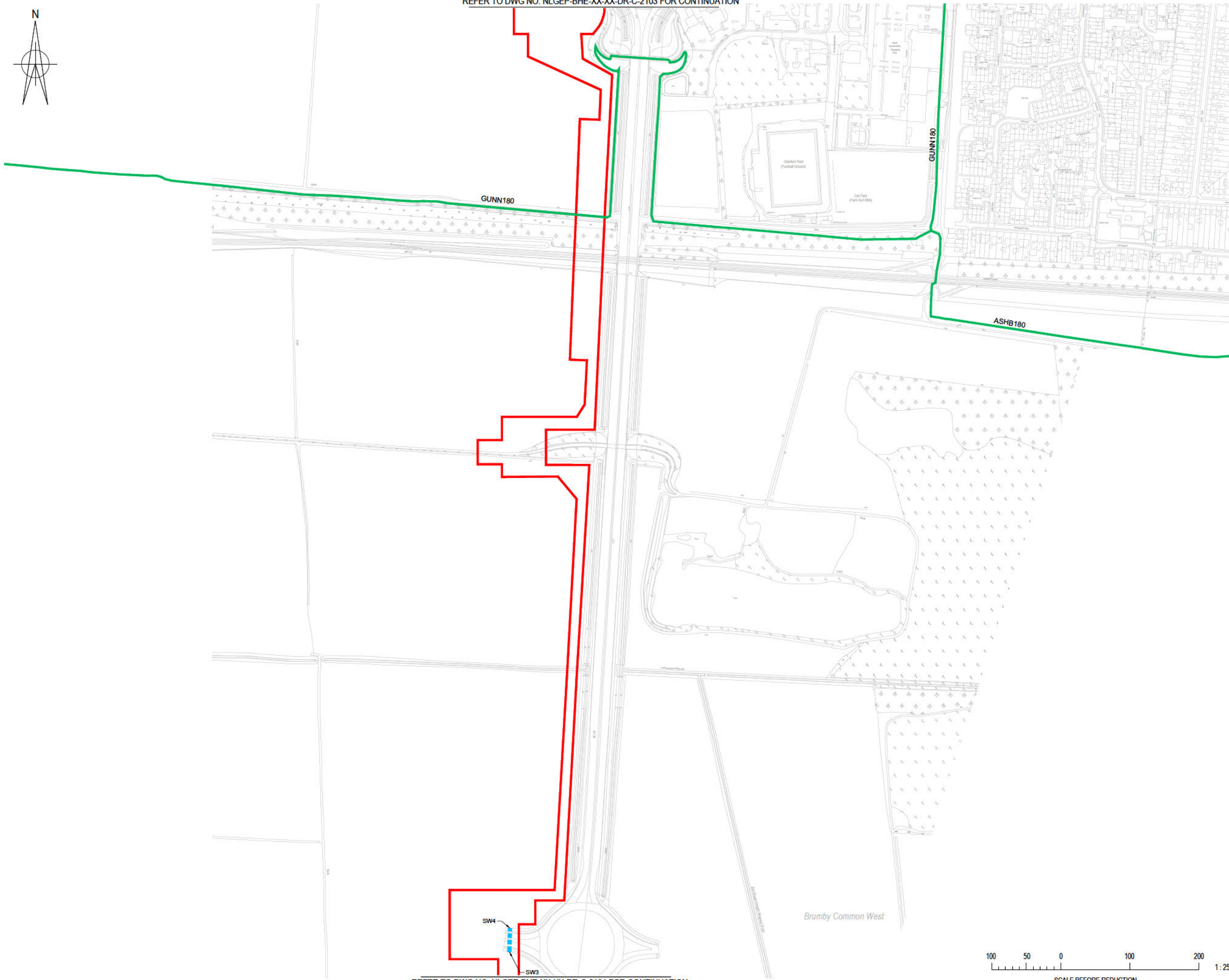

REFER TO DWG NO. NLGEP-BHE-XX-XX-DR-C-2101 FOR CONTINUATION

Planning Act 2008
The Infrastructure Planning (Applications: Prescribed Forms and Procedure) Regulations 2008
Regulation: 5(2)(k)

- NOTES:**
- THIS DRAWING SHOULD BE READ IN CONJUNCTION WITH ALL OTHER RELEVANT DRAWINGS AND SPECIFICATIONS.
 - DRAWINGS BASED ON THE FOLLOWING BACKGROUND INFORMATION:
 - ORDNANCE SURVEY MAPS RECEIVED © CROWN COPYRIGHT AND DATABASE RIGHTS 2021 OS LICENCE 100035409
 - THE COMPLETENESS OF THE UNDERGROUND SERVICE INFORMATION CANNOT BE GUARANTEED AND THEREFORE OTHER SERVICES MAY EXIST.

- LEGEND**
- PROPOSED**
- SITE BOUNDARY
 - PROPOSED STREET WORKS
 - EXISTING PROW
 - PROPOSED HIGHWAY
 - PROPOSED PEDESTRIAN-CYCLE PATHS
 - PROPOSED PEDESTRIAN PATHS
 - PROPOSED STRATEGIC PEDESTRIAN-CYCLE ROUTE
 - EXISTING NATIONAL CYCLE NETWORK
 - HIGHWAYS TO BE STOPPED UP
 - IMPROVEMENT TO EXISTING PRIVATE ACCESS TRACKROAD
 - IMPROVEMENT TO EXISTING PRIVATE MEANS OF ACCESS
 - NEW TEMPORARY PRIVATE ACCESS TRACKROAD
 - NEW TEMPORARY PRIVATE MEANS OF ACCESS
 - OPEN SPACE
 - EXISTING PROW/CYCLEWAY TO BE TEMPORARILY DIVERTED OR STOPPED UP (E)
 - PRIVATE ACCESS TO BE STOPPED UP (C)
 - NEW PRIVATE MEANS OF ACCESS (D)

- KEY:**
- A - HIGHWAY STOPPING UP
 - B - PROPOSED HIGHWAYS
 - C - PRIVATE ACCESS TO BE STOPPED UP
 - D - NEW PRIVATE MEANS OF ACCESS
 - E - EXISTING PROW/CYCLEWAY TEMPORARILY DIVERTED/STOPPED UP
 - FP - PROPOSED FOOTPATH
 - CCF - PROPOSED COMBINED CYCLE FOOTPATH
 - SW - PROPOSED STREET WORKS

PD	ISSUED FOR DCO SUBMISSION	02.03.2022	FR	CB	CB
Rev	Description	Date	Issd	Rev'd	App'd

DCO SUBMISSION

Project Stage

INFORMATION

Status of Drawing

Client

Level 33, Euston Tower, 206 Euston Road, London, NW1 2DP

LD A DESIGN GSDA FICHTNER ERM

BURO HAPFOLD northern planners bowland ecology

Client: NORTH LINCOLNSHIRE GREEN ENERGY PARK LTD
 Consultant: BURO HAPFOLD
 Project: NORTH LINCOLNSHIRE GREEN ENERGY PARK
 Title: RIGHTS OF WAY AND ACCESS PLAN SHEET 2

Planning Inspectorate No. EN010116	Scale@1 1:2500	
Drawn/Designed By: J.SLEEMAN	Checked By: C.BYRNE	Approved By: C.BYRNE
Drawing No. NLGEP-BHE-XX-XX-DR-C-2102	Revision PO	

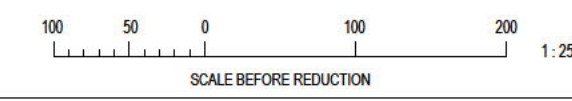

Project: NLGEP-BHE-XX-XX-DR-C-2102-Access Plan Sheet 2
 Drawing: NLGEP-BHE-XX-XX-DR-C-2102-Access Plan Sheet 2
 Date: 02/03/2022
 Scale: 1:2500
 Author: J.SLEEMAN
 Checker: C.BYRNE
 Approver: C.BYRNE
 Revision: PO

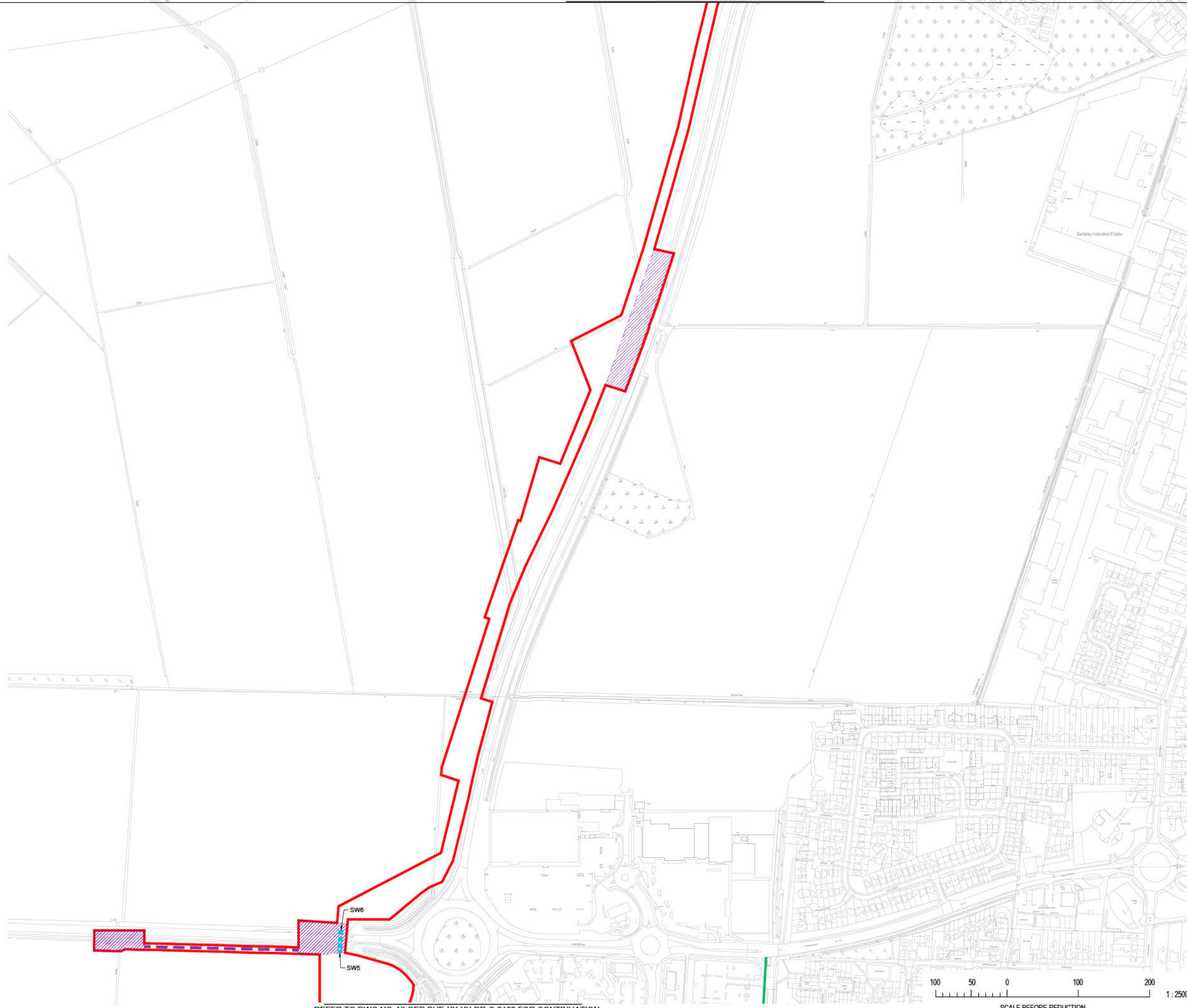
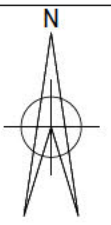

Planning Act 2008
The Infrastructure Planning (Applications: Prescribed Forms and Procedure) Regulations 2009
Regulation 12(1)

- THIS DRAWING SHOULD BE READ IN CONJUNCTION WITH ALL OTHER RELEVANT DRAWINGS AND SPECIFICATIONS.
- DRAWINGS BASED ON THE FOLLOWING BACKGROUND INFORMATION:
 - ORDNANCE SURVEY MAPS RECEIVED © CROWN COPYRIGHT AND DATABASE RIGHTS 2021 OS LICENCE 100039409
 - THE COMPLETENESS OF THE UNDERGROUND SERVICE INFORMATION CANNOT BE GUARANTEED AND THEREFORE OTHER SERVICES MAY EXIST.

LEGEND

PROPOSED

- SITE BOUNDARY
- PROPOSED STREET WORKS
- EXISTING PROW
- PROPOSED HIGHWAY
- PROPOSED PEDESTRIAN-CYCLE PATHS
- PROPOSED PEDESTRIAN PATHS
- PROPOSED STRATEGIC PEDESTRIAN-CYCLE ROUTE
- EXISTING NATIONAL CYCLE NETWORK
- HIGHWAYS TO BE STOPPED UP
- IMPROVEMENT TO EXISTING PRIVATE ACCESS TRACK/ROAD
- IMPROVEMENT TO EXISTING PRIVATE MEANS OF ACCESS
- NEW TEMPORARY PRIVATE ACCESS TRACK/ROAD
- NEW TEMPORARY PRIVATE MEANS OF ACCESS
- OPEN SPACE
- EXISTING PROW/CYCLEWAY TO BE TEMPORARILY DIVERTED OR STOPPED UP (E)
- PRIVATE ACCESS TO BE STOPPED UP (C)
- NEW PRIVATE MEANS OF ACCESS (D)

KEY:

- A - HIGHWAY STOPPING UP
- B - PROPOSED HIGHWAYS
- C - PRIVATE ACCESS TO BE STOPPED UP
- D - NEW PRIVATE MEANS OF ACCESS
- E - EXISTING PROW/CYCLEWAY TEMPORARILY DIVERTED/STOPPED UP
- FP - PROPOSED FOOTPATH
- CCF - PROPOSED COMBINED CYCLE FOOTPATH
- SW - PROPOSED STREET WORKS

Rev	Description	Date	Issd	Revisd	Appr'd
PD	ISSUED FOR DCO SUBMISSION	02.03.2022	FR	CB	CB

DCO SUBMISSION

INFORMATION

Client: NORTH LINCOLNSHIRE GREEN ENERGY PARK
Level 33, Euston Tower, 236 Euston Road, London, NW1 2DP

LD A DESIGN GSDA FICHTNER ERM

BURO HAPFOLD northern planners bowland ecology

Client: NORTH LINCOLNSHIRE GREEN ENERGY PARK LTD
Consultant: BURO HAPFOLD
Project: NORTH LINCOLNSHIRE GREEN ENERGY PARK
Dwg Title: RIGHTS OF WAY AND ACCESS PLAN SHEET 3

Planning Inspectorate No. EN010116	Scale: 1:2500
Drawn/Designed By: J.SLEEMAN	Checked By: C.BYRNE
Approved By: C.BYRNE	Revision: PO
Drawing No. NLGEP-BHE-XX-XX-DR-C-2103	

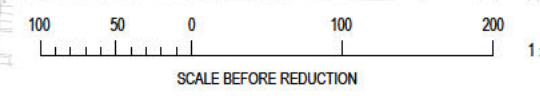

REFER TO DWG NO. NLGEP-BHE-XX-XX-DR-C-2105 FOR CONTINUATION

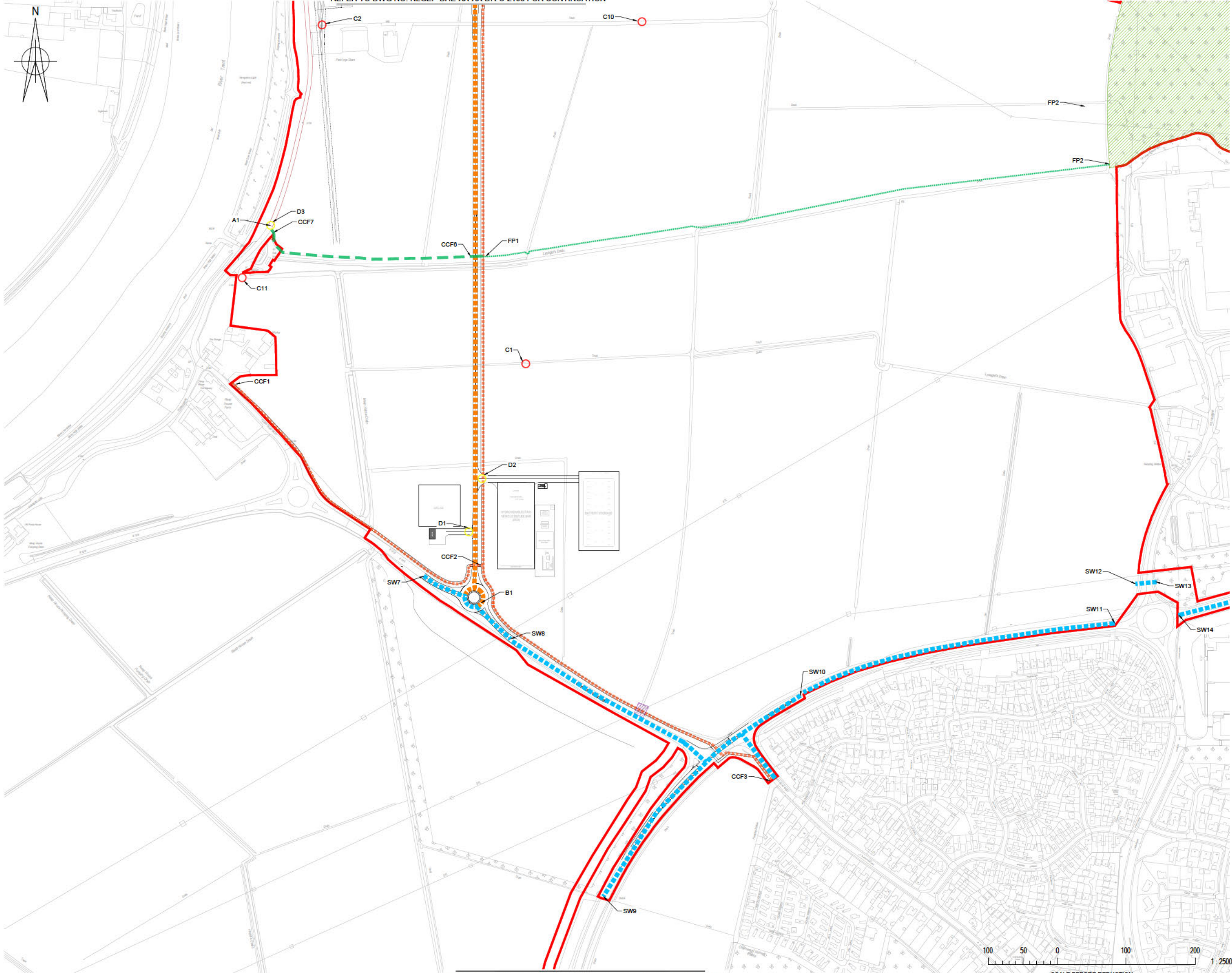

Planning Act 2008
The Infrastructure Planning (Applications: Prescribed Forms and Procedure) Regulations 2008
Regulation: 5(2)(k)

- NOTES:**
- THIS DRAWING SHOULD BE READ IN CONJUNCTION WITH ALL OTHER RELEVANT DRAWINGS AND SPECIFICATIONS.
 - DRAWINGS BASED ON THE FOLLOWING BACKGROUND INFORMATION:
 - ORDNANCE SURVEY MAPS RECEIVED © CROWN COPYRIGHT AND DATABASE RIGHTS 2021 OS LICENCE 10003409
 - THE COMPLETENESS OF THE UNDERGROUND SERVICE INFORMATION CANNOT BE GUARANTEED AND THEREFORE OTHER SERVICES MAY EXIST.

- LEGEND**
- PROPOSED**
- SITE BOUNDARY
 - PROPOSED STREET WORKS
 - EXISTING PROW
 - PROPOSED HIGHWAY
 - PROPOSED PEDESTRIAN-CYCLE PATHS
 - PROPOSED PEDESTRIAN PATHS
 - PROPOSED STRATEGIC PEDESTRIAN-CYCLE ROUTE
 - EXISTING NATIONAL CYCLE NETWORK
 - HIGHWAYS TO BE STOPPED UP
 - IMPROVEMENT TO EXISTING PRIVATE ACCESS TRACK/ROAD
 - IMPROVEMENT TO EXISTING PRIVATE MEANS OF ACCESS
 - NEW TEMPORARY PRIVATE ACCESS TRACK/ROAD
 - NEW TEMPORARY PRIVATE MEANS OF ACCESS
 - OPEN SPACE
 - EXISTING PROW/CYCLEWAY TO BE TEMPORARILY DIVERTED OR STOPPED UP (E)
 - PRIVATE ACCESS TO BE STOPPED UP (C)
 - NEW PRIVATE MEANS OF ACCESS (D)

- KEY:**
- A - HIGHWAY STOPPING UP
 - B - PROPOSED HIGHWAYS
 - C - PRIVATE ACCESS TO BE STOPPED UP
 - D - NEW PRIVATE MEANS OF ACCESS
 - E - EXISTING PROW/CYCLEWAY TEMPORARILY DIVERTED/STOPPED UP
 - FP - PROPOSED FOOTPATH
 - CCF - PROPOSED COMBINED CYCLE FOOTPATH
 - SW - PROPOSED STREET WORKS

PD	ISSUED FOR DCO SUBMISSION	01.03.2022	FR	CB	CB
Rev	Description	Date	Issd	Rev'd	App'd

DCO SUBMISSION

INFORMATION

Client: 
 Level 33, Euston Tower, 206 Euston Road, London, NW1 2DP

LD A DESIGN GSDA FICHTNER
 ERM CONSULTING ENGINEERS LTD

BURO HAPFOLD northern planners bowland ecology

Client: NORTH LINCOLNSHIRE GREEN ENERGY PARK LTD
 Consultant: BURO HAPFOLD
 Project: NORTH LINCOLNSHIRE GREEN ENERGY PARK
 Title: RIGHTS OF WAY AND ACCESS PLAN SHEET 4

Planning Inspectorate No. EN010116	Scale: 1:2500
Drawn/Designed By: J.SLEEMAN	Checked By: C.BYRNE
Approved By: C.BYRNE	Revision: PO
Drawing No. NLGEP-BHE-XX-XX-DR-C-2104	

REFER TO DWG NO. NLGEP-BHE-XX-XX-DR-C-2103 FOR CONTINUATION

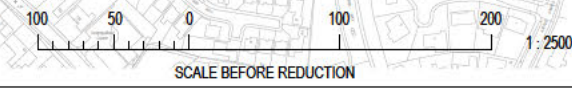



- NOTES:**
- THIS DRAWING SHOULD BE READ IN CONJUNCTION WITH ALL OTHER RELEVANT DRAWINGS AND SPECIFICATIONS.
 - DRAWINGS BASED ON THE FOLLOWING BACKGROUND INFORMATION:
 - ORDNANCE SURVEY MAPS RECEIVED © CROWN COPYRIGHT AND DATABASE RIGHTS 2021 OS LICENCE 100035409
 - THE COMPLETENESS OF THE UNDERGROUND SERVICE INFORMATION CANNOT BE GUARANTEED AND THEREFORE OTHER SERVICES MAY EXIST.

- LEGEND**
- PROPOSED**
- SITE BOUNDARY
 - PROPOSED STREET WORKS
 - EXISTING PROW
 - PROPOSED HIGHWAY
 - PROPOSED PEDESTRIAN-CYCLE PATHS
 - PROPOSED PEDESTRIAN PATHS
 - PROPOSED STRATEGIC PEDESTRIAN-CYCLE ROUTE
 - EXISTING NATIONAL CYCLE NETWORK
 - HIGHWAYS TO BE STOPPED UP
 - IMPROVEMENT TO EXISTING PRIVATE ACCESS TRACK/ROAD
 - IMPROVEMENT TO EXISTING PRIVATE MEANS OF ACCESS
 - NEW TEMPORARY PRIVATE ACCESS TRACK/ROAD
 - NEW TEMPORARY PRIVATE MEANS OF ACCESS
 - OPEN SPACE
 - EXISTING PROW/CYCLEWAY TO BE TEMPORARILY DIVERTED OR STOPPED UP (E)
 - PRIVATE ACCESS TO BE STOPPED UP (C)
 - NEW PRIVATE MEANS OF ACCESS (D)

- KEY:**
- A - HIGHWAY STOPPING UP
 - B - PROPOSED HIGHWAYS
 - C - PRIVATE ACCESS TO BE STOPPED UP
 - D - NEW PRIVATE MEANS OF ACCESS
 - E - EXISTING PROW/CYCLEWAY TEMPORARILY DIVERTED/STOPPED UP
 - FP - PROPOSED FOOTPATH
 - CCF - PROPOSED COMBINED CYCLE FOOTPATH
 - SW - PROPOSED STREET WORKS

REFER TO DWG NO. NLGEP-BHE-XX-XX-DR-C-2106 FOR CONTINUATION

PD	ISSUED FOR DCO SUBMISSION	01.03.2022	FR	CB	CB
Rev	Description	Date	Issd	Rev'd	App'd

DCO SUBMISSION

Project Stage

INFORMATION

Status of Drawing

Client



Level 33, Euston Tower, 206 Euston Road, London, NW1 2DP

LD A DESIGN GSDA FICHTNER ERM

BURO HAPFOLD northern planners bowland ecology

Client: NORTH LINCOLNSHIRE GREEN ENERGY PARK LTD
 Consultant: BURO HAPFOLD
 Project: NORTH LINCOLNSHIRE GREEN ENERGY PARK
 Draw Title: RIGHTS OF WAY AND ACCESS PLAN SHEET 5

EN010116	Scale: 1:2500
Drawn/Designed By: J.SLEEMAN	Checked By: C.BYRNE
Approved By: C.BYRNE	Revision: PO
Drawing No: NLGEP-BHE-XX-XX-DR-C-2105	Revision: PO

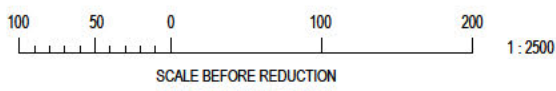

REFER TO DWG NO. NLGEP-BHE-XX-XX-DR-C-2104 FOR CONTINUATION

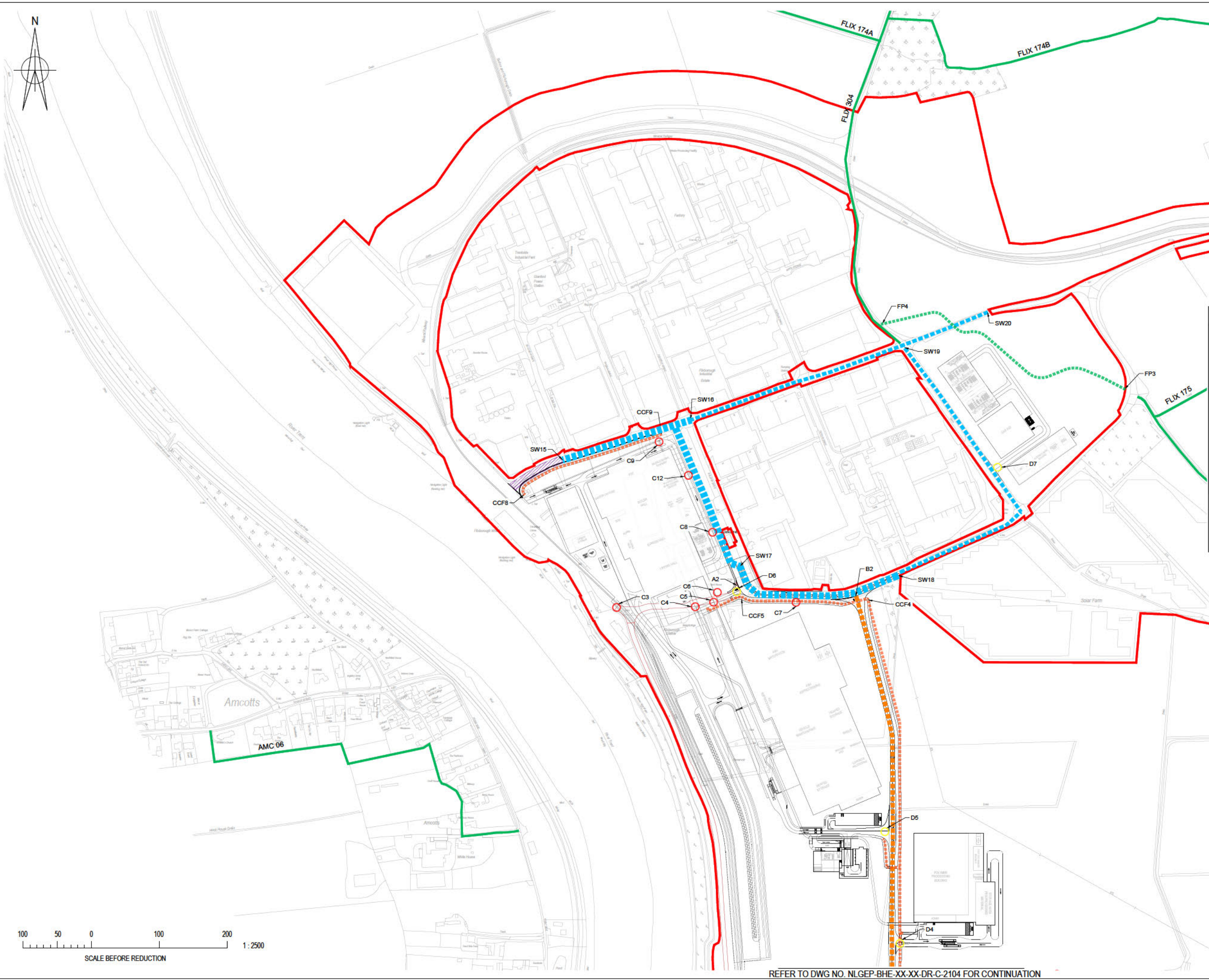

REFER TO DWG NO. NLGEP-BHE-XX-XX-DR-C-2105 FOR CONTINUATION

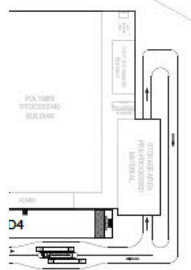
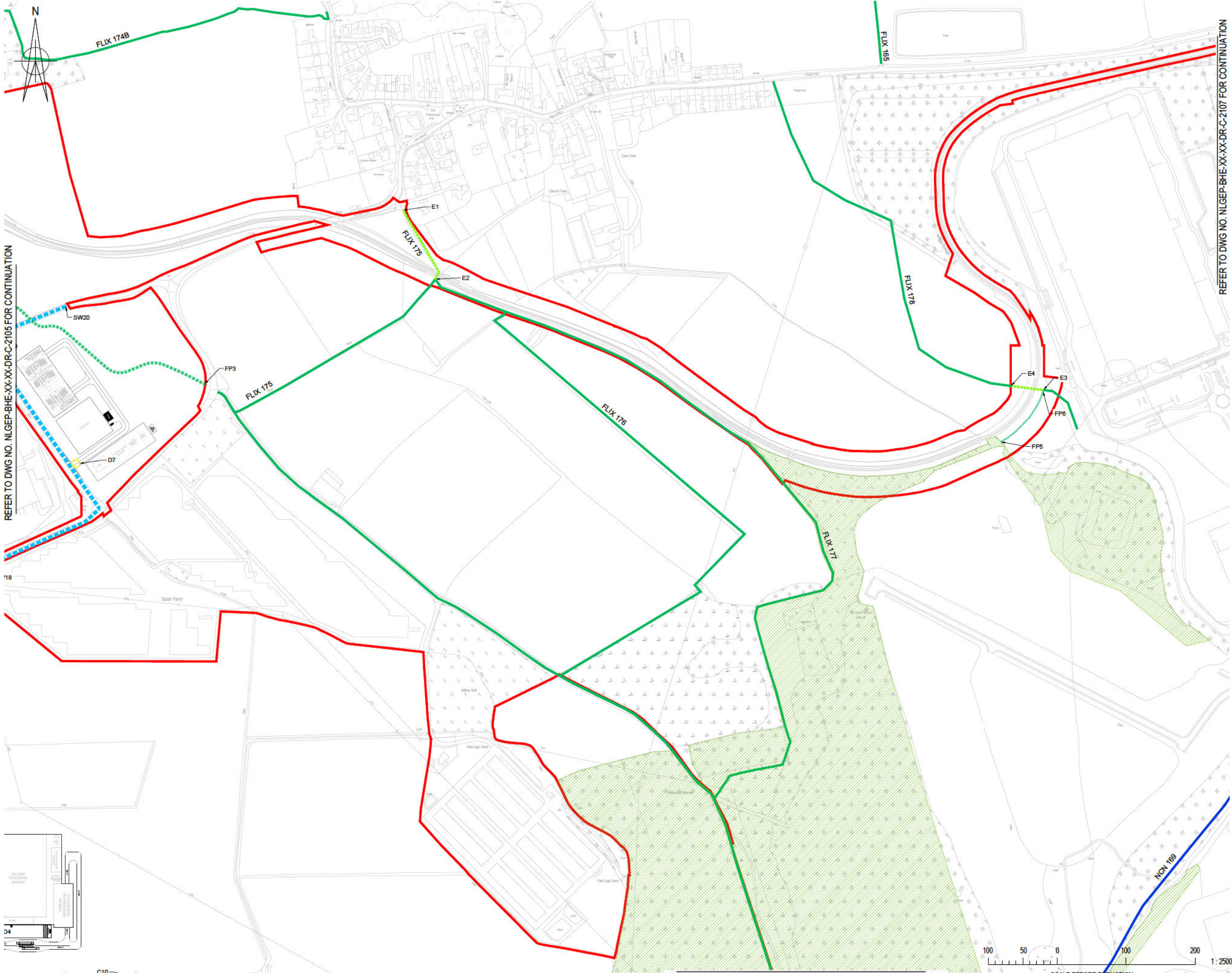

Planning Act 2008
The Infrastructure Planning (Applications: Prescribed Forms and Procedure) Regulations 2008
Regulation: 5(2)(k)

NOTES:

- THIS DRAWING SHOULD BE READ IN CONJUNCTION WITH ALL OTHER RELEVANT DRAWINGS AND SPECIFICATIONS.
- DRAWINGS BASED ON THE FOLLOWING BACKGROUND INFORMATION:
 - ORDNANCE SURVEY MAPS RECEIVED © CROWN COPYRIGHT AND DATABASE RIGHTS 2021 OS LICENCE 100035409
- THE COMPLETENESS OF THE UNDERGROUND SERVICE INFORMATION CANNOT BE GUARANTEED AND THEREFORE OTHER SERVICES MAY EXIST.

LEGEND

PROPOSED

- SITE BOUNDARY
- PROPOSED STREET WORKS
- EXISTING PROW
- PROPOSED HIGHWAY
- PROPOSED PEDESTRIAN-CYCLE PATHS
- PROPOSED PEDESTRIAN PATHS
- PROPOSED STRATEGIC PEDESTRIAN-CYCLE ROUTE
- EXISTING NATIONAL CYCLE NETWORK
- HIGHWAYS TO BE STOPPED UP
- IMPROVEMENT TO EXISTING PRIVATE ACCESS TRACKROAD
- IMPROVEMENT TO EXISTING PRIVATE MEANS OF ACCESS
- NEW TEMPORARY PRIVATE ACCESS TRACKROAD
- NEW TEMPORARY PRIVATE MEANS OF ACCESS
- OPEN SPACE
- EXISTING PROWCYCLEWAY TO BE TEMPORARILY DIVERTED OR STOPPED UP (E)
- PRIVATE ACCESS TO BE STOPPED UP (C)
- NEW PRIVATE MEANS OF ACCESS (D)

KEY:

- A - HIGHWAY STOPPING UP
- B - PROPOSED HIGHWAYS
- C - PRIVATE ACCESS TO BE STOPPED UP
- D - NEW PRIVATE MEANS OF ACCESS
- E - EXISTING PROWCYCLEWAY TEMPORARILY DIVERTED/STOPPED UP
- FP - PROPOSED FOOTPATH
- CCF - PROPOSED COMBINED CYCLE FOOTPATH
- SW - PROPOSED STREET WORKS

REFER TO DWG NO. NLGEP-BHE-XX-XX-DR-C-2107 FOR CONTINUATION

P0 ISSUED FOR DCO SUBMISSION 02.03.2022 FR CB CB

Rev	Description	Date	Issd	Rev'd	App'd

DCO SUBMISSION

Project Stage

INFORMATION

Status of Drawing

Client

Client: NORTH LINCOLNSHIRE GREEN ENERGY PARK LTD
 Consultant: BURO HAPPOLD
 Project: NORTH LINCOLNSHIRE GREEN ENERGY PARK
 Title: RIGHTS OF WAY AND ACCESS PLAN SHEET 6

Planning Inspectorate No. EN010116	Scale: 1:2500
Drawn/Designed By: J.SLEEMAN	Checked By: C.BYRNE
Approved By: C.BYRNE	
Drawing No. NLGEP-BHE-XX-XX-DR-C-2106	Revision: P0

REFER TO DWG NO. NLGEP-BHE-XX-XX-DR-C-2109 FOR CONTINUATION



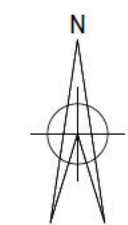

REFER TO DWG NO. NLGEP-BHE-XX-XX-DR-C-2108 FOR CONTINUATION

REFER TO DWG NO. NLGEP-BHE-XX-XX-DR-C-2108 FOR CONTINUATION

Planning Act 2008
The Infrastructure Planning (Applications: Prescribed Forms and Procedure) Regulations 2008
Regulation: 5(2)(k)

- NOTES:**
- THIS DRAWING SHOULD BE READ IN CONJUNCTION WITH ALL OTHER RELEVANT DRAWINGS AND SPECIFICATIONS.
 - DRAWINGS BASED ON THE FOLLOWING BACKGROUND INFORMATION:
 - ORDNANCE SURVEY MAPS RECEIVED @ CROWN COPYRIGHT AND DATABASE RIGHTS 2021 OS LICENCE 100035409
 - THE COMPLETENESS OF THE UNDERGROUND SERVICE INFORMATION CANNOT BE GUARANTEED AND THEREFORE OTHER SERVICES MAY EXIST.

- LEGEND**
- PROPOSED**
- SITE BOUNDARY
 - PROPOSED STREET WORKS
 - EXISTING PROW
 - PROPOSED HIGHWAY
 - PROPOSED PEDESTRIAN-CYCLE PATHS
 - PROPOSED PEDESTRIAN PATHS
 - PROPOSED STRATEGIC PEDESTRIAN-CYCLE ROUTE
 - EXISTING NATIONAL CYCLE NETWORK
 - HIGHWAYS TO BE STOPPED UP
 - IMPROVEMENT TO EXISTING PRIVATE ACCESS TRACK/ROAD
 - IMPROVEMENT TO EXISTING PRIVATE MEANS OF ACCESS
 - NEW TEMPORARY PRIVATE ACCESS TRACK/ROAD
 - NEW TEMPORARY PRIVATE MEANS OF ACCESS
 - OPEN SPACE
 - EXISTING PROW/CYCLEWAY TO BE TEMPORARILY DIVERTED OR STOPPED UP (E)
 - PRIVATE ACCESS TO BE STOPPED UP (C)
 - NEW PRIVATE MEANS OF ACCESS (D)

- KEY:**
- A - HIGHWAY STOPPING UP
 - B - PROPOSED HIGHWAYS
 - C - PRIVATE ACCESS TO BE STOPPED UP
 - D - NEW PRIVATE MEANS OF ACCESS
 - E - EXISTING PROW/CYCLEWAY TEMPORARILY DIVERTED/STOPPED UP
 - FP - PROPOSED FOOTPATH
 - CCF - PROPOSED COMBINED CYCLE FOOTPATH
 - SW - PROPOSED STREET WORKS

PD ISSUED FOR DCO SUBMISSION 02.03.2022 FR CB CB

Rev	Description	Date	Issd	Rev'd	Agree

DCO SUBMISSION

Project Stage

INFORMATION

Status of Drawing

Client



Level 33, Euston Tower, 206 Euston Road, London, NW1 2DP

LD A DESIGN GSDA FICHTNER ERM

BURO HAPFOLD northern planners bowland ecology

Client: NORTH LINCOLNSHIRE GREEN ENERGY PARK LTD
 Consultant: BURO HAPFOLD
 Project: NORTH LINCOLNSHIRE GREEN ENERGY PARK
 Title: RIGHTS OF WAY AND ACCESS PLAN SHEET 7

Planning Inspectorate No. EN010116 Scale: 1:2500
 Drawn/Designed By: J.SLEEMAN Checked By: C.BYRNE Approved By: C.BYRNE
 Drawing No. NLGEP-BHE-XX-XX-DR-C-2107

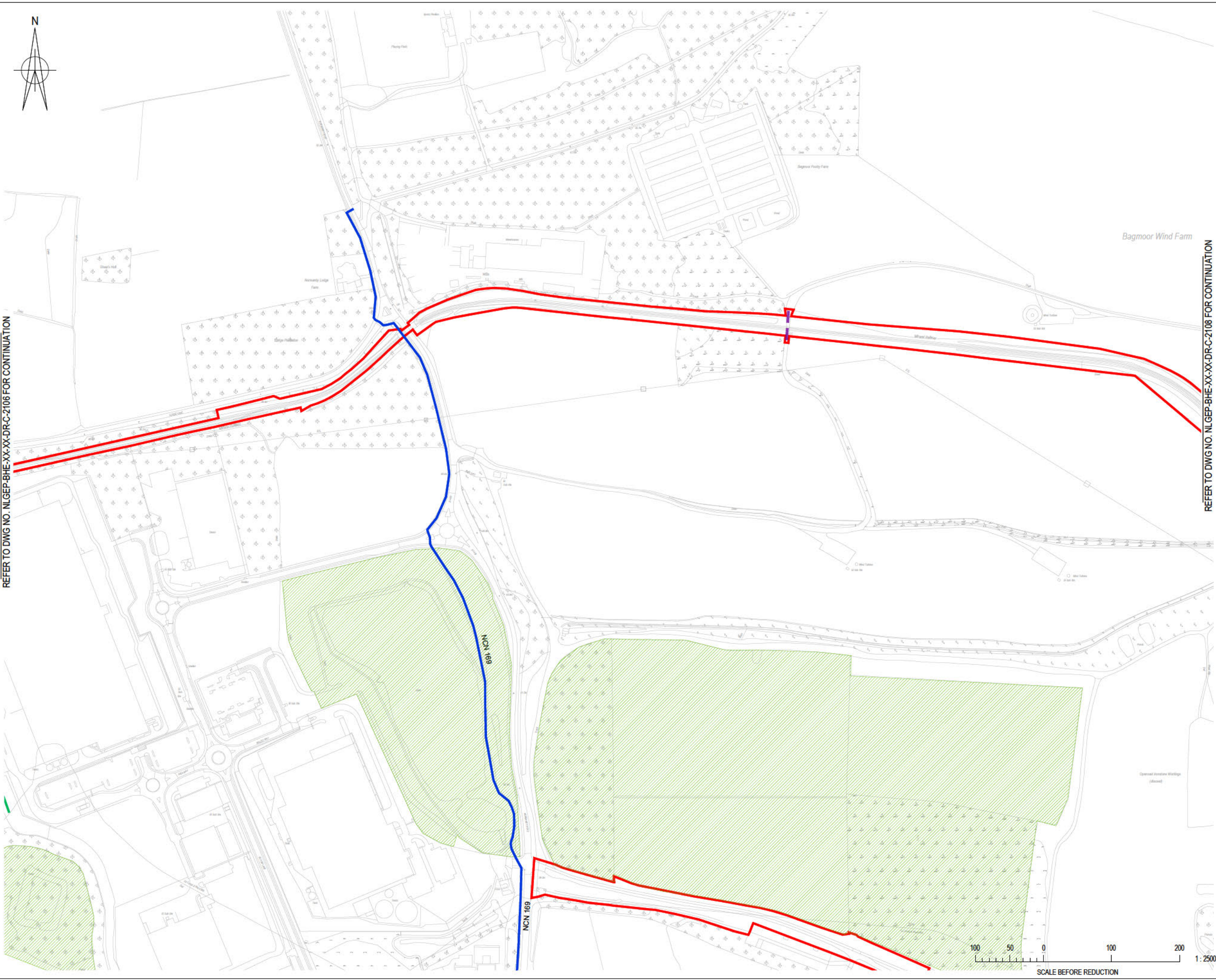
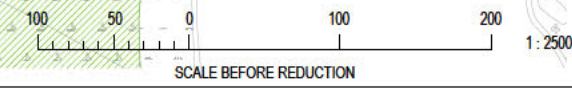



Planning Act 2008
The Infrastructure Planning (Applications: Prescribed Forms and Procedure) Regulations 2008
Regulation: 5(2)(k)

- NOTES:**
- THIS DRAWING SHOULD BE READ IN CONJUNCTION WITH ALL OTHER RELEVANT DRAWINGS AND SPECIFICATIONS.
 - DRAWINGS BASED ON THE FOLLOWING BACKGROUND INFORMATION:
 - ORDNANCE SURVEY MAPS RECEIVED @ CROWN COPYRIGHT AND DATABASE RIGHTS 2021 OS LICENCE 10003409
 - THE COMPLETENESS OF THE UNDERGROUND SERVICE INFORMATION CANNOT BE GUARANTEED AND THEREFORE OTHER SERVICES MAY EXIST.

- LEGEND**
- PROPOSED**
- SITE BOUNDARY
 - PROPOSED STREET WORKS
 - EXISTING PROW
 - PROPOSED HIGHWAY
 - PROPOSED PEDESTRIAN-CYCLE PATHS
 - PROPOSED PEDESTRIAN PATHS
 - PROPOSED STRATEGIC PEDESTRIAN-CYCLE ROUTE
 - EXISTING NATIONAL CYCLE NETWORK
 - HIGHWAYS TO BE STOPPED UP
 - IMPROVEMENT TO EXISTING PRIVATE ACCESS TRACK/ROAD
 - IMPROVEMENT TO EXISTING PRIVATE MEANS OF ACCESS
 - NEW TEMPORARY PRIVATE ACCESS TRACK/ROAD
 - NEW TEMPORARY PRIVATE MEANS OF ACCESS
 - OPEN SPACE
 - EXISTING PROWCYCLEWAY TO BE TEMPORARILY DIVERTED OR STOPPED UP (E)
 - PRIVATE ACCESS TO BE STOPPED UP (C)
 - NEW PRIVATE MEANS OF ACCESS (D)

- KEY:**
- A - HIGHWAY STOPPING UP
 - B - PROPOSED HIGHWAYS
 - C - PRIVATE ACCESS TO BE STOPPED UP
 - D - NEW PRIVATE MEANS OF ACCESS
 - E - EXISTING PROWCYCLEWAY TEMPORARILY DIVERTED/STOPPED UP
 - FP - PROPOSED FOOTPATH
 - CCF - PROPOSED COMBINED CYCLE FOOTPATH
 - SW - PROPOSED STREET WORKS

PD ISSUED FOR DCO SUBMISSION 02.03.2022 FR CB CB

Rev	Description	Date	Issd	Rev'd	App'd

DCO SUBMISSION

Project Stage

INFORMATION

Status of Drawing

Client



Level 33, Euston Tower, 236 Euston Road, London, NW1 2DP

LD A DESIGN GSDA FICHTNER ERM

BURO HAPFOLD northern planners bowland ecology

Client: NORTH LINCOLNSHIRE GREEN ENERGY PARK LTD
 Consultant: BURO HAPFOLD
 Project: NORTH LINCOLNSHIRE GREEN ENERGY PARK
 Title: RIGHTS OF WAY AND ACCESS PLAN SHEET 8

Planning Inspectorate No. EN010116 Scale: 1:2500
 Drawing No. NLGEP-BHE-XX-XX-DR-C-2108
 Design/Drawn By: J.SLEEMAN Checked By: C.BYRNE Approved By: C.BYRNE
 Revision: PO

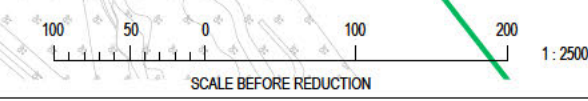



Planning Act 2008
The Infrastructure Planning (Applications: Prescribed Forms and Procedure) Regulations 2008
Regulation: 5(2)(k)

- NOTES:**
- THIS DRAWING SHOULD BE READ IN CONJUNCTION WITH ALL OTHER RELEVANT DRAWINGS AND SPECIFICATIONS.
 - DRAWINGS BASED ON THE FOLLOWING BACKGROUND INFORMATION:
 - ORDNANCE SURVEY MAPS RECEIVED © CROWN COPYRIGHT AND DATABASE RIGHTS 2021 OS LICENCE 10003409
 - THE COMPLETENESS OF THE UNDERGROUND SERVICE INFORMATION CANNOT BE GUARANTEED AND THEREFORE OTHER SERVICES MAY EXIST.

- LEGEND**
- PROPOSED**
- SITE BOUNDARY
 - PROPOSED STREET WORKS
 - EXISTING PROW
 - PROPOSED HIGHWAY
 - PROPOSED PEDESTRIAN-CYCLE PATHS
 - PROPOSED PEDESTRIAN PATHS
 - PROPOSED STRATEGIC PEDESTRIAN-CYCLE ROUTE
 - EXISTING NATIONAL CYCLE NETWORK
 - HIGHWAYS TO BE STOPPED UP
 - IMPROVEMENT TO EXISTING PRIVATE ACCESS TRACK/ROAD
 - IMPROVEMENT TO EXISTING PRIVATE MEANS OF ACCESS
 - NEW TEMPORARY PRIVATE ACCESS TRACK/ROAD
 - NEW TEMPORARY PRIVATE MEANS OF ACCESS
 - OPEN SPACE
 - EXISTING PROW/CYCLEWAY TO BE TEMPORARILY DIVERTED OR STOPPED UP (E)
 - PRIVATE ACCESS TO BE STOPPED UP (C)
 - NEW PRIVATE MEANS OF ACCESS (D)

- KEY:**
- A - HIGHWAY STOPPING UP
 - B - PROPOSED HIGHWAYS
 - C - PRIVATE ACCESS TO BE STOPPED UP
 - D - NEW PRIVATE MEANS OF ACCESS
 - E - EXISTING PROW/CYCLEWAY TEMPORARILY DIVERTED/STOPPED UP
 - FP - PROPOSED FOOTPATH
 - CCF - PROPOSED COMBINED CYCLE FOOTPATH
 - SW - PROPOSED STREET WORKS

PD	ISSUED FOR DCO SUBMISSION	02.03.2022	FR	CB	CB
Rev	Description	Date	Issd	Rev'd	App'd

DCO SUBMISSION

Project Stage

INFORMATION

Status of Drawing

Client

Level 33, Euston Tower, 206 Euston Road, London, NW1 2DP

LD A DESIGN GSDA FICHTNER ERM

BURO HAPFOLD northern planners bowland ecology

Client: NORTH LINCOLNSHIRE GREEN ENERGY PARK LTD
 Consultant: BURO HAPFOLD
 Project: NORTH LINCOLNSHIRE GREEN ENERGY PARK
 Drawing Title: RIGHTS OF WAY AND ACCESS PLAN SHEET 9

Planning Inspectorate No. EN010116	Scale: 1:2500
Drawn/Designed By: J.SLEEMAN	Checked By: C.BYRNE
Approved By: C.BYRNE	Revision: PO
Drawing No. NLGEP-BHE-XX-XX-DR-C-2109	

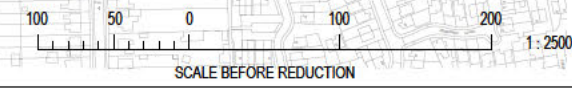

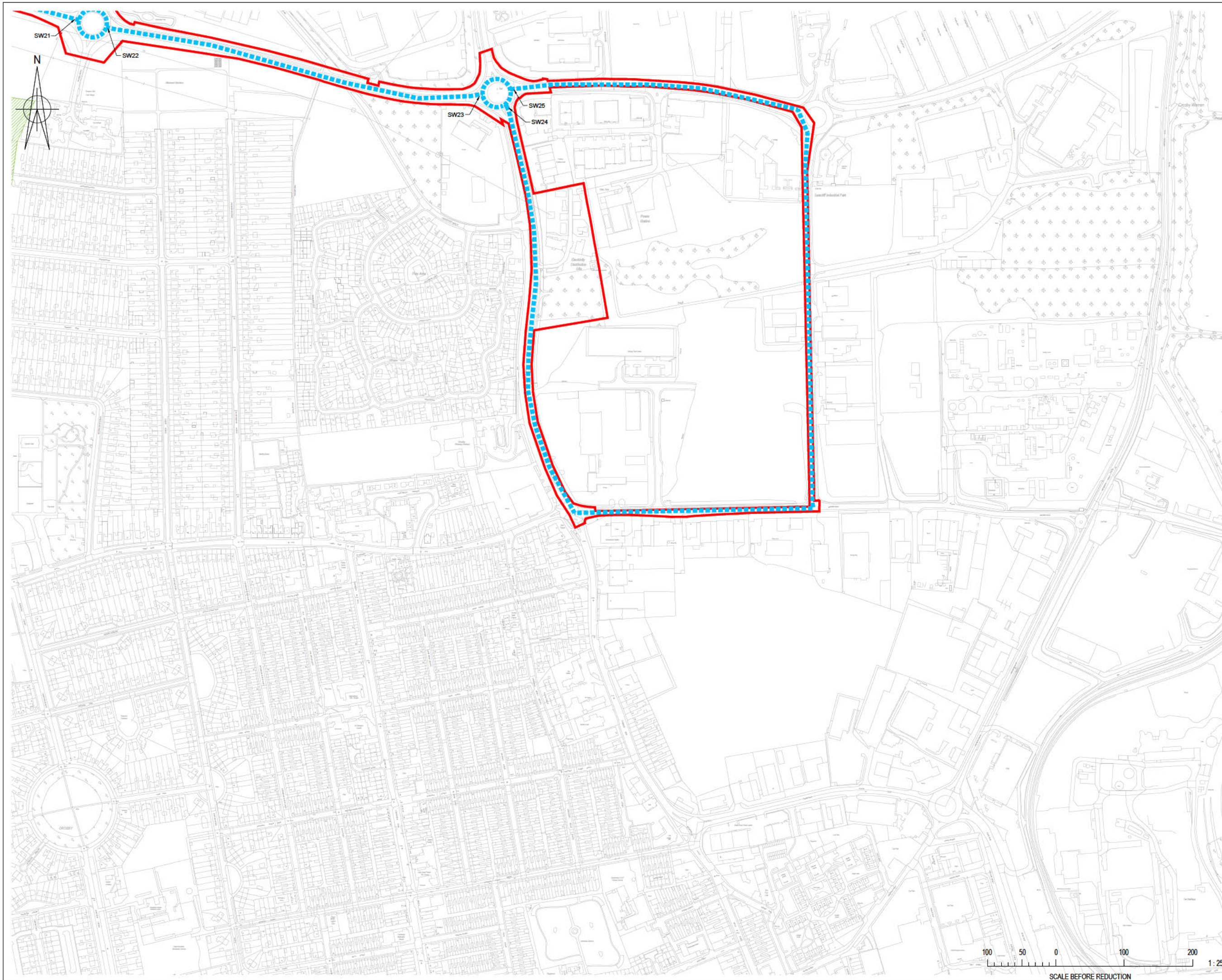

- NOTES:**
- THIS DRAWING SHOULD BE READ IN CONJUNCTION WITH ALL OTHER RELEVANT DRAWINGS AND SPECIFICATIONS.
 - DRAWINGS BASED ON THE FOLLOWING BACKGROUND INFORMATION:
 - ORDNANCE SURVEY MAPS RECEIVED © CROWN COPYRIGHT AND DATABASE RIGHTS 2021 OS LICENCE 100035409
 - THE COMPLETENESS OF THE UNDERGROUND SERVICE INFORMATION CANNOT BE GUARANTEED AND THEREFORE OTHER SERVICES MAY EXIST.

- LEGEND**
- PROPOSED**
- SITE BOUNDARY
 - PROPOSED STREET WORKS
 - EXISTING PROW
 - PROPOSED HIGHWAY
 - PROPOSED PEDESTRIAN-CYCLE PATHS
 - PROPOSED PEDESTRIAN PATHS
 - PROPOSED STRATEGIC PEDESTRIAN-CYCLE ROUTE
 - EXISTING NATIONAL CYCLE NETWORK
 - HIGHWAYS TO BE STOPPED UP
 - IMPROVEMENT TO EXISTING PRIVATE ACCESS TRACK/ROAD
 - IMPROVEMENT TO EXISTING PRIVATE MEANS OF ACCESS
 - NEW TEMPORARY PRIVATE ACCESS TRACK/ROAD
 - NEW TEMPORARY PRIVATE MEANS OF ACCESS
 - OPEN SPACE
 - EXISTING PROW/CYCLEWAY TO BE TEMPORARILY DIVERTED OR STOPPED UP (E)
 - PRIVATE ACCESS TO BE STOPPED UP (C)
 - NEW PRIVATE MEANS OF ACCESS (D)

- KEY:**
- A - HIGHWAY STOPPING UP
 - B - PROPOSED HIGHWAYS
 - C - PRIVATE ACCESS TO BE STOPPED UP
 - D - NEW PRIVATE MEANS OF ACCESS
 - E - EXISTING PROW/CYCLEWAY TEMPORARILY DIVERTED/STOPPED UP
 - FP - PROPOSED FOOTPATH
 - CCF - PROPOSED COMBINED CYCLE FOOTPATH
 - SW - PROPOSED STREET WORKS

PD	ISSUED FOR DCO SUBMISSION	02.03.2022	FR	CB	CB
Rev	Description	Date	Issd	Rev'd	App'd

DCO SUBMISSION

Project Stage

INFORMATION

Status of Drawing

Client



Level 33, Euston Tower, 206 Euston Road, London, NW1 2DP

LD A DESIGN GSDA FICHTNER ERM

BURO HAPFOLD northern planners bowland ecology

Client: NORTH LINCOLNSHIRE GREEN ENERGY PARK LTD
 Consultant: BURO HAPFOLD
 Project: NORTH LINCOLNSHIRE GREEN ENERGY PARK
 Title: RIGHTS OF WAY AND ACCESS PLAN SHEET 10

Planning Inspectorate No. EN010116	Scale: 1:2500
Drawn/Designed By: J.SLEEMAN	Checked By: C.BYRNE
Approved By: C.BYRNE	Revision: PO
Drawing No. NLGEP-BHE-XX-XX-DR-C-2110	

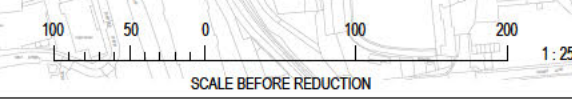

this page is intentionally blank

Appendix F Construction Traffic Forecasts

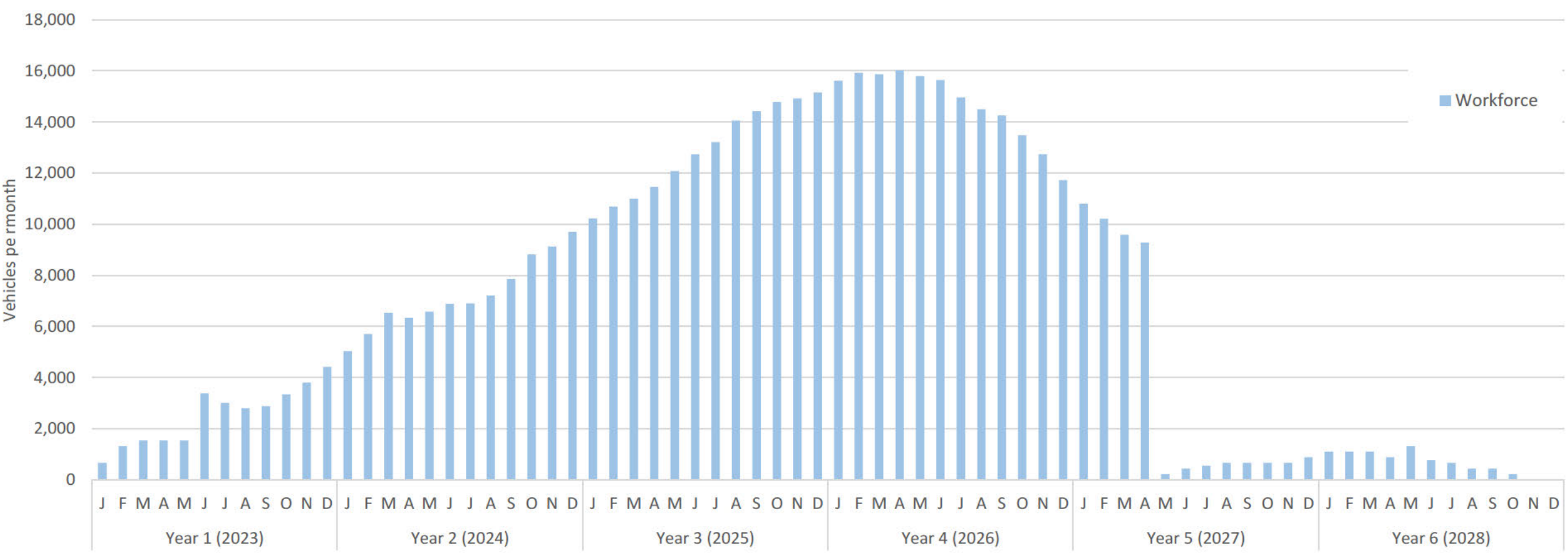
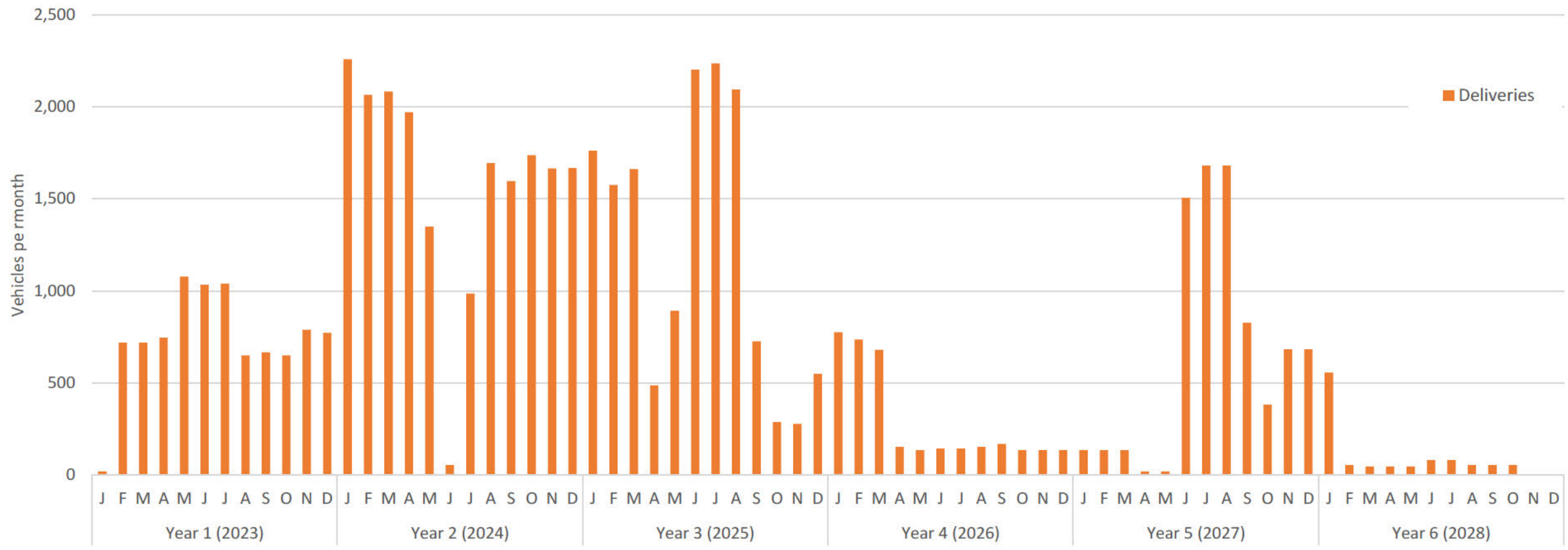

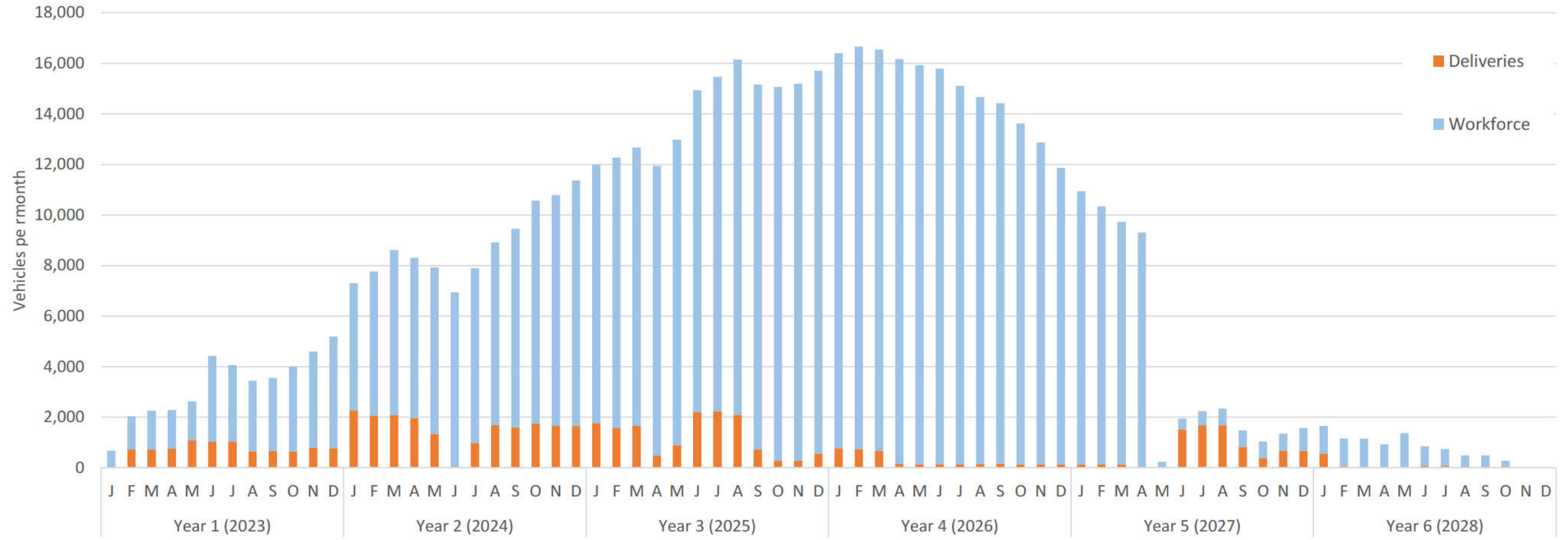

this page is intentionally blank

Buro Happold Limited
17 Newman Street
London
W1T 1PD
UK

T: +44 (0)207 927 9700

